



Quick Overview of Prices

2024/2025

- > Fireplaces
- > Urfeuer- open fireplace
- > Tiled stoves
- > Masonry heaters
- > KSO
- > BSO
- > BSK
- > BSG
- > Boiler
- > Iron Dog
- > Grilling and baking
- > MAS/MSS/GNF
- > USA/EOS/EAS

BRUNNER[®]

made in germany.

Price validity from 01.07.2024 to 30.06.2025.

All prices mentioned in this pricelist are in Euro.

Recommended retail prices excl. value-added tax.

This Quick Overview of Prices is an abstract of our main Pricelist 2024/2025.

It shows the most popular product combinations.

Of course, all products can be set up individually depending on your needs (refer to our main Pricelist 2024/2025).

This pricelist is not intended for the end customer.

Eventual typesetting errors or interim modifications of any kind are not considered to be reasons for a claim.

All contracts, deliveries and other services are subject to our "General terms and conditions of business".

Subject to technical changes; errors excepted.

Content

	Page
Fireplaces	5
Urfeuer- open fireplace	98
Tiled stoves	114
Masonry heaters	170
KSO	190
BSO	196
BSK	220
BSG	262
Boiler	276
Iron Dog	336
Grilling and baking	342
MAS, MSS, GNF	346
USA, EOS, EAS	390

Abbreviation - explication

DT	side-opening door
ST	lifting door
KT	tilting door
F	flat glass
R	round glass
DV	double glazing
EV	single glazing
Details for the corner fireplaces	
STR	lifting door right corner
STL	lifting door left corner
1T	one piece glass pane
2T	two-piece glass pane
Indications for inserts with additional door DHT	
DHTR	additional charging door, right side
DHTL	additional charging door, left side
DHTM	additional charging door, middle
Attention: the position of the DHT is always viewed from the glass pane side of the unit	
Indications for Tunnel inserts	
DT-DT	side opening door-side opening door (on both sides side opening)
DT-ST	side opening-lifting door (one side to open-one side to lift)
ST-KT	lifting-tilting door (one side to lift the other side to tilt)
ST-ST	lifting - lifting door (on both sides to lift)
Door hinge HKD 4.1/5.1/6.1 and front set B7/B8	
SSL	self closing left-hand stop
SSR	self closing right-hand stop
NSSL	non self closing left-hand stop
NSSR	not self-closing right-hand stop
GK	ceramic glass
GKB	ceramic glass coated
GKG	ceramic glass tinted
FR	Chamotte inner lining set
FR/Guss	Combustion chamber inner lining cast iron

Glazing formats series 5.0

Flat glazing

from page 12

flat

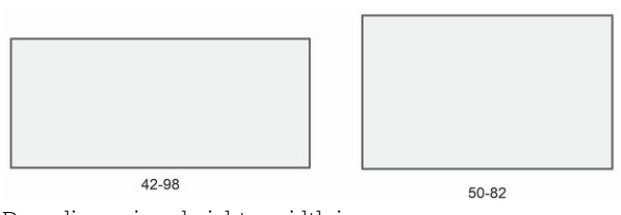
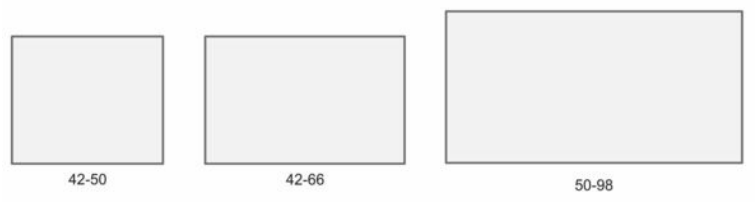

Door dimensions height x width in cm

Tunnel formats

from page 34

Tunnel

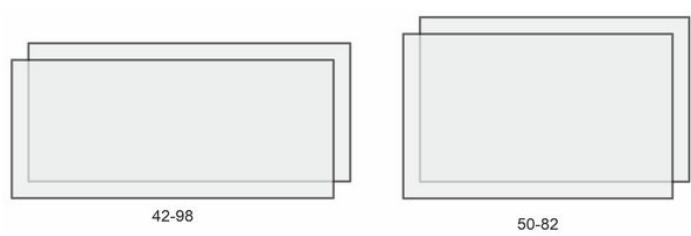
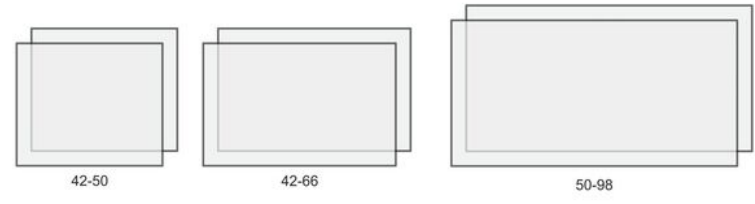

Door dimensions height x width in cm

Eck

Panorama

Eck corners

flat

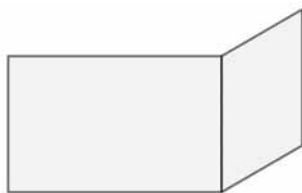

42-66-42

Tunnel

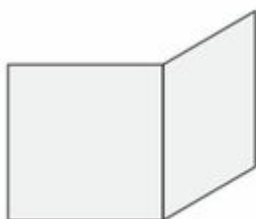

42-42-42



42-98-42



50-82-42

Door dimensions height x width x width in cm

Eck

Panorama

Door frame - mounting frame series 5.0

lifting door

with mounting frame

with door frame

side-opening door

with mounting bracket

with door frame



Smoke hood variants series 5.0



Cast iron dome



Cast iron dome with heat exchanger rings



Cast iron dome low



Modular Accumulator MAS

Equipment EAS series 5.0

Preassembled EAS components, door switch, thermocouple, air connection box D=125 with motor transmission

Glazing formats Series 4.1

Flat glazing

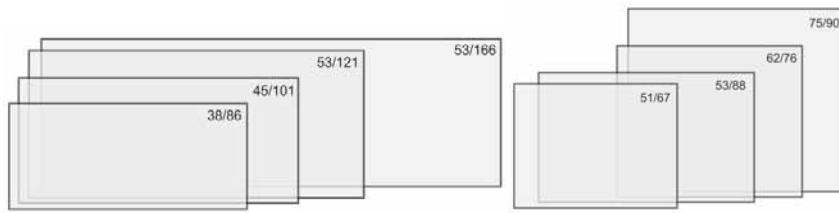

Architektur-Kamin

Stil-Kamin

Door dimensions height x width in cm

from
page
12

Tunnel formats

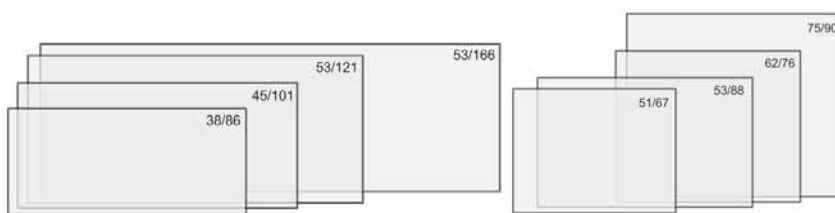

Architektur-Kamin

Stil-Kamin

Door dimensions height x width in cm

from
page
34

Eck corners

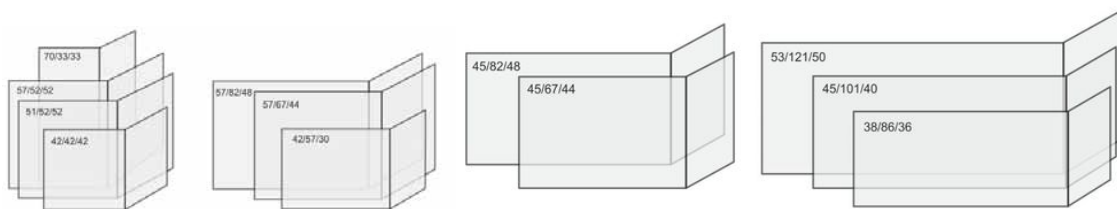

Eck-Kamin

Architektur-Eck- fireplace

Door dimensions height x width x width in cm

from
page
54

Panorama formats

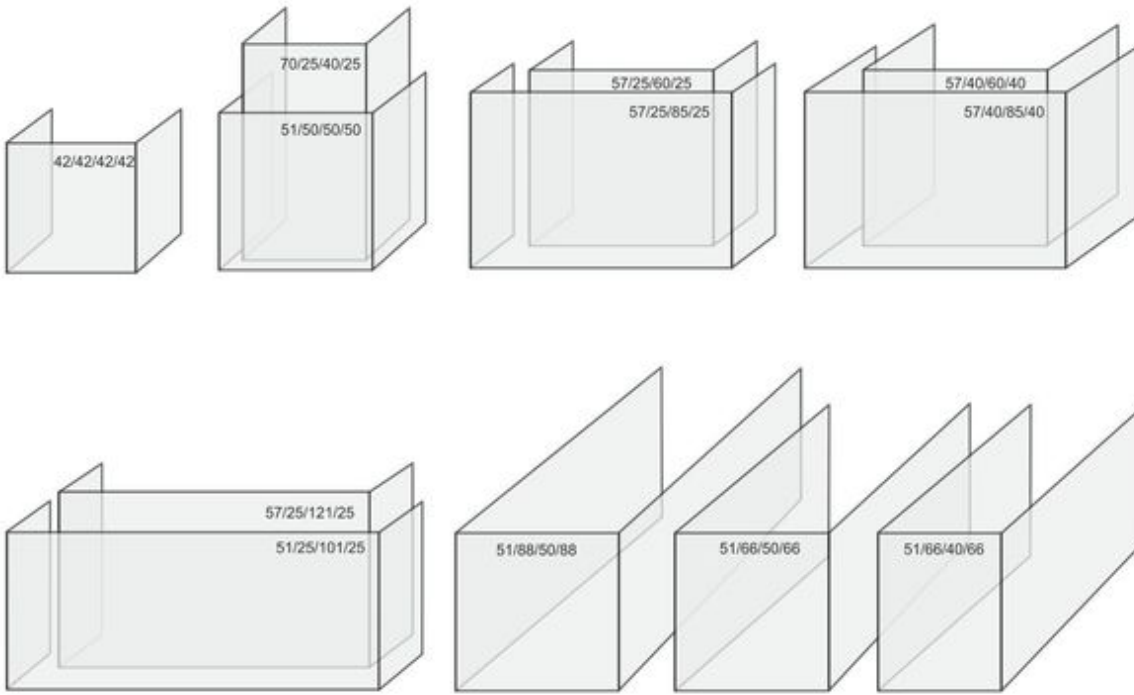

Door dimensions height x side width x front width x side width in cm

Door frame - mounting frame Series 4.1

flat



Door frame



Mounting frame 50 mm



Mounting frame 70 mm

Tunnel

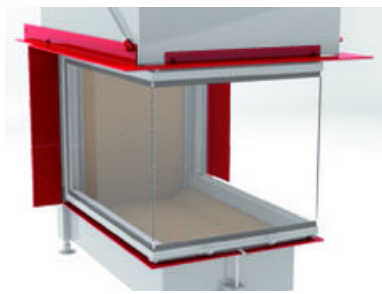

Panorama narrow frame

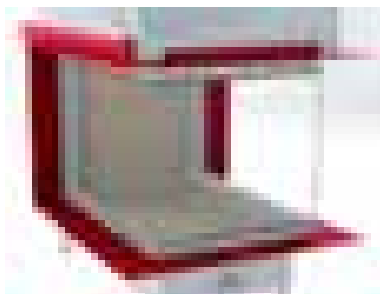

Panorama wide frame (Fire table)

Eck

Panorama

Smoke hood variants Series 4.1



Cast iron hot air hood ø 200 mm



Cast iron dome



Modular Accumulator MAS

Supplementary equipment

- EAS** Combustion controls with potential-free relay (without additional functions) consisting of display, 1 x flush-mount box, door switch, thermocouple & bus line, each 2 m long. Preassembled EAS/EOS components, door switch, thermocouple, motor box with transmission and ø 125 mm air flap, flexible hose with adjustable clamps

- EOS** Combustion control with graphic touchscreen display and additional functions (differential temperature control, Moritz's flap control) consisting of: Display with control unit, 2 x flush-mount box, door switch, thermocouple, bus and connecting line, each 2 m long, 4 x water sensors with immersion sleeve and 2x extension cable 3 m. Preassembled EOS components: door switch, thermocouple, motor box with transmission and ø 125 mm air flap, flexible hose with adjustable clamps

flat

Tunnel

Eck

Panorama





BKH 5.0 flat 42-50 DT

Set consists of:	Art.-Nr.	No.	Price
BKH 5.0 flat 42-50 DT GK FR,		1	
Mounting bracket / door frame		1	
Combustion chamber inner lining cast iron (FR/Guss)		1	



Additional options (for all smoke hood variants)			
EAS (see page7)			1971,50
Reduced price for EAS without display			-192,50
Glass ceramic coated (GKB)			123,00
Combustion chamber inner lining cast iron (FR/Guss)			585,00
Catalyst module BKH 5.0	HK000210		1132,50
Supply air connection box ø 125 mm included at EAS version	HK000135		130,00
Supply air connection box ø 150 mm	HK000136		143,00
Heat protection panel backside	HK004450		195,00
Heat protection panel backside with one side wall	HK004450-01		319,00
Heat protection panel for one side with two side walls	HK004450-02		460,00

Smoke hood variants:





+ Cast iron hood ø 200 mm		10087	1	
Front variants:				
Mounting bracket		SET213148		3315,00
Door frame, black		SET213149		3497,00
Additional option for cast iron dome				
+ Cast iron dome MAS ø 180		D004186		0,00





Cast iron dome ø 200 mm with cast iron heat exchanger rings		R015006-02	1	
Front variants:				
Mounting bracket		SET213150		3927,50
Door frame, black		SET213151		4109,50
Alternative article: connection piece eccentric instead of cast iron dome				
Connection piece eccentric ø 200 mm		S003025		-184,50
Connection piece eccentric ø 180 mm		S003024		-184,50
Additional options				
90° bend - dumper flap and cleaning ø 200 mm		S002208		295,00
90° bend - dumper flap and cleaning ø 180 mm		S002198		274,50





+ Cast iron dome ø 180 mm low		D016042	1	
Front variants:				
Mounting bracket		SET213152		3641,50
Door frame, black		SET213153		3823,50



+ Modular accumulator MAS 440 double-layered		R009042	5	
Cast iron dome MAS ø 180		R009095-01	1	
Mounting ring		10077	1	
Front variants:				
Mounting bracket		SET213154		5126,50
Door frame, black		SET213155		5308,50
Additional option MAS				
Exchange connectiong pieceø 200 mm		R009105		75,50
Exchange connectiong pieceø 160 mm		07137		75,50



+ Boiler module		W027070	1	
Front variants:				
Mounting bracket		SET213345		5425,00
Door frame, black		SET213346		5607,00
Additional option boiler module				
Conversion kit for top outlet		W027082		184,50

Energy efficiency index A +



BKH 5.0 flat 42-50 ST

Set consists of:	Art.-Nr.	No.	Price
BKH 5.0 flat 42-50 ST GK FR,		1	
Mounting frame 60 mm / door frame		1	
Chamotte inner lining set (FR)		1	



Additional options (for all smoke hood variants)			
EAS (see page7)			1971,50
Reduced price for EAS without display			-192,50
Glass ceramic coated (GKB)			123,00
Combustion chamber inner lining cast iron (FR/Guss)			585,00
Catalyst module BKH 5.0	HK000210		1132,50
Supply air connection box ø 125 mm included at EAS version	HK000135		130,00
Supply air connection box ø 150 mm	HK000136		143,00
Heat protection panel backside	HK004450		195,00
Heat protection panel backside with one side wall	HK004450-01		319,00
Heat protection panel backside with two side walls	HK004450-02		460,00

Smoke hood variants:





+ Cast iron hood ø 200 mm	10087	1	
Front variants:			
Door frame, black		SET213156	5321,50
Mounting frame, black 60 mm		SET213157	5349,50
Additional option for cast iron dome			
Cast iron dome ø 180 mm	D004186		0,00



+ Cast iron dome ø 200 mm with cast iron heat exchanger rings	R015006-02	1	
Front variants:			
Door frame, black		SET213158	5934,00
Mounting frame, black 60 mm		SET213159	5962,00
Alternative article: connection piece eccentric instead of cast iron dome			
Connection piece eccentric ø 200 mm		S003025	-184,50
Connection piece eccentric ø 180 mm	S003024		-184,50
Additional options			
90° bend - dumper flap and cleaning ø 200 mm	S002208		295,00
90° bend - dumper flap and cleaning ø 180 mm	S002198		274,50



+ Cast iron dome ø 180 mm low	D016042	1	
Front variants:			
Door frame, black		SET213160	5648,00
Mounting frame, black 60 mm		SET213161	5676,00



+ Modular accumulator MAS 440 double-layered	R009042	5	
Cast iron dome MAS ø 180	R009095-01	1	
Mounting ring	10077	1	
Front variants:			
Door frame, black	 SET213162		7133,00
Mounting frame, black 60 mm	 SET213163		7161,00
Additional option MAS			
Exchange connectiong pieceø 200 mm	R009105		75,50
Exchange connectiong pieceø 160 mm	07137		75,50



+ Boiler module	W027070	1	
Front variants:			
Door frame, black	 SET213347		7431,50
Mounting frame, black 60 mm	 SET213348		7459,50
Additional option boiler module			
Conversion kit for top outlet	W027082		184,50

Energy efficiency index A +



BKH 5.0 flat 42-66 DT

Set consists of:	Art.-Nr.	No.	Price
BKH 5.0 flat 42-66 DT GK FR,		1	
Mounting bracket / door frame		1	
Chamotte inner lining set (FR)		1	



Additional options (for all smoke hood variants)			
EAS (see page7)			1971,50
Reduced price for EAS without display			-192,50
Glass ceramic coated (GKB)			130,00
Combustion chamber inner lining cast iron (FR/Guss)			637,00
Catalyst module BKH 5.0	HK000210		1132,50
Supply air connection box ø 125 mm included at EAS version	HK000135		130,00
Supply air connection box ø 150 mm	HK000136		143,00
Heat protection panel backside	HK004450		195,00
Heat protection panel backside with one side wall	HK004450-01		319,00
Heat protection panel backside with two side walls	HK004450-02		460,00

Smoke hood variants:



+ Cast iron hood ø 200 mm	10087	1	
Front variants:			
Mounting bracket		SET213164	3575,00
Door frame, black		SET213165	3766,00
Additional option for cast iron dome			
Cast iron dome ø 180 mm	D004186		0,00





+ Cast iron dome ø 200 mm with cast iron heat exchanger rings	R015006-02	1	
Front variants:			
Mounting bracket		SET213166	4187,50
Door frame, black		SET213167	4378,50
Alternative article: connection piece eccentric instead of cast iron dome			
Connection piece eccentric ø 200 mm		S003025	-184,50
Connection piece eccentric ø 180 mm	S003024		-184,50
Additional options			
90° bend - dumper flap and cleaning ø 200 mm	S002208		295,00
90° bend - dumper flap and cleaning ø 180 mm	S002198		274,50





+ Cast iron dome ø 180 mm low	D016042	1	
Front variants:			
Mounting bracket		SET213168	3901,50
Door frame, black		SET213169	4092,50



+ Modular accumulator MAS 440 double-layered		R009042	5	
Cast iron dome MAS ø 180		R009095-01	1	
Mounting ring		10077	1	
Front variants:				
Mounting bracket		SET213170		5386,50
Door frame, black		SET213171		5577,50
Additional option MAS				
Exchange connectiong pieceø 200 mm		R009105		75,50
Exchange connectiong pieceø 160 mm		07137		75,50



+ Boiler module		W027070	1	
Front variants:				
Mounting bracket		SET213349		5685,00
Door frame, black		SET213350		5876,00
Additional option boiler module				
Conversion kit for top outlet		W027082		184,50

Energy efficiency index A +





BKH 5.0 flat 42-66 ST

Set consists of:	Art.-Nr.	No.	Price
BKH 5.0 flat 42-66 ST GK FR,		1	
Mounting frame 60 mm / door frame		1	
Chamotte inner lining set (FR)		1	



Additional options (for all smoke hood variants)			
EAS (see page 7)			1971,50
Reduced price for EAS without display			-192,50
Glass ceramic coated (GKB)			130,00
Combustion chamber inner lining cast iron (FR/Guss)			637,00
Catalyst module BKH 5.0	HK000210		1132,50
Supply air connection box ø 125 mm included at EAS version	HK000135		130,00
Supply air connection box ø 150 mm	HK000136		143,00
Heat protection panel backside	HK004450		195,00
Heat protection panel backside with one side wall	HK004450-01		319,00
Heat protection panel backside with two side walls	HK004450-02		460,00

Smoke hood variants:





+ Cast iron hood ø 200 mm	10087	1	
Front variants:			
Door frame, black		SET213172	5653,50
Mounting frame, black 60 mm		SET213173	5676,50
Additional option for cast iron dome			
Cast iron dome ø 180 mm	D004186		0,00





+ Cast iron dome ø 200 mm with cast iron heat exchanger rings	R015006-02	1	
Front variants:			
Door frame, black		SET213174	6266,00
Mounting frame, black 60 mm		SET213175	6289,00
Alternative article: connection piece eccentric instead of cast iron dome			
Connection piece eccentric ø 200 mm		S003025	-184,50
Connection piece eccentric ø 180 mm		S003024	-184,50
Additional options			
90° bend - dumper flap and cleaning ø 200 mm	S002208		295,00
90° bend - dumper flap and cleaning ø 180 mm	S002198		274,50



+ Cast iron dome ø 180 mm low	D016042	1	
Front variants:			
Door frame, black		SET213176	5980,00
Mounting frame, black 60 mm		SET213177	6003,00



+ Modular accumulator MAS 440 double-layered	R009042	5	
Cast iron dome MAS ø 180	R009095-01	1	
Mounting ring	10077	1	
Front variants:			
Door frame, black	 SET213178		7465,50
Mounting frame, black 60 mm	 SET213179		7488,00
Additional option MAS			
Exchange connectiong pieceø 200 mm	R009105		75,50
Exchange connectiong pieceø 160 mm	07137		75,50



+ Boiler module	W027070	1	
Front variants:			
Door frame, black	 SET213351		7763,50
Mounting frame, black 60 mm	 SET213352		7786,50
Additional option boiler module			
Conversion kit for top outlet	W027082		184,50

Energy efficiency index A +





BKH 5.0 flat 42-98 ST

Set consists of:	Art.-Nr.	No.	Price
BKH 5.0 flat 42-98 ST GK FR,		1	
Mounting frame 60 mm / door frame		1	
Chamotte inner lining set (FR)		1	



Additional options (for all smoke hood variants)			
EAS (see page 7)			1971,50
Reduced price for EAS without display			-192,50
Glass ceramic coated (GKB)			221,00
Combustion chamber inner lining cast iron (FR/Guss)			689,00
Catalyst module BKH 5.0	HK000210		1132,50
Supply air connection box ø 125 mm included at EAS version	HK000135		130,00
Supply air connection box ø 150 mm	HK000136		143,00

Smoke hood variants:





+ Cast iron hood ø 200 mm	10087	1	
Front variants:			
Door frame, black		SET213265	6577,50
Mounting frame, black 60 mm		SET213266	6601,50
Additional option for cast iron dome			
Cast iron dome ø 180 mm	D004186		0,00



+ Cast iron dome ø 200 mm with cast iron heat exchanger rings	R015006-04	1	
Front variants:			
Door frame, black		SET213267	7802,00
Mounting frame, black 60 mm		SET213268	7826,00
Alternative article: connection piece eccentric instead of cast iron dome			
Connection piece eccentric ø 200 mm		S003025	-184,50
Connection piece eccentric ø 180 mm		S003024	-184,50
Additional options			
90° bend - dumper flap and cleaning ø 200 mm	S002208		295,00
90° bend - dumper flap and cleaning ø 180 mm	S002198		274,50



+ Modular accumulator MAS 440 double-layered	R009042	5	
Cast iron dome MAS ø 180	R009095-01	1	
Mounting ring	10077	1	
Front variants:			
Door frame, black		SET213269	8389,00
Mounting frame, black 60 mm		SET213270	8413,00
Additional option MAS			
Exchange connection piece ø 200 mm	R009105		75,50
Exchange connection piece ø 160 mm	07137		75,50



+ Boiler module	W027070	1	
Front variants:			
Door frame, black		SET213353	8687,50
Mounting frame, black 60 mm		SET213354	8711,50
Additional option boiler module			
Conversion kit for top outlet	W027082		184,50

Energy efficiency index A +

Indications of abbreviations (see page 4)



BKH 5.0 flat 50-82 ST

Set consists of:	Art.-Nr.	No.	Price
BKH 5.0 flat 50-82 ST GK FR,		1	
Mounting frame 60 mm / door frame		1	
Chamotte inner lining set (FR)		1	

Additional options (for all smoke hood variants)			
EAS (see page 7)			1971,50
Reduced price for EAS without display			-192,50
Glass ceramic coated (GKB)			221,00
Combustion chamber inner lining cast iron (FR/Guss)			650,00
Catalyst module BKH 5.0	HK000210		1132,50
Supply air connection box ø 125 mm included at EAS version	HK000135		130,00
Supply air connection box ø 150 mm	HK000136		143,00

Smoke hood variants:



+ Cast iron hood ø 200 mm	10087	1	
Front variants:			
Door frame, black		SET213277	6572,00
Mounting frame, black 60 mm		SET213278	6591,00
Additional option for cast iron dome			
Cast iron dome ø 180 mm	D004186		0,00



+ Cast iron dome ø 200 mm with cast iron heat exchanger rings	R015006-04	1	
Alternative article: connection piece eccentric instead of cast iron dome			
Connection piece eccentric ø 200 mm		S003025	-184,50
Connection piece eccentric ø 180 mm		S003024	-184,50
Additional options			
90° bend - dumper flap and cleaning ø 200 mm	S002208		295,00
90° bend - dumper flap and cleaning ø 180 mm	S002198		274,50
Front variants:			
Door frame, black		SET213279	7797,00
Mounting frame, black 60 mm		SET213280	7815,50



+ Modular accumulator MAS 440 double-layered	R009042	5	
Cast iron dome MAS ø 180	R009095-01	1	
Mounting ring	10077	1	
Front variants:			
Door frame, black		SET213281	8383,50
Mounting frame, black 60 mm		SET213282	8402,50
Additional option MAS			
Exchange connection piece ø 200 mm	R009105		75,50
Exchange connection piece ø 160 mm	07137		75,50



+ Boiler module		W027070	1	
Front variants:				
Door frame, black		SET213355		8682,00
Mounting frame, black 60 mm		SET213356		8701,00
Additional option boiler module				
Conversion kit for top outlet		W027082		184,50

Energy efficiency index A +

Indications of abbreviations (see page4)





BKH 5.0 flat 50-98 ST

Set consists of:	Art.-Nr.	No.	Price
BKH 5.0 flat 50-98 ST GK FR,		1	
Mounting frame 60 mm / door frame		1	
Chamotte inner lining set (FR)		1	



Additional options (for all smoke hood variants)			
EAS (see page 7)			1971,50
Reduced price for EAS without display			-192,50
Glass ceramic coated (GKB)			230,00
Combustion chamber inner lining cast iron (FR/Guss)			689,00
Catalyst module BKH 5.0	HK000210		1132,50
Supply air connection box ø 125 mm included at EAS version	HK000135		130,00
Supply air connection box ø 150 mm	HK000136		143,00

Smoke hood variants:





+ Cast iron hood ø 200 mm	10087	1	
Front variants:			
Door frame, black		SET213180	6755,00
Mounting frame, black 60 mm		SET213181	6779,00
Additional option for cast iron dome			
Cast iron dome ø 180 mm	D004186		0,00



+ Cast iron dome ø 200 mm with cast iron heat exchanger rings	R015006-04	1	
Front variants:			
Door frame, black		SET213182	7979,00
Mounting frame, black 60 mm		SET213183	8003,00
Alternative article: connection piece eccentric instead of cast iron dome			
Connection piece eccentric ø 200 mm		S003025	-184,50
Connection piece eccentric ø 180 mm	S003024		-184,50
Additional options			
90° bend - dumper flap and cleaning ø 200 mm	S002208		295,00
90° bend - dumper flap and cleaning ø 180 mm	S002198		274,50



+ Modular accumulator MAS 440 double-layered	R009042	5	
Cast iron dome MAS ø 180	R009095-01	1	
Mounting ring	10077	1	
Front variants:			
Door frame, black		SET213186	8566,50
Mounting frame, black 60 mm		SET213187	8590,50
Additional option MAS			
Exchange connection piece ø 200 mm	R009105		75,50
Exchange connection piece ø 160 mm	07137		75,50



+ Boiler module	W027070	1	
Front variants:			
Door frame, black		SET213357	8864,50
Mounting frame, black 60 mm		SET213358	8889,00
Additional option boiler module			
Conversion kit for top outlet	W027082		184,50

Energy efficiency index A +

Indications of abbreviations (see page 4)

Auslaufartikel



Architektur-Kamin 38/86 lifting door

Set consists of:	Art.-Nr.	No.	Price
AK 38/86 lifting door , single glazing, outlet \varnothing 200 mm		1	
Door frame or mounting frame		1	
Chamotte lining set, bright, for AK 38/86		1	
Hot air convection top for AK 38/86		1	

Additional options			
EAS (see page 11)			2030,00
Reduced price for EAS without display			-192,50
Double glazing			416,00
Counterweights for non-self closing door	49097		60,50
Smoke pipe adapter for horizontal/vertical outlet	BSK7000-129		527,00
Exchange connection piece \varnothing 180 mm	I019448		79,50

Available variants:

Front variants:				
Door frame, black		SET205844		7424,50
Mounting frame, black, 50 mm		SET205846		7364,00
Mounting frame, black, 70 mm		SET208909		7390,50

Energy efficiency class A

Architektur-Kamin 45/101 lifting door



Auslaufartikel



Set consists of:	Art.-Nr.	No.	Price
AK 45/101 lifting door , single glazing, outlet \varnothing 250 mm		1	
Door frame or mounting frame		1	
Chamotte lining set, bright, for AK 45/101		1	
Hot air convection top for AK 45/101		1	

Additional options			
EAS (see page 11)			2030,00
Reduced price for EAS without display			-192,50
Counterweights for non-self closing door	49097		60,50
Double glazing			526,50
Smoke pipe adapter for horizontal outlet	I019490		388,50
Exchange connection piece \varnothing 180 mm	I019448		79,50
Exchange connection piece \varnothing 200 mm	I019449		79,50

Available variants:

Front variants:				
Door frame - mounting frame		SET205850		7906,50
Mounting bracket, 50 mm		SET205852		7844,00
Mounting frame, black, 70 mm		SET208912		7891,00

Energy efficiency class A

Architektur-Kamin 53/121 lifting door



Auslaufartikel



Set consists of:	Art.-Nr.	No.	Price
AK 53/121 lifting door , single glazing, outlet ø 250 mm		1	
Door frame or mounting frame		1	
Chamotte lining set, bright, for AK 53/121		1	

Additional options			
Counterweights for non-self closing door (lifting door only)	49097		60,50
Double glazing			663,00
Smoke pipe adapter for horizontal outlet	I019490		388,50
Exchange connecting piece ø 200 mm	I019449		79,50

Available variants:

Front variants:				
Door frame, black		SET205860		8666,50
Mounting frame, black, 50 mm		SET205862		8612,50
Mounting frame, black, 70 mm		SET208915		8637,00

Energy efficiency index A +

Architektur-Kamin 53/166 lifting door



Auslaufartikel



Set consists of:	Art.-Nr.	No.	Price
AK 53/166 lifting door , single glazing, outlet ø 250 mm		1	
Door frame or mounting frame		1	
Chamotte lining set, bright, for AK 53/166		1	

Additional options			
Counterweights for non-self closing door	49097		60,50
Double glazing			871,00
Smoke pipe adapter for horizontal outlet	I019490		388,50
Exchange connecting piece ø 200 mm	I019449		79,50

Available variants:

Front variants:				
Door frame, black		SET205872		9858,00
Mounting frame, black, 50 mm		SET205874		9767,00
Mounting frame, black, 70 mm		SET208919		9826,00

Energy efficiency index A +

Auslaufartikel



Stil-Kamin 51/67 side-opening door, single glazing

Set consists of:	Art.-Nr.	No.	Price
Stil-Kamin 51/67, side-opening door, single glazing, outlet ø 250 mm		1	
Door frame or mounting frame		1	
Chamotte lining kit (rill optic)		1	
hot air convection top		1	

Additional options			
EAS (see page 11)			2030,00
Reduced price for EAS without display			-192,50
Double glazing			375,50
Smoke pipe adapter for horizontal outlet	I019490		388,50
Exchange connectiong pieceø 180 mm	I019448		79,50
Exchange connectiong pieceø 200 mm	I019449		79,50

Available variants:

Front variants			
Door frame, black		SET210535	5187,50

Energy efficiency index A +

Stil-Kamin 51/67 lifting door, single glazing



Auslaufartikel



Set consists of:	Art.-Nr.	No.	Price
Stil-Kamin 51/67, lifting door, single glazing, outlet ø 250 mm		1	
Door frame or mounting frame		1	
Chamotte lining kit (rill optic)		1	
hot air convection top		1	

Additional options			
EAS (see page 11)			2030,00
Reduced price for EAS without display			-192,50
Counterweights for non-self closing door	49097		60,50
Double glazing			375,50
Smoke pipe adapter for horizontal outlet	I019490		388,50
Exchange connectiong pieceø 180 mm	I019448		79,50
Exchange connectiong pieceø 200 mm	I019449		79,50

Available variants:

Front variants:			
Door frame, black		SET210537	6297,00
Mounting frame, black, 50 mm		SET210539	6297,00
Mounting frame, black 70 mm		SET210541	6380,50

Energy efficiency index A +

Stil-Kamin 53/88 lifting door, single glazing





Set consists of:	Art.-Nr.	No.	Price
Stil-Kamin 53/88 lifting door, single glazing		1	
Door frame or mounting frame		1	
Chamotte lining set (brick plates)		1	



Additional options (for all smoke hood variants)			
EAS (see page 11)			2030,00
Reduced price for EAS without display			-192,50
Double glazing			500,50
Counterweights for non-self closing door	49097		60,50
Inner linings (smooth)	I049224		-113,50

Smoke hood variants:





Cast iron hot air hood ø 200 mm	R014022-01	1	
Front variants:			
Door frame, black	 SET211008		7310,00
Mounting frame, black, 50 mm	 SET211010		7302,00
Mounting frame, black, 70 mm	 SET211012		7340,00
Additional option for steel smoke hood vertical			
Cast iron hot air hood ø 250 mm	R014022-02		0,00
Cast iron hot air hood ø 180 mm	R014022-03		0,00



+Cast iron hood ø 200 mm	10087	1	
Front variants:			
Door frame, black	 SET209972		7090,00
Mounting frame, black, 50 mm	 SET209974		7082,50
Mounting frame, black, 70 mm	 SET209978		7120,00
Additional option for cast iron dome			
Cast iron dome ø 180 mm	D004186		0,00



+ Modular accumulator MAS 440 double-layered	R009042	5	
Cast iron dome MAS ø 180	R009095-01	1	
Mounting ring	10077	1	
Front variants:			
Door frame, black	 SET209979		8902,00
Mounting frame, black, 50 mm	 SET209981		8894,00
Mounting frame, black, 70 mm	 SET209983		8931,50
Additional option MAS			
Exchange connection piece ø 200 mm	R009105		75,50
Exchange connection piece ø 160 mm	07137		75,50

Energy efficiency index A +





Stil-Kamin 62/76 lifting door, single glazing

Set consists of:	Art.-Nr.	No.	Price
Stil-Kamin 62/76 lifting door, single glazing		1	
Door frame or mounting frame		1	
Chamotte lining set (brick plates)		1	



Additional options (for all smoke hood variants)			
EAS (see page 11)			2030,00
Reduced price for EAS without display			-192,50
Double glazing			542,00
Counterweights for non-self closing door	49097		60,50
Inner linings (smooth)	I003623		-133,00

Smoke hood variants:





Cast iron hot air hood ø 200 mm	R014022-01	1	
Front variants:			
Door frame, black	 SET210356		7431,00
Mounting frame, black, 50 mm	 SET210358		7350,00
Mounting frame, black, 70 mm	 SET210360		7420,00
Additional option for steel smoke hood vertical			
Cast iron hot air hood ø 250 mm	R014022-02		0,00
Cast iron hot air hood ø 180 mm	R014022-03		0,00



+Cast iron hood ø 200 mm	10087	1	
Front variants:			
Door frame, black	 SET209930		7211,00
Mounting frame, black, 50 mm	 SET209932		7130,50
Mounting frame, black, 70 mm	 SET209936		7200,00
Additional option for cast iron dome			
Cast iron dome ø 180 mm	D004186		0,00



+ Modular accumulator MAS 440 double-layered	R009042	5	
Cast iron dome MAS ø 180	R009095-01	1	
Mounting ring	10077	1	
Front variants:			
Door frame, black	 SET209937		9022,50
Mounting frame, black, 50 mm	 SET209939		8942,00
Mounting frame, black, 70 mm	 SET209941		9011,50
Additional option MAS			
Exchange connectiong piece ø 200 mm	R009105		75,50
Exchange connectiong piece ø 160 mm	07137		75,50

Energy efficiency index A +

Stil-Kamin 62/76 k lifting door, single glazing



Auslaufartikel



Set consists of:	Art.-Nr.	No.	Price
Stil-Kamin 62/76 k lifting door , single glazing, outlet ø 200 mm		1	
Door frame or mounting frame		1	
Chamotte lining set (brick plates)		1	

Additional options			
Double glazing			542,00
Counterweights for non-self closing door	49097		60,50
Exchange connectiong pieceø 180 mm	I058043		100,00

Available variants:

Front variants:				
Door frame, black		SET205295		6704,00
Mounting frame, black, 50 mm		SET205297		6623,50
Mounting frame, black, 70 mm		SET208902		6693,00

Energy efficiency index A +





Stil-Kamin 75/90 lifting door, single glazing

Set consists of:	Art.-Nr.	No.	Price
Stil-Kamin 75/90 lifting door, single glazing		1	
Door frame or mounting frame		1	
Chamotte lining set (brick plates)		1	



Additional options (for all smoke hood variants)			
EAS (see page 11)			2030,00
Reduced price for EAS without display			-192,50
Double glazing			695,50
Counterweights for non-self closing door	49097		60,50
Inner linings (smooth)	40987		-133,00

Smoke hood variants:





Cast iron hot air hood ø 200 mm	R014022-01	1	
Front variants:			
Door frame, black		SET211015	9711,50
Mounting frame, black, 50 mm		SET211017	9633,00
Mounting frame, black, 70 mm		SET211018	9730,00
Additional option for steel smoke hood vertical			
Cast iron hot air hood ø 250 mm	R014022-02		0,00
Cast iron hot air hood ø 180 mm	R014022-03		0,00



+ Cast iron hood ø 200 mm	10087	1	
Front variants:			
Door frame, black		SET209944	9492,00
Mounting frame, black, 50 mm		SET209946	9413,50
Mounting frame, black, 70 mm		SET209950	9510,00
Additional option for cast iron dome			
Cast iron dome ø 180 mm	D004186		0,00



+ Modular accumulator MAS 440 double-layered	R009042	5	
Cast iron dome MAS ø 180	R009095-01	1	
Mounting ring	10077	1	
Front variants:			
Door frame, black		SET209951	11303,50
Mounting frame, black, 50 mm		SET209953	11225,00
Mounting frame, black, 70 mm		SET209955	11321,50
Additional option MAS			
Exchange connectiong piece ø 200 mm	R009105		75,50
Exchange connectiong piece ø 160 mm	07137		75,50

Energy efficiency index A +

flat

Tunnel

Eck

Panorama



BKH 5.0 Tunnel 42-50 DT-DT

Set consists of:	Art.-Nr.	No.	Price
BKH 5.0 Tunnel 42-50 DT-DT GK FR,		1	
Mounting bracket / door frame		2	
Chamotte inner lining set (FR)		1	

Additional options (for all smoke hood variants)			
EAS (see page 7)			1971,50
Reduced price for EAS without display			-192,50
Glass ceramic coated (GKB)			245,50
Combustion chamber inner lining cast iron (FR/Guss)			377,00
Catalyst module BKH 5.0	HK000210		1132,50
Supply air connection box ø 125 mm included at EAS version	HK000135		130,00
Supply air connection box ø 150 mm	HK000136		143,00
Heat protection panel for one side	HK014251		158,00



Attention: Tunnel inserts can only be operated on one side, the other side is equipped with an inspection handle. With the EAS version, only one door contact switch is installed on the operating side.

Smoke hood variants:



+ Cast iron hood ø 200 mm		10087	1	
Front variants:				
Mounting bracket		SET213188		4732,00
Door frame, black		SET213189		5096,00
Additional option for cast iron dome				
Cast iron dome ø 180 mm		D004186		0,00





+ Cast iron dome ø 200 mm with cast iron heat exchanger rings		R015006-02	1	
Front variants:				
Mounting bracket		SET213190		5344,50
Door frame, black		SET213191		5708,50
Alternative article: connection piece eccentric instead of cast iron dome				
Connection piece eccentric ø 200 mm		S003025		-184,50
Connection piece eccentric ø 180 mm		S003024		-184,50
Additional options				
90° bend - dumper flap and cleaning ø 200 mm		S002208		295,00
90° bend - dumper flap and cleaning ø 180 mm		S002198		274,50





+ Cast iron dome ø 180 mm low		D016042	1	
Front variants:				
Mounting bracket		SET213192		5058,50
Door frame, black		SET213193		5422,50



+ Modular accumulator MAS 440 double-layered		R009042	5	
Cast iron dome MAS ø 180		R009095-01	1	
Mounting ring		10077	1	
Front variants:				
Mounting bracket		SET213194		6543,50
Door frame, black		SET213195		6907,50
Additional option MAS				
Exchange connectiong pieceø 200 mm		R009105		75,50
Exchange connectiong pieceø 160 mm		07137		75,50



+ Boiler module		W027070	1	
Front variants:				
Mounting bracket		SET213359		6842,00
Door frame, black		SET213360		7206,00
Additional option boiler module				
Conversion kit for top outlet		W027082		184,50

Energy efficiency index A +

BKH 5.0 Tunnel 42-50 ST-DT



Set consists of:	Art.-Nr.	No.	Price
BKH 5.0 Tunnel 42-50 ST-DT GK FR,		1	
Mounting frame 60 mm / door frame		2	
Chamotte inner lining set (FR)		1	

Additional options (for all smoke hood variants)			
EAS (see page 7)			1971,50
Reduced price for EAS without display			-192,50
Glass ceramic coated (GKB)			245,50
Combustion chamber inner lining cast iron (FR/Guss)			377,00
Catalyst module BKH 5.0	HK000210		1132,50
Supply air connection box ø 125 mm included at EAS version	HK000135		130,00
Supply air connection box ø 150 mm	HK000136		143,00
Heat protection panel for one side	HK014251		158,00
Attention: Tunnel inserts can only be operated on one side, the other side is equipped with an inspection handle. With the EAS version, only one door contact switch is installed on the operating side. With ST-DT and ST-KT, the ST side is therefore the operable side.			

Smoke hood variants:



+ Cast iron hood ø 200 mm		10087	1	
Front variants:				
Door frame, black		SET213196		7193,50
Mounting frame, black 60 mm		SET213197		7039,50
Additional option for cast iron dome				
Cast iron dome ø 180 mm		D004186		0,00





+ Cast iron dome ø 200 mm with cast iron heat exchanger rings		R015006-02	1	
Front variants:				
Door frame, black		SET213198		7806,00
Mounting frame, black 60 mm		SET213199		7652,00
Alternative article: connection piece eccentric instead of cast iron dome				
Connection piece eccentric ø 200 mm		S003025		-184,50
Connection piece eccentric ø 180 mm		S003024		-184,50
Additional options				
90° bend - dumper flap and cleaning ø 200 mm		S002208		295,00
90° bend - dumper flap and cleaning ø 180 mm		S002198		274,50



+ Cast iron dome ø 180 mm low		D016042	1	
Front variants:				
Door frame, black		SET213200		7520,00
Mounting frame, black 60 mm		SET213201		7366,00



+ Modular accumulator MAS 440 double-layered	R009042	5	
Cast iron dome MAS ø 180	R009095-01	1	
Mounting ring	10077	1	
Front variants:			
Door frame, black	 SET213202		9005,00
Mounting frame, black 60 mm	 SET213203		8851,00
Additional option MAS			
Exchange connectiong pieceø 200 mm	R009105		75,50
Exchange connectiong pieceø 160 mm	07137		75,50



+ Boiler module	W027070	1	
Front variants:			
Door frame, black	 SET213361		9303,50
Mounting frame, black 60 mm	 SET213362		9149,50
Additional option boiler module			
Conversion kit for top outlet	W027082		184,50

Energy efficiency index A +



BKH 5.0 Tunnel 42-66 DT-DT

Set consists of:	Art.-Nr.	No.	Price
BKH 5.0 Tunnel 42-66 DT-DT GK FR,		1	
Mounting bracket / door frame		2	
Chamotte inner lining set (FR)		1	

Additional options (for all smoke hood variants)			
EAS (see page 7)			1971,50
Reduced price for EAS without display			-192,50
Glass ceramic coated (GKB)			260,00
Combustion chamber inner lining cast iron (FR/Guss)			377,00
Catalyst module BKH 5.0	HK000210		1132,50
Supply air connection box ø 125 mm included at EAS version	HK000135		130,00
Supply air connection box ø 150 mm	HK000136		143,00
Heat protection panel for one side	HK014251		158,00



Attention: Tunnel inserts can only be operated on one side, the other side is equipped with an inspection handle. With the EAS version, only one door contact switch is installed on the operating side.

Smoke hood variants:



+ Cast iron hood ø 200 mm	10087	1	
Front variants:			
Mounting bracket		SET213204	5057,00
Door frame, black		SET213205	5439,00
Additional option for cast iron dome			
Cast iron dome ø 180 mm	D004186		0,00





+ Cast iron dome ø 200 mm with cast iron heat exchanger rings	R015006-02	1	
Front variants:			
Mounting bracket		SET213206	5669,50
Door frame, black		SET213207	6051,50
Alternative article: connection piece eccentric instead of cast iron dome			
Connection piece eccentric ø 200 mm		S003025	-184,50
Connection piece eccentric ø 180 mm	S003024		-184,50
Additional options			
90° bend - dumper flap and cleaning ø 200 mm	S002208		295,00
90° bend - dumper flap and cleaning ø 180 mm	S002198		274,50





+ Cast iron dome ø 180 mm low	D016042	1	
Front variants:			
Mounting bracket		SET213208	5383,50
Door frame, black		SET213209	5765,50



+ Modular accumulator MAS 440 double-layered		R009042	5	
Cast iron dome MAS ø 180		R009095-01	1	
Mounting ring		10077	1	
Front variants:				
Mounting bracket		SET213210		6868,50
Door frame, black		SET213211		7251,00
Additional option MAS				
Exchange connectiong pieceø 200 mm		R009105		75,50
Exchange connectiong pieceø 160 mm		07137		75,50



+ Boiler module		W027070	1	
Front variants:				
Mounting bracket		SET213363		7167,00
Door frame, black		SET213364		7549,00
Additional option boiler module				
Conversion kit for top outlet		W027082		184,50

Energy efficiency index A +



BKH 5.0 Tunnel 42-66 ST-DT

Set consists of:	Art.-Nr.	No.	Price
BKH 5.0 Tunnel 42-66 ST-DT GK FR,		1	
Mounting frame 60 mm / door frame		2	
Chamotte inner lining set (FR)		1	



Additional options (for all smoke hood variants)			
EAS (see page7)			1971,50
Reduced price for EAS without display			-192,50
Glass ceramic coated (GKB)			260,00
Combustion chamber inner lining cast iron (FR/Guss)			377,00
Catalyst module BKH 5.0	HK000210		1132,50
Supply air connection box ø 125 mm included at EAS version	HK000135		130,00
Supply air connection box ø 150 mm	HK000136		143,00
Heat protection panel for one side	HK014251		158,00
Attention: Tunnel inserts can only be operated on one side, the other side is equipped with an inspection handle. With the EAS version, only one door contact switch is installed on the operating side. With ST-DT and ST-KT, the ST side is therefore the operable side.			

Smoke hood variants:





+ Cast iron hood ø 200 mm	10087	1	
Front variants:			
Door frame, black		SET213212	7418,00
Mounting frame, black 60 mm		SET213213	7249,50
Additional option for cast iron dome			
Cast iron dome ø 180 mm	D004186		0,00





+ Cast iron dome ø 200 mm with cast iron heat exchanger rings	R015006-02	1	
Front variants:			
Door frame, black		SET213214	8030,00
Mounting frame, black 60 mm		SET213215	7862,00
Alternative article: connection piece eccentric instead of cast iron dome			
Connection piece eccentric ø 200 mm		S003025	-184,50
Connection piece eccentric ø 180 mm		S003024	-184,50
Additional options			
90° bend - dumper flap and cleaning ø 200 mm	S002208		295,00
90° bend - dumper flap and cleaning ø 180 mm	S002198		274,50



+ Cast iron dome ø 180 mm low	D016042	1	
Front variants:			
Door frame, black		SET213216	7744,00
Mounting frame, black 60 mm		SET213217	7576,00



+ Modular accumulator MAS 440 double-layered	R009042	5	
Cast iron dome MAS ø 180	R009095-01	1	
Mounting ring	10077	1	
Front variants:			
Door frame, black	 SET213218		9229,50
Mounting frame, black 60 mm	 SET213219		9061,00
Additional option MAS			
Exchange connectiong pieceø 200 mm	R009105		75,50
Exchange connectiong pieceø 160 mm	07137		75,50



+ Boiler module	W027070	1	
Front variants:			
Door frame, black	 SET213365		9527,50
Mounting frame, black 60 mm	 SET213366		9359,50
Additional option boiler module			
Conversion kit for top outlet	W027082		184,50

Energy efficiency index A +



BKH 5.0 Tunnel 42-98 ST-KT

Set consists of:	Art.-Nr.	No.	Price
BKH 5.0 Tunnel 42-98 ST-KT GK FR,		1	
Mounting frame 60 mm / door frame		2	
Chamotte inner lining set (FR)		1	

Additional options (for all smoke hood variants)			
EAS (see page 7)			1971,50
Reduced price for EAS without display			-192,50
Glass ceramic coated (GKB)			442,00
Combustion chamber inner lining cast iron (FR/Guss)			416,00
Catalyst module BKH 5.0	HK000210		1132,50
Supply air connection box ø 125 mm included at EAS version	HK000135		130,00
Supply air connection box ø 150 mm	HK000136		143,00

Attention: Tunnel inserts can only be operated on one side, the other side is equipped with an inspection handle. With the EAS version, only one door contact switch is installed on the operating side.
With ST-DT and ST-KT, the ST side is therefore the operable side.

Smoke hood variants:



+ Cast iron hood ø 200 mm		10087	1	
Front variants:				
Door frame, black		SET213271		8929,50
Mounting frame, black 60 mm		SET213272		8978,00
Additional option for cast iron dome				
Cast iron dome ø 180 mm		D004186		0,00



+ Cast iron dome ø 200 mm with cast iron heat exchanger rings		R015006-04	1	
Front variants:				
Door frame, black		SET213273		10154,50
Mounting frame, black 60 mm		SET213274		10202,50
Alternative article: connection piece eccentric instead of cast iron dome				
Connection piece eccentric ø 200 mm		S003025		-184,50
Connection piece eccentric ø 180 mm		S003024		-184,50
Additional options				
90° bend - dumper flap and cleaning ø 200 mm		S002208		295,00
90° bend - dumper flap and cleaning ø 180 mm		S002198		274,50



+ Modular accumulator MAS 440 double-layered		R009042	5	
Cast iron dome MAS ø 180		R009095-01	1	
Mounting ring		10077	1	
Front variants:				
Door frame, black		SET213275		10741,50
Mounting frame, black 60 mm		SET213276		10789,50
Additional option MAS				
Exchange connectiong pieceø 200 mm		R009105		75,50
Exchange connectiong pieceø 160 mm		07137		75,50



+ Boiler module	W027070	1	
Front variants:			
Door frame, black		SET213367	11039,50
Mounting frame, black 60 mm		SET213368	11087,50
Additional option boiler module			
Conversion kit for top outlet	W027082		184,50

Energy efficiency index A +

flat

Tunnel

Eck

Panorama



BKH 5.0 Tunnel 50-82 ST-KT

Set consists of:	Art.-Nr.	No.	Price
BKH 5.0 Tunnel 50-82 ST-KT GK FR,		1	
Mounting frame 60 mm / door frame		2	
Chamotte inner lining set (FR)		1	

Additional options (for all smoke hood variants)			
EAS (see page 7)			1971,50
Reduced price for EAS without display			-192,50
Glass ceramic coated (GKB)			442,00
Combustion chamber inner lining cast iron (FR/Guss)			416,00
Catalyst module BKH 5.0	HK000210		1132,50
Supply air connection box ø 125 mm included at EAS version	HK000135		130,00
Supply air connection box ø 150 mm	HK000136		143,00
Attention: Tunnel inserts can only be operated on one side, the other side is equipped with an inspection handle. With the EAS version, only one door contact switch is installed on the operating side. With ST-DT and ST-KT, the ST side is therefore the operable side.			

Smoke hood variants:



+ Cast iron hood ø 200 mm		10087	1	
Front variants:				
Door frame, black		SET213283		8919,50
Mounting frame, black 60 mm		SET213284		8957,00
Additional option for cast iron dome				
Cast iron dome ø 180 mm		D004186		0,00



+ Cast iron dome ø 200 mm with cast iron heat exchanger rings		R015006-04	1	
Front variants:				
Door frame, black		SET213285		10144,00
Mounting frame, black 60 mm		SET213286		10181,50
Alternative article: connection piece eccentric instead of cast iron dome				
Connection piece eccentric ø 200 mm		S003025		-184,50
Connection piece eccentric ø 180 mm		S003024		-184,50
Additional options				
90° bend - dumper flap and cleaning ø 200 mm		S002208		295,00
90° bend - dumper flap and cleaning ø 180 mm		S002198		274,50



+ Modular accumulator MAS 440 double-layered		R009042	5	
Cast iron dome MAS ø 180		R009095-01	1	
Mounting ring		10077	1	
Front variants:				
Door frame, black		SET213287		10731,00
Mounting frame, black 60 mm		SET213288		10768,50
Additional option MAS				
Exchange connectiong piece ø 200 mm		R009105		75,50
Exchange connectiong piece ø 160 mm		07137		75,50



+ Boiler module	W027070	1	
Front variants:			
Door frame, black		SET213369	11029,00
Mounting frame, black 60 mm		SET213370	11067,00
Additional option boiler module			
Conversion kit for top outlet	W027082		184,50

Energy efficiency index A +

flat

Tunnel

Eck

Panorama



BKH 5.0 Tunnel 50-98 ST-KT

Set consists of:	Art.-Nr.	No.	Price
BKH 5.0 Tunnel 50-98 ST-KT GK FR,		1	
Mounting frame 60 mm / door frame		2	
Chamotte inner lining set (FR)		1	

Additional options (for all smoke hood variants)			
EAS (see page 7)			1971,50
Reduced price for EAS without display			-192,50
Glass ceramic coated (GKB)			460,00
Combustion chamber inner lining cast iron (FR/Guss)			416,00
Catalyst module BKH 5.0	HK000210		1132,50
Supply air connection box ø 125 mm included at EAS version	HK000135		130,00
Supply air connection box ø 150 mm	HK000136		143,00

Attention: Tunnel inserts can only be operated on one side, the other side is equipped with an inspection handle. With the EAS version, only one door contact switch is installed on the operating side.
With ST-DT and ST-KT, the ST side is therefore the operable side.

Smoke hood variants:



+ Cast iron hood ø 200 mm		10087	1	
Front variants:				
Door frame, black		SET213220		9102,50
Mounting frame, black 60 mm		SET213221		9150,50
Additional option for cast iron dome				
Cast iron dome ø 180 mm		D004186		0,00



+ Cast iron dome ø 200 mm with cast iron heat exchanger rings		R015006-04	1	
Front variants:				
Door frame, black		SET213222		10326,50
Mounting frame, black 60 mm		SET213223		10374,50
Alternative article: connection piece eccentric instead of cast iron dome				
Connection piece eccentric ø 200 mm		S003025		-184,50
Connection piece eccentric ø 180 mm		S003024		-184,50
Additional options				
90° bend - dumper flap and cleaning ø 200 mm		S002208		295,00
90° bend - dumper flap and cleaning ø 180 mm		S002198		274,50



+ Modular accumulator MAS 440 double-layered		R009042	5	
Cast iron dome MAS ø 180		R009095-01	1	
Mounting ring		10077	1	
Front variants:				
Door frame, black		SET213226		10914,00
Mounting frame, black 60 mm		SET213227		10962,50
Additional option MAS				
Exchange connection piece ø 200 mm		R009105		75,50
Exchange connection piece ø 160 mm		07137		75,50



+ Boiler module		W027070	1	
Front variants:				
Door frame, black		SET213371		11212,50
Mounting frame, black 60 mm		SET213372		11260,50
Additional option boiler module				
Conversion kit for top outlet		W027082		184,50

Energy efficiency index A +

flat

Tunnel

Eck

Panorama

Auslaufartikel





Architektur-Kamin Tunnel 38/86 lifting/tilting door

Set consists of:	Art.-Nr.	No.	Price
AK Tunnel/double face 38/86, lifting/tilting door, single glazing, outlet ø 200 mm		1	
Door frame or mounting frame		2	
Chamotte lining set, bright, for AK Tunnel/double face 38/86		1	
Hot air convection top AK Tunnel 38/86		1	

Additional options

EAS (see page 11)			2030,00
Reduced price for EAS without display			-192,50
Counterweights for non-self closing door (only one side possible)	49097		60,50
Double glazing (also one side only available on request)			832,00
Smoke pipe adapter for horizontal/vertical outlet	BSK7000-129		527,00
Exchange connecting piece ø 180 mm	I019448		79,50
Lifting doors on both sides available upon request			

Available variants:

Front variants:			
Door frame, black		SET205887	10270,50
Mounting frame, black, 50 mm		SET205889	10150,00
Mounting frame, black, 70 mm		SET208910	10203,00

Energy efficiency class A



Architektur-Kamin Tunnel 45/101 lifting/tilting door



Set consists of:	Art.-Nr.	No.	Price
AK Tunnel/double face 45/101, lifting/tilting door, single glazing, outlet ø 250 mm		1	
Door frame or mounting frame		2	
Chamotte lining set, bright, for AK Tunnel/double face 45/101		1	
Hot air convection top AK Tunnel 45/101		1	

Additional options			
EAS (see page 11)			2030,00
Reduced price for EAS without display			-192,50
Counterweights for non-self closing door (only one side possible)	49097		60,50
Double glazing (also one side only available on request)			1053,00
Smoke pipe adapter for horizontal outlet	I019490		388,50
Exchange connectiong pieceø 180 mm	I019448		79,50
Exchange connectiong pieceø 200 mm	I019449		79,50
Lifting doors on both sides available upon request			

Available variants:

Front variants:			
Door frame, black		SET205899	11012,50
Mounting frame, black, 50 mm		SET205901	10887,50
Mounting frame, black, 70 mm		SET208913	10981,00

Energy efficiency class A

Auslaufartikel



Architektur-Kamin Tunnel 53/121 lifting/tilting door

Set consists of:	Art.-Nr.	No.	Price
AK Tunnel/double face 53/121, lifting/tilting door, single glazing, outlet ø 250 mm		1	
Door frame or mounting frame		2	
Chamotte lining set, bright, for AK Tunnel/double face 53/121		1	

Additional options

Counterweights for non-self closing door (only one side possible)	49097		60,50
Double glazing (also one side only available on request)			1326,00
Smoke pipe adapter for horizontal outlet	I019490		388,50
Exchange connectiong piece ø 200 mm	I019449		79,50

Lifting doors on both sides available upon request

Available variants:

Front variants:			
Door frame, black		SET205911	11886,00
Mounting frame, black, 50 mm		SET205913	11778,00
Mounting frame, black, 70 mm		SET208916	11827,50

Energy efficiency index A +

Architektur-Kamin Tunnel 53/166 lifting/tilting door

Auslaufartikel



Set consists of:	Art.-Nr.	No.	Price
AK Tunnel/double face 53/166, lifting/tilting door, single glazing, outlet ø 250 mm		1	
Door frame or mounting frame		2	
Chamotte lining set, bright, for AK Tunnel/double face 53/166		1	

Additional options

Counterweights for non-self closing door (only one side possible)	49097		60,50
Double glazing (also one side only available on request)			1742,00
Smoke pipe adapter for horizontal outlet	I019490		388,50
Exchange connectiong piece ø 200 mm	I019449		79,50

Lifting doors on both sides available upon request

Available variants:

Front variants:			
Door frame, black		SET205935	13574,00
Mounting frame, black, 50 mm		SET205937	13392,00
Mounting frame, black, 70 mm		SET208920	13510,50

Energy efficiency index A +

Stil-Kamin Tunnel 51/67 lifting door/side opening door



Auslaufartikel



Set consists of:	Art.-Nr.	No.	Price
Stil-KaminTunnel 51/67, lifting door/side opening door, single glazing, outlet ø 250 mm		1	
Door frame or mounting frame (DT doors with door frames by default)		2	
Grooved chamotte lining		1	
hot air convection top		1	

Additional options			
EAS (see page 11)			2218,50
Reduced price for EAS without display			-192,50
Counterweights for non-self closing door	49097		60,50
Double glazing (also one side only available on request)			751,50
Smoke pipe adapter for horizontal outlet	I019490		388,50
Exchange connectiong pieceø 180 mm	I019448		79,50
Exchange connectiong pieceø 200 mm	I019449		79,50
Revision handle	02426		169,00
Lifting doors on both sides available upon request			

Available variants:

Front variants:			
Door frame, black		SET210546	9583,00
Door frame, black DT Mounting frame, black ST 50 mm		SET210548	9583,00
Door frame, black DT Mounting frame, black ST 70 mm		SET210550	9666,00

Energy efficiency index A +





Stil-KaminTunnel 53/88 lifting/tilting door

Set consists of:	Art.-Nr.	No.	Price
Stil-KaminTunnel 53/88, lifting/tilting door, single glazing, outlet ø 250 mm		1	
Door frame or mounting frame		2	
Inner lining set for 53/88		1	

Additional options			
Counterweights for non-self closing door (lifting door only)	49097		60,50
Double glazing (also one side only available on request)			1001,00
Spare connecting piece ø 180 mm	I019448		79,50
Exchange connecting piece ø 200 mm	I019449		79,50
Lifting doors on both sides available upon request			

Available variants:

Front variants:				
Door frame, black		SET207104		10188,00
Mounting frame, black, 50 mm		SET207106		10172,50
Mounting frame, black, 70 mm		SET208907		10248,00

Energy efficiency index A +



Stil-KaminTunnel 62/76 lifting/tilting door



Set consists of:	Art.-Nr.	No.	Price
Stil-KaminTunnel 62/76, lifting/tilting door, single glazing, outlet ø 250 mm		1	
Door frame or mounting frame		2	
Inner lining set for 62/76		1	

Additional options			
Counterweights for non-self closing door (lifting door only)	49097		60,50
Double glazing (also one side only available on request)			1084,00
Spare connecting piece ø 180 mm	I019448		79,50
Exchange connecting piece ø 200 mm	I019449		79,50
Lifting doors on both sides available upon request			

Available variants:

Front variants:				
Door frame, black		SET205826		10500,00
Mounting frame, black, 50 mm		SET205828		10339,00
Mounting frame, black, 70 mm		SET208901		10478,00

Energy efficiency index A +



Stil-KaminTunnel 75/90 lifting/tilting door



Set consists of:	Art.-Nr.	No.	Price
Stil-KaminTunnel 75/90, lifting/tilting door, single glazing, outlet ø 250 mm		1	
Door frame or mounting frame		2	
Inner lining set for 75/90		1	

Additional options			
Counterweights for non-self closing door (lifting door only)	49097		60,50
Double glazing (also one side only available on request)			1391,00
Spare connecting piece ø 180 mm	I019448		79,50
Exchange connectiong pieceø 200 mm	I019449		79,50
Lifting doors on both sides available upon request			

Available variants:

Front variants:			
Door frame, black		SET205838	11888,00
Mounting frame, black, 50 mm		SET205840	11730,50
Mounting frame, black, 70 mm		SET208904	11924,50

Energy efficiency index A +





BKH 5.0 Eck 42-66-42 DTL

Set consists of:	Art.-Nr.	No.	Price
BKH 5.0 Eck 42-66-42 DTL GK FR,		1	
Mounting bracket / Door frame		1	
Chamotte inner lining set (FR)		1	



Additional options (for all smoke hood variants)			
EAS (see page11)			1971,50
Reduced price for EAS without display			-192,50
Glass ceramic coated (GKB)			325,00
Combustion chamber inner lining cast iron (FR/Guss)			429,00
Catalyst module BKH 5.0	HK000210		1132,50
Supply air connection box ø 125 mm included at EAS version	HK000135		130,00
Supply air connection box ø 150 mm	HK000136		143,00
Heat protection panel with one side wall	HK021450		351,00

Smoke hood variants:





+ Cast iron hood ø 200 mm		10087	1	
Front variants:				
Mounting bracket		SET213289		4537,00
Door frame, black		SET213290		4829,50
Additional option for cast iron dome				
Cast iron dome ø 180 mm		D004186		0,00



+ Cast iron dome ø 200 mm with cast iron heat exchanger rings		R015006-02	1	
Front variants:				
Mounting bracket		SET213291		5149,50
Door frame, black		SET213292		5442,00
Alternative article: connection piece eccentric instead of cast iron dome				
Connection piece eccentric ø 200 mm		S003025		-184,50
Connection piece eccentric ø 180 mm		S003024		-184,50
Additional options				
90° bend - dumper flap and cleaning ø 200 mm		S002208		295,00
90° bend - dumper flap and cleaning ø 180 mm		S002198		274,50



+ Cast iron dome ø 180 mm low		D016042	1	
Front variants:				
Mounting bracket		SET213293		4863,50
Door frame, black		SET213294		5156,00



+ Modular accumulator MAS 440 double-layered	R009042	5	
Cast iron dome MAS ø 180	R009095-01	1	
Mounting ring	10077	1	
Front variants:			
Mounting bracket	 SET213295		6348,50
Door frame, black	 SET213296		6641,00
Additional option MAS			
Exchange connectiong pieceø 200 mm	R009105		75,50
Exchange connectiong pieceø 160 mm	07137		75,50



+ Boiler module	W027070	1	
Front variants:			
Mounting bracket	 SET213373		6647,00
Door frame, black	 SET213374		6939,50
Additional option boiler module			
Conversion kit for top outlet	W027082		184,50

Energy efficiency index A +





BKH 5.0 Eck 42-66-42 DTR

Set consists of:	Art.-Nr.	No.	Price
BKH 5.0 Eck 42-66-42 DTR GK FR,		1	
Mounting bracket / Door frame		1	
Chamotte inner lining set (FR)		1	



Additional options (for all smoke hood variants)			
EAS (see page11)			1971,50
Reduced price for EAS without display			-192,50
Glass ceramic coated (GKB)			325,00
Combustion chamber inner lining cast iron (FR/Guss)			429,00
Catalyst module BKH 5.0	HK000210		1132,50
Supply air connection box ø 125 mm included at EAS version	HK000135		130,00
Supply air connection box ø 150 mm	HK000136		143,00
Heat protection panel with one side wall	HK021450		351,00

Smoke hood variants:





+ Cast iron hood ø 200 mm		10087	1	
Front variants:				
Mounting bracket		SET213297		4537,00
Door frame, black		SET213298		4829,50
Additional option for cast iron dome				
Cast iron dome ø 180 mm		D004186		0,00



+ Cast iron dome ø 200 mm with cast iron heat exchanger rings		R015006-02	1	
Front variants:				
Mounting bracket		SET213299		5149,50
Door frame, black		SET213300		5442,00
Alternative article: connection piece eccentric instead of cast iron dome				
Connection piece eccentric ø 200 mm		S003025		-184,50
Connection piece eccentric ø 180 mm		S003024		-184,50
Additional options				
90° bend - dumper flap and cleaning ø 200 mm		S002208		295,00
90° bend - dumper flap and cleaning ø 180 mm		S002198		274,50





+ Cast iron dome ø 180 mm low		D016042	1	
Front variants:				
Mounting bracket		SET213301		4863,50
Door frame, black		SET213302		5156,00



+ Modular accumulator MAS 440 double-layered	R009042	5	
Cast iron dome MAS ø 180	R009095-01	1	
Mounting ring	10077	1	
Front variants:			
Mounting bracket	 SET213303		6348,50
Door frame, black	 SET213304		6641,00
Additional option MAS			
Exchange connectiong pieceø 200 mm	R009105		75,50
Exchange connectiong pieceø 160 mm	07137		75,50



+ Boiler module	W027070	1	
Front variants:			
Mounting bracket	 SET213375		6647,00
Door frame, black	 SET213376		6939,50
Additional option boiler module			
Conversion kit for top outlet	W027082		184,50

Energy efficiency index A +



BKH 5.0 Eck 42-66-42 STL

Set consists of:	Art.-Nr.	No.	Price
BKH 5.0 Eck 42-66-42 STL GK FR,		1	
Mounting frame 60 mm		1	
Chamotte inner lining set (FR)		1	



Additional options (for all smoke hood variants)			
EAS (see page11)			1971,50
Reduced price for EAS without display			-192,50
Glass ceramic coated (GKB)			325,00
Combustion chamber inner lining cast iron (FR/Guss)			429,00
Catalyst module BKH 5.0	HK000210		1132,50
Supply air connection box ø 125 mm included at EAS version	HK000135		130,00
Supply air connection box ø 150 mm	HK000136		143,00
Heat protection panel with one side wall	HK021450		351,00

Smoke hood variants:



+ Cast iron hood ø 200 mm	10087	1	
Front variants:			
Mounting frame, black 60 mm	 SET213305		6357,00
Additional option for cast iron dome			
Cast iron dome ø 180 mm	D004186		0,00



+ Cast iron dome ø 200 mm with cast iron heat exchanger rings	R015006-02	1	
Front variants:			
Mounting frame, black 60 mm	 SET213306		6969,50
Alternative article: connection piece eccentric instead of cast iron dome			
Connection piece eccentric ø 200 mm	 S003025		-184,50
Connection piece eccentric ø 180 mm	S003024		-184,50
Additional options			
90° bend - dumper flap and cleaning ø 200 mm	S002208		295,00
90° bend - dumper flap and cleaning ø 180 mm	S002198		274,50



+ Modular accumulator MAS 440 double-layered	R009042	5	
Cast iron dome MAS ø 180	R009095-01	1	
Mounting ring	10077	1	
Front variants:			
Mounting frame, black 60 mm	 SET213307		8168,50
Additional option MAS			
Exchange connectiong pieceø 200 mm	R009105		75,50
Exchange connectiong pieceø 160 mm	07137		75,50



+ Boiler module	W027070	1	
Front variants:			
Mounting frame, black 60 mm	 SET213377		8467,00
Additional option boiler module			
Conversion kit for top outlet	W027082		184,50

Energy efficiency index A +

BKH 5.0 Eck 42-66-42 STR



Set consists of:	Art.-Nr.	No.	Price
BKH 5.0 Eck 42-66-42 STR GK FR,		1	
Mounting frame 60 mm		1	
Chamotte inner lining set (FR)		1	



Additional options (for all smoke hood variants)			
EAS (see page11)			1971,50
Reduced price for EAS without display			-192,50
Glass ceramic coated (GKB)			325,00
Combustion chamber inner lining cast iron (FR/Guss)			429,00
Catalyst module BKH 5.0	HK000210		1132,50
Supply air connection box ø 125 mm included at EAS version	HK000135		130,00
Supply air connection box ø 150 mm	HK000136		143,00
Heat protection panel with one side wall	HK021450		351,00

Smoke hood variants:



+ Cast iron hood ø 200 mm	10087	1	
Front variants:			
Mounting frame, black 60 mm	 SET213308		6357,00
Additional option for cast iron dome			
Cast iron dome ø 180 mm	D004186		0,00



+ Cast iron dome ø 200 mm with cast iron heat exchanger rings	R015006-02	1	
Front variants:			
Mounting frame, black 60 mm	 SET213309		6969,50
Alternative article: connection piece eccentric instead of cast iron dome			
Connection piece eccentric ø 200 mm	 S003025		-184,50
Connection piece eccentric ø 180 mm	S003024		-184,50
Additional options			
90° bend - dumper flap and cleaning ø 200 mm	S002208		295,00
90° bend - dumper flap and cleaning ø 180 mm	S002198		274,50



+ Modular accumulator MAS 440 double-layered	R009042	5	
Cast iron dome MAS ø 180	R009095-01	1	
Mounting ring	10077	1	
Front variants:			
Mounting frame, black 60 mm	 SET213310		8168,50
Additional option MAS			
Exchange connection piece ø 200 mm	R009105		75,50
Exchange connection piece ø 160 mm	07137		75,50



+ Boiler module	W027070	1	
Front variants:			
Mounting frame, black 60 mm	 SET213378		8467,00
Additional option boiler module			
Conversion kit for top outlet	W027082		184,50

Energy efficiency index A +



BKH 5.0 Eck 42-98-42 STL

Set consists of:	Art.-Nr.	No.	Price
BKH 5.0 Eck 42-98-42 STL GK FR,		1	
Mounting frame 60 mm		1	
Chamotte inner lining set (FR)		1	



Additional options (for all smoke hood variants)			
EAS (see page11)			1971,50
Reduced price for EAS without display			-192,50
Glass ceramic coated (GKB)			416,00
Combustion chamber inner lining cast iron (FR/Guss)			468,00
Catalyst module BKH 5.0	HK000210		1132,50
Supply air connection box ø 125 mm included at EAS version	HK000135		130,00
Supply air connection box ø 150 mm	HK000136		143,00

Smoke hood variants:



+ Cast iron hood ø 200 mm	10087	1	
Front variants:			
Mounting frame, black 60 mm	 SET213311		7111,00
Additional option for cast iron dome			
Cast iron dome ø 180 mm	D004186		0,00



+ Cast iron dome ø 200 mm with cast iron heat exchanger rings	R015006-04	1	
Front variants:			
Mounting frame, black 60 mm	 SET213312		8335,00
Alternative article: connection piece eccentric instead of cast iron dome			
Connection piece eccentric ø 200 mm	 S003025		-184,50
Connection piece eccentric ø 180 mm	S003024		-184,50
Additional options			
90° bend - dumper flap and cleaning ø 200 mm	S002208		295,00
90° bend - dumper flap and cleaning ø 180 mm	S002198		274,50



+ Modular accumulator MAS 440 double-layered	R009042	5	
Cast iron dome MAS ø 180	R009095-01	1	
Mounting ring	10077	1	
Front variants:			
Mounting frame, black 60 mm	 SET213313		8922,50
Additional option MAS			
Exchange connectiong pieceø 200 mm	R009105		75,50
Exchange connectiong pieceø 160 mm	07137		75,50



+ Boiler module	W027070	1	
Front variants:			
Mounting frame, black	 SET213379		9221,00
Additional option boiler module			
Conversion kit for top outlet	W027082		184,50

Energy efficiency index A +

BKH 5.0 Eck 42-98-42 STR



Set consists of:	Art.-Nr.	No.	Price
BKH 5.0 Eck 42-98-42 STR GK FR,		1	
Mounting frame 60 mm		1	
Chamotte inner lining set (FR)		1	



Additional options (for all smoke hood variants)			
EAS (see page11)			1971,50
Reduced price for EAS without display			-192,50
Glass ceramic coated (GKB)			416,00
Combustion chamber inner lining cast iron (FR/Guss)			468,00
Catalyst module BKH 5.0	HK000210		1132,50
Supply air connection box ø 125 mm included at EAS version	HK000135		130,00
Supply air connection box ø 150 mm	HK000136		143,00

Smoke hood variants:



+ Cast iron hood ø 200 mm	10087	1	
Front variants:			
Mounting frame, black 60 mm	 SET213314		7111,00
Additional option for cast iron dome			
Cast iron dome ø 180 mm	D004186		0,00



+ Cast iron dome ø 200 mm with cast iron heat exchanger rings	R015006-04	1	
Front variants:			
Mounting frame, black 60 mm	 SET213315		8335,00
Alternative article: connection piece eccentric instead of cast iron dome			
Connection piece eccentric ø 200 mm	 S003025		-184,50
Connection piece eccentric ø 180 mm	S003024		-184,50
Additional options			
90° bend - dumper flap and cleaning ø 200 mm	S002208		295,00
90° bend - dumper flap and cleaning ø 180 mm	S002198		274,50



+ Modular accumulator MAS 440 double-layered	R009042	5	
Cast iron dome MAS ø 180	R009095-01	1	
Mounting ring	10077	1	
Front variants:			
Mounting frame, black 60 mm	 SET213316		8922,50
Additional option MAS			
Exchange connection piece ø 200 mm	R009105		75,50
Exchange connection piece ø 160 mm	07137		75,50



+ Boiler module	W027070	1	
Front variants:			
Mounting frame, black 60 mm	 SET213380		9221,00
Additional option boiler module			
Conversion kit for top outlet	W027082		184,50

Energy efficiency index A +



BKH 5.0 Eck 50-82-42 STL

Set consists of:	Art.-Nr.	No.	Price
BKH 5.0 Eck 50-82-42 STL GK FR,		1	
Mounting frame 60 mm		1	
Chamotte inner lining set (FR)		1	



Additional options (for all smoke hood variants)			
EAS (see page11)			1971,50
Reduced price for EAS without display			-192,50
Glass ceramic coated (GKB)			455,00
Combustion chamber inner lining cast iron (FR/Guss)			442,00
Catalyst module BKH 5.0	HK000210		1132,50
Supply air connection box ø 125 mm included at EAS version	HK000135		130,00
Supply air connection box ø 150 mm	HK000136		143,00

Smoke hood variants:



+ Cast iron hood ø 200 mm	10087	1	
Front variants:			
Mounting frame, black 60 mm	 SET213317		6747,00
Additional option for cast iron dome			
Cast iron dome ø 180 mm	D004186		0,00



+ Cast iron dome ø 200 mm with cast iron heat exchanger rings	R015006-04	1	
Front variants:			
Mounting frame, black 60 mm	 SET213318		7971,00
Alternative article: connection piece eccentric instead of cast iron dome			
Connection piece eccentric ø 200 mm	 S003025		-184,50
Connection piece eccentric ø 180 mm	S003024		-184,50
Additional options			
90° bend - dumper flap and cleaning ø 200 mm	S002208		295,00
90° bend - dumper flap and cleaning ø 180 mm	S002198		274,50



+ Modular accumulator MAS 440 double-layered	R009042	5	
Cast iron dome MAS ø 180	R009095-01	1	
Mounting ring	10077	1	
Front variants:			
Mounting frame, black 60 mm	 SET213319		8558,50
Additional option MAS			
Exchange connectiong pieceø 200 mm	R009105		75,50
Exchange connectiong pieceø 160 mm	07137		75,50



+ Boiler module	W027070	1	
Front variants:			
Mounting frame, black 60 mm	 SET213381		8857,00
Additional option boiler module			
Conversion kit for top outlet	W027082		184,50

Energy efficiency index A +

BKH 5.0 Eck 50-82-42 STR



Set consists of:	Art.-Nr.	No.	Price
BKH 5.0 Eck 50-82-42 STR GK FR,		1	
Mounting frame 60 mm		1	
Chamotte inner lining set (FR)		1	



Additional options (for all smoke hood variants)			
EAS (see page11)			1971,50
Reduced price for EAS without display			-192,50
Glass ceramic coated (GKB)			455,00
Combustion chamber inner lining cast iron (FR/Guss)			442,00
Catalyst module BKH 5.0	HK000210		1132,50
Supply air connection box ø 125 mm included at EAS version	HK000135		130,00
Supply air connection box ø 150 mm	HK00036		143,00

Smoke hood variants:



+ Cast iron hood ø 200 mm	10087	1	
Front variants:			
Mounting frame, black 60 mm	 SET213320		6747,00
Additional option for cast iron dome			
Cast iron dome ø 180 mm	D004186		0,00



+ Cast iron dome ø 200 mm with cast iron heat exchanger rings	R015006-04	1	
Front variants:			
Mounting frame, black 60 mm	 SET213321		7971,00
Alternative article: connection piece eccentric instead of cast iron dome			
Connection piece eccentric ø 200 mm	 S003025		-184,50
Connection piece eccentric ø 180 mm	S003024		-184,50
Additional options			
90° bend - dumper flap and cleaning ø 200 mm	S002208		295,00
90° bend - dumper flap and cleaning ø 180 mm	S002198		274,50



+ Modular accumulator MAS 440 double-layered	R009042	5	
Cast iron dome MAS ø 180	R009095-01	1	
Mounting ring	10077	1	
Front variants:			
Mounting frame, black 60 mm	 SET213322		8558,50
Additional option MAS			
Exchange connection piece ø 200 mm	R009105		75,50
Exchange connection piece ø 160 mm	07137		75,50



+ Boiler module	W027070	1	
Front variants:			
Mounting frame, black 60 mm	 SET213382		8857,00
Additional option boiler module			
Conversion kit for top outlet	W027082		184,50

Energy efficiency index A +

Auslaufartikel



Eck-Kamin 42/42/42 side-opening door

Set consists of:	Art.-Nr.	No.	Price
Eck-Kamin 42/42/42 side-opening door, two-piece ceramic glass		1	
Door frame		1	
Chamotte lining set, Eck-Kamin 42/42/42		1	

Additional options (for all smoke hood variants)			
EAS (see page 11)			2030,00
Reduced price for EAS without display			-192,50
Chamotte lining, anthracite	I064043-02		273,00

Smoke hood variants:



Cast iron hot air hood ø 200 mm	R014022-01	1	
Front variants:			
Door frame, black	 SET210472		4736,00
Additional option for cast iron hot air hood			
Cast iron hot air hood ø 250 mm	R014022-02		0,00
Cast iron hot air hood ø 180 mm	R014022-03		0,00



+ Cast iron hood ø 200 mm	10087	1	
Front variants:			
Door frame, black	 SET210474		4516,00
Additional option for cast iron dome			
Cast iron dome ø 180 mm	D004186		0,00



+ Modular accumulator MAS 440 double-layered	R009042	5	
Cast iron dome MAS ø 180	R009095-01	1	
Mounting ring	10077	1	
Front variants:			
Door frame, black	 SET210476		6328,00
Additional option MAS			
Exchange connectiong piece ø 200 mm	R009105		75,50
Exchange connectiong piece ø 160 mm	07137		75,50

Energy efficiency index A +

Eck-Kamin 51/52/52 side-opening door

Auslaufartikel



Set consists of:	Art.-Nr.	No.	Price
Eck-Kamin 51/52/52 side-opening door, two-piece ceramic glass		1	
Door frame		1	
Chamotte lining set, bright, for Eck-Kamin 51/52/52 u. 57/52/52		1	

Additional options (for all smoke hood variants)			
EAS (see page 11)			2030,00
EAS at DHT			2218,50
Reduced price for EAS without display			-192,50
Revision handle	02426		169,00
Chamotte lining, anthracite	40986-02		273,00

Additional charging door	
left side	right side
1339,00	1339,00

Smoke hood variants:



Cast iron hot air hood ø 200 mm	R014022-01	1	
Front variants:			
Door frame, black		SET210370	5210,00
Additional option for cast iron hot air hood			
Cast iron hot air hood ø 250 mm	R014022-02		0,00
Cast iron hot air hood ø 180 mm	R014022-03		0,00



+ Cast iron hood ø 200 mm	10087	1	
Front variants:			
Door frame, black		SET209986	4990,00
Additional option for cast iron dome			
Cast iron dome ø 180 mm	D004186		0,00



+ Modular accumulator MAS 440 double-layered	R009042	5	
Cast iron dome MAS ø 180	R009095-01	1	
Mounting ring	10077	1	
Front variants:			
Door frame, black		SET209988	6801,50
Additional option MAS			
Exchange connectiong piece ø 200 mm	R009105		75,50
Exchange connectiong piece ø 160 mm	07137		75,50

Energy efficiency index A +

Auslaufartikel



Eck-Kamin 57/52/52 side-opening door

Set consists of:	Art.-Nr.	No.	Price
Eck-Kamin 57/52/52 side-opening door, two-piece ceramic glass		1	
Door frame		1	
Chamotte lining set, bright, for Eck-Kamin 51/52/52 u. 57/52/52		1	

Additional options (for all smoke hood variants)

EAS (see page 11)			2030,00
EAS at DHT			2218,50
Reduced price for EAS without display			-192,50
Revision handle	02426		169,00
Chamotte lining, anthracite	40986-02		273,00

Additional charging door

left side	right side
	
1339,00	1339,00

Smoke hood variants:



Cast iron hot air hood ø 200 mm	R014022-01	1	
Front variants:			
Door frame, black		SET210482	5387,00
Additional option for cast iron hot air hood			
Cast iron hot air hood ø 250 mm	R014022-02		0,00
Cast iron hot air hood ø 180 mm	R014022-03		0,00



+ Cast iron hood ø 200 mm	10087	1	
Front variants:			
Door frame, black		SET209990	5167,50
Additional option for cast iron dome			
Cast iron dome ø 180 mm	D004186		0,00



+ Modular accumulator MAS 440 double-layered	R009042	5	
Cast iron dome MAS ø 180	R009095-01	1	
Mounting ring	10077	1	
Front variants:			
Door frame, black		SET209992	6979,00
Additional option MAS			
Exchange connectiong piece ø 200 mm	R009105		75,50
Exchange connectiong piece ø 160 mm	07137		75,50

Energy efficiency index A +

Eck-Kamin 57/52/52 lifting door

Auslaufartikel



Set consists of:	Art.-Nr.	No.	Price
Eck-Kamin 57/52/52 lifting door, two-piece ceramic glass		1	
Mounting frame		1	
Chamotte lining set, bright, for Eck-Kamin 51/52/52 u. 57/52/52		1	



Additional options (for all smoke hood variants)			
EAS (see page 11)			2030,00
Reduced price for EAS without display			-192,50
Counterweights for non-self closing door	49097		60,50
Chamotte lining, anthracite	40986-02		273,00

Smoke hood variants:





Cast iron hot air hood ø 200 mm	R014022-01	1	
Front variants:			
Mounting frame, black, 50 mm	 SET210377		6671,00
Mounting frame, black, 70 mm	 SET210379		6848,00
Additional option for cast iron hot air hood			
Cast iron hot air hood ø 250 mm	R014022-02		0,00
Cast iron hot air hood ø 180 mm	R014022-03		0,00



+ Cast iron hood ø 200 mm	10087	1	
Front variants:			
Mounting frame, black, 50 mm	 SET210004		6451,50
Mounting frame, black, 70 mm	 SET210006		6628,00
Additional option for cast iron dome			
Cast iron dome ø 180 mm	D004186		0,00



+ Modular accumulator MAS 440 double-layered	R009042	5	
Cast iron dome MAS ø 180	R009095-01	1	
Mounting ring	10077	1	
Front variants:			
Mounting frame, black, 50 mm	 SET210009		8263,00
Mounting frame, black, 70 mm	 SET210011		8439,50
Additional option MAS			
Exchange connection piece ø 200 mm	R009105		75,50
Exchange connection piece ø 160 mm	07137		75,50

Energy efficiency index A +



Auslaufartikel





Eck-Kamin 45/82/48 left side lifting door

Set consists of:	Art.-Nr.	No.	Price
Eck-Kamin 45/82/48 left side lifting door, two-piece ceramic glass		1	
Mounting frame		1	
Chamotte lining set, bright, for Eck-Kamin 45/82/48 left side		1	



Additional options (for all smoke hood variants)			
EAS (see page 11)			2030,00
Reduced price for EAS without display			-192,50
Counterweights for non-self closing door	49097		60,50
Chamotte lining, anthracite	I063038-02		273,00

Smoke hood variants:





Cast iron hot air hood ø 200 mm	R014022-01	1	
Front variants:			
Mounting frame, black, 50 mm	 SET210457		7802,50
Mounting frame, black, 70 mm	 SET210459		7980,00
Additional option for cast iron hot air hood			
Cast iron hot air hood ø 250 mm	R014022-02		0,00
Cast iron hot air hood ø 180 mm	R014022-03		0,00



+ Cast iron hood ø 200 mm	10087	1	
Front variants:			
Mounting frame, black, 50 mm	 SET210448		7583,00
Mounting frame, black, 70 mm	 SET210450		7760,50
Additional option for cast iron dome			
Cast iron dome ø 180 mm	D004186		0,00



+ Modular accumulator MAS 440 double-layered	R009042	5	
Cast iron dome MAS ø 180	R009095-01	1	
Mounting ring	10077	1	
Front variants:			
Mounting frame, black, 50 mm	 SET210453		9394,50
Mounting frame, black, 70 mm	 SET210462		9572,00
Additional option MAS			
Exchange connectiong piece ø 200 mm	R009105		75,50
Exchange connectiong piece ø 160 mm	07137		75,50

Energy efficiency index A +

Eck-Kamin 45/82/48 right side lifting door



Auslaufartikel





Set consists of:	Art.-Nr.	No.	Price
Eck-Kamin 45/82/48 right side lifting door, two-piece ceramic glass		1	
Mounting frame		1	
Chamotte lining set, bright, for Eck-Kamin 45/82/48 right side		1	



Additional options (for all smoke hood variants)			
EAS (see page 11)			2030,00
Reduced price for EAS without display			-192,50
Counterweights for non-self closing door	49097		60,50
Chamotte lining, anthracite	I063019-02		273,00

Smoke hood variants:





Cast iron hot air hood ø 200 mm	R014022-01	1	
Front variants:			
Mounting frame, black, 50 mm	 SET210433		7802,50
Mounting frame, black, 70 mm	 SET210435		7980,00
Additional option for cast iron hot air hood			
Cast iron hot air hood ø 250 mm	R014022-02		0,00
Cast iron hot air hood ø 180 mm	R014022-03		0,00



+ Cast iron hood ø 200 mm	10087	1	
Front variants:			
Mounting frame, black, 50 mm	 SET210423		7583,00
Mounting frame, black, 70 mm	 SET210425		7760,50
Additional option for cast iron dome			
Cast iron dome ø 180 mm	D004186		0,00



+ Modular accumulator MAS 440 double-layered	R009042	5	
Cast iron dome MAS ø 180	R009095-01	1	
Mounting ring	10077	1	
Front variants:			
Mounting frame, black, 50 mm	 SET210428		9394,50
Mounting frame, black, 70 mm	 SET210430		9572,00
Additional option MAS			
Exchange connection piece ø 200 mm	R009105		75,50
Exchange connection piece ø 160 mm	07137		75,50

Energy efficiency index A +



Eck-Kamin 57/82/48 left side lifting door

Set consists of:	Art.-Nr.	No.	Price
Eck-Kamin 57/82/48 left side lifting door, two-piece ceramic glass		1	
Mounting frame		1	
Chamotte lining set, bright, for Eck-Kamin 57/82/48 left side		1	

Additional options (for all smoke hood variants)			
EAS (see page 11)			2030,00
Reduced price for EAS without display			-192,50
Counterweights for non-self closing door	49097		60,50
Chamotte lining, anthracite	I013710-02		273,00

Smoke hood variants:



Cast iron hot air hood ø 200 mm	R014022-01	1	
Front variants:			
Mounting frame, black, 50 mm	SET210392		7988,00
Additional option for cast iron hot air hood			
Cast iron hot air hood ø 250 mm	R014022-02		0,00
Cast iron hot air hood ø 180 mm	R014022-03		0,00



+ Cast iron hood ø 200 mm	10087	1	
Front variants:			
Mounting frame, black, 50 mm	SET210034		7768,00
Additional option for cast iron dome			
Cast iron dome ø 180 mm	D004186		0,00



+ Modular accumulator MAS 440 double-layered	R009042	5	
Cast iron dome MAS ø 180	R009095-01	1	
Mounting ring	10077	1	
Front variants:			
Mounting frame, black, 50 mm	SET210039		9579,50
Additional option MAS			
Exchange connectiong piece ø 200 mm	R009105		75,50
Exchange connectiong piece ø 160 mm	07137		75,50

Energy efficiency index A +

Eck-Kamin 57/82/48 right side lifting door

Auslaufartikel



Set consists of:	Art.-Nr.	No.	Price
Eck-Kamin 57/82/48 right side lifting door, two-piece ceramic glass		1	
Mounting frame		1	
Chamotte lining set, bright, for Eck-Kamin 57/82/48 right side		1	

Additional options (for all smoke hood variants)			
EAS (see page 11)			2030,00
Reduced price for EAS without display			-192,50
Counterweights for non-self closing door	49097		60,50
Chamotte lining, anthracite	I013707-02		273,00

Smoke hood variants:



Cast iron hot air hood ø 200 mm	R014022-01	1	
Front variants:			
Mounting frame, black, 50 mm	SET210397		7988,00
Mounting frame, black, 70 mm	SET210399		8164,50
Additional option for cast iron hot air hood			
Cast iron hot air hood ø 250 mm	R014022-02		0,00
Cast iron hot air hood ø 180 mm	R014022-03		0,00



+ Cast iron hood ø 200 mm	10087	1	
Front variants:			
Mounting frame, black, 50 mm	SET210044		7768,00
Mounting frame, black, 70 mm	SET210046		7945,00
Additional option for cast iron dome			
Cast iron dome ø 180 mm	D004186		0,00



+ Modular accumulator MAS 440 double-layered	R009042	5	
Cast iron dome MAS ø 180	R009095-01	1	
Mounting ring	10077	1	
Front variants:			
Mounting frame, black, 50 mm	SET210049		9579,50
Mounting frame, black, 70 mm	SET210051		9756,50
Additional option MAS			
Exchange connection piece ø 200 mm	R009105		75,50
Exchange connection piece ø 160 mm	07137		75,50

Energy efficiency index A +



Auslaufartikel



Eck-Kamin 45/67/44 left side lifting door

Set consists of:	Art.-Nr.	No.	Price
Eck-Kamin 45/67/44 left side lifting door, two-piece ceramic glass		1	
Mounting frame		1	
Chamotte lining set, bright, for Eck-Kamin 45/67/44 left side		1	

Additional options (for all smoke hood variants)			
EAS (see page 11)			2030,00
Reduced price for EAS without display			-192,50
Counterweights for non-self closing door	49097		60,50
Chamotte lining, anthracite	I062062-02		273,00

Smoke hood variants:



Cast iron hot air hood ø 200 mm	R014022-01	1	
Front variants:			
Mounting frame, black, 50 mm	SET210401		7094,00
Mounting frame, black, 70 mm	SET210403		7270,50
Additional option for cast iron hot air hood			
Cast iron hot air hood ø 250 mm	R014022-02		0,00
Cast iron hot air hood ø 180 mm	R014022-03		0,00



+ Cast iron hood ø 200 mm	10087	1	
Front variants:			
Mounting frame, black, 50 mm	SET210314		6874,50
Mounting frame, black, 70 mm	SET210316		7050,50
Additional option for cast iron dome			
Cast iron dome ø 180 mm	D004186		0,00



+ Modular accumulator MAS 440 double-layered	R009042	5	
Cast iron dome MAS ø 180	R009095-01	1	
Mounting ring	10077	1	
Front variants:			
Mounting frame, black, 50 mm	SET210319		8686,00
Mounting frame, black, 70 mm	SET210321		8862,00
Additional option MAS			
Exchange connectiong piece ø 200 mm	R009105		75,50
Exchange connectiong piece ø 160 mm	07137		75,50

Energy efficiency index A +

Eck-Kamin 45/67/44 right side lifting door



Auslaufartikel



Set consists of:	Art.-Nr.	No.	Price
Eck-Kamin 45/67/44 right side lifting door, two-piece ceramic glass		1	
Mounting frame		1	
Chamotte lining set, bright, for Eck-Kamin 45/67/44 right side		1	

Additional options (for all smoke hood variants)			
EAS (see page 11)			2030,00
Reduced price for EAS without display			-192,50
Counterweights for non-self closing door	49097		60,50
Chamotte lining, anthracite	I062033-02		273,00

Smoke hood variants:



Cast iron hot air hood ø 200 mm	R014022-01	1	
Front variants:			
Mounting frame, black, 50 mm	SET210408		7094,00
Mounting frame, black, 70 mm	SET210410		7270,50
Additional option for cast iron hot air hood			
Cast iron hot air hood ø 250 mm	R014022-02		0,00
Cast iron hot air hood ø 180 mm	R014022-03		0,00



+ Cast iron hood ø 200 mm	10087	1	
Front variants:			
Mounting frame, black, 50 mm	SET210294		6874,50
Mounting frame, black, 70 mm	SET210296		7050,50
Additional option for cast iron dome			
Cast iron dome ø 180 mm	D004186		0,00



+ Modular accumulator MAS 440 double-layered	R009042	5	
Cast iron dome MAS ø 180	R009095-01	1	
Mounting ring	10077	1	
Front variants:			
Mounting frame, black, 50 mm	SET210299		8686,00
Mounting frame, black, 70 mm	SET210301		8862,00
Additional option MAS			
Exchange connection piece ø 200 mm	R009105		75,50
Exchange connection piece ø 160 mm	07137		75,50

Energy efficiency index A +



Auslaufartikel



Eck-Kamin 57/67/44 left side lifting door

Set consists of:	Art.-Nr.	No.	Price
Eck-Kamin 57/67/44 left side lifting door, two-piece ceramic glass		1	
Mounting frame		1	
Chamotte lining set, bright, for Eck-Kamin 57/67/44 left side		1	

Additional options (for all smoke hood variants)			
EAS (see page 11)			2030,00
Reduced price for EAS without display			-192,50
Counterweights for non-self closing door	49097		60,50
Chamotte lining, anthracite	I012341-02		273,00

Smoke hood variants:



Cast iron hot air hood ø 200 mm	R014022-01	1	
Front variants:			
Mounting frame, black, 50 mm	SET210382		7284,00
Mounting frame, black, 70 mm	SET210384		7460,50
Additional option for cast iron hot air hood			
Cast iron hot air hood ø 250 mm	R014022-02		0,00
Cast iron hot air hood ø 180 mm	R014022-03		0,00



+ Cast iron hood ø 200 mm	10087	1	
Front variants:			
Mounting frame, black, 50 mm	SET210014		7064,00
Mounting frame, black, 70 mm	SET210016		7241,00
Additional option for cast iron dome			
Cast iron dome ø 180 mm	D004186		0,00



+ Modular accumulator MAS 440 double-layered	R009042	5	
Cast iron dome MAS ø 180	R009095-01	1	
Mounting ring	10077	1	
Front variants:			
Mounting frame, black, 50 mm	SET210019		8876,00
Mounting frame, black, 70 mm	SET210021		9052,50
Additional option MAS			
Exchange connectiong piece ø 200 mm	R009105		75,50
Exchange connectiong piece ø 160 mm	07137		75,50

Energy efficiency index A +

Eck-Kamin 57/67/44 right side lifting door



Auslaufartikel





Set consists of:	Art.-Nr.	No.	Price
Eck-Kamin 57/67/44 right side lifting door, two-piece ceramic glass		1	
Mounting frame		1	
Chamotte lining set, bright, for Eck-Kamin 57/67/44 right side		1	



Additional options (for all smoke hood variants)			
EAS (see page 11)			2030,00
Reduced price for EAS without display			-192,50
Counterweights for non-self closing door	49097		60,50
Chamotte lining, anthracite	I012340-02		273,00

Smoke hood variants:





Cast iron hot air hood ø 200 mm	R014022-01	1	
Front variants:			
Mounting frame, black, 50 mm	 SET210387		7284,00
Mounting frame, black, 70 mm	 SET210389		7460,50
Additional option for cast iron hot air hood			
Cast iron hot air hood ø 250 mm	R014022-02		0,00
Cast iron hot air hood ø 180 mm	R014022-03		0,00



+ Cast iron hood ø 200 mm	10087	1	
Front variants:			
Mounting frame, black, 50 mm	 SET210024		7064,00
Mounting frame, black, 70 mm	 SET210026		7241,00
Additional option for cast iron dome			
Cast iron dome ø 180 mm	D004186		0,00



+ Modular accumulator MAS 440 double-layered	R009042	5	
Cast iron dome MAS ø 180	R009095-01	1	
Mounting ring	10077	1	
Front variants:			
Mounting frame, black, 50 mm	 SET210029		8876,00
Mounting frame, black, 70 mm	 SET210031		9052,50
Additional option MAS			
Exchange connection piece ø 200 mm	R009105		75,50
Exchange connection piece ø 160 mm	07137		75,50

Energy efficiency index A +

Auslaufartikel



Eck-Kamin 70/33/33 lifting door

Set consists of:	Art.-Nr.	No.	Price
Eck-Kamin 70/33/33 lifting door , two-piece ceramic glass, outlet ø 180 mm		1	
Mounting frame		1	
Chamotte lining set, bright, for Eck-Kamin 70/33/33		1	

Additional options			
EAS (see page 11)			2030,00
Reduced price for EAS without display			-192,50
Counterweights for non-self closing door	49097		60,50
Chamotte lining, anthracite	I065068-02		273,00

Available variants:

Front variants:			
Mounting frame, black, 50 mm		SET210510	6388,00
Mounting frame, black, 70 mm		SET210512	6565,50

Energy efficiency index A +

Eck-Kamin 42/57/30 left side side-opening door



Set consists of:	Art.-Nr.	No.	Price
Eck-Kamin 42/57/30 left side side-opening door , two-piece ceramic glass, outlet ø 200 mm		1	
Door frame or mounting frame		1	
Chamotte lining set, bright, for Eck-Kamin 42/57/30		1	

Additional options			
EAS (see page 11)			2030,00
Reduced price for EAS without display			-192,50
Chamotte lining, anthracite	I068112-02		273,00
Exchange connectiong piece ø 180 mm	I058043		100,00
Exchange connectiong piece ø 160 mm	I058046		100,00

Available variants:

Front variants:			
Door frame, black		SET212679	5530,00
Mounting frame, black 50 mm		SET213036	5614,00

Energy efficiency index A +

Eck-Kamin 42/57/30 right side side-opening door



Set consists of:	Art.-Nr.	No.	Price
Eck-Kamin 42/57/30 right side side-opening door , two-piece ceramic glass, outlet ø 200 mm		1	
Door frame or mounting frame		1	
Chamotte lining set, bright, for Eck-Kamin 42/57/30		1	

Additional options			
EAS (see page 11)			2030,00
Reduced price for EAS without display			-192,50
Chamotte lining, anthracite	I068094-02		273,00
Exchange connectiong piece ø 180 mm	I058043		100,00
Exchange connectiong piece ø 160 mm	I058046		100,00

Available variants:

Front variants:			
Door frame, black		SET212677	5530,00
Mounting frame, black 50 mm		SET213037	5614,00

Energy efficiency index A +

Auslaufartikel



Auslaufartikel



Eck-Kamin 42/57/30 left side lifting door

Set consists of:	Art.-Nr.	No.	Price
Eck-Kamin 42/57/30 left side, two-piece ceramic glass, outlet ø 200 mm		1	
Mounting frame		1	
Chamotte lining set, bright, for Eck-Kamin 42/57/30		1	

Additional options			
EAS (see page 11)			2030,00
Reduced price for EAS without display			-192,50
Chamotte lining, anthracite	I068112-02		273,00
Counterweights for non-self closing door	49097		60,50
Exchange connectiong piece ø 180 mm	I058043		100,00
Exchange connectiong piece ø 160 mm	I058046		100,00

Available variants:

Front variants:			
Mounting frame, black, 50 mm		SET212672	6768,50
Mounting frame, black, 70 mm		SET212674	6945,50

Energy efficiency index A +

Eck-Kamin 42/57/30 right side lifting door

Set consists of:	Art.-Nr.	No.	Price
Eck-Kamin 42/57/30 right side, two-piece ceramic glass, outlet ø 200 mm		1	
Mounting frame		1	
Chamotte lining set, bright, for Eck-Kamin 42/57/30		1	

Additional options			
EAS (see page 11)			2030,00
Reduced price for EAS without display			-192,50
Chamotte lining, anthracite	I068094-02		273,00
Counterweights for non-self closing door	49097		60,50
Exchange connectiong piece ø 180 mm	I058043		100,00
Exchange connectiong piece ø 160 mm	I058046		100,00

Available variants:

Front variants:			
Mounting frame, black, 50 mm		SET212667	6768,50
Mounting frame, black, 70 mm		SET212669	6945,50

Energy efficiency index A +

Architektur-Kamin Eck 38/86/36 left side

Auslaufartikel



Set consists of:	Art.-Nr.	No.	Price
Architektur-Kamin Eck 38/86/36 left side, two-piece ceramic glass, outlet ø 200 mm		1	
Mounting frame		1	
Chamotte lining set, bright, for AK-corner 38/86/36		1	

Additional options			
EAS (see page 11)			2030,00
Reduced price for EAS without display			-192,50
Chamotte lining, anthracite	40959.1-02		273,00
Counterweights for non-self closing door	49097		60,50
Smoke pipe adapter for horizontal/vertical outlet	BSK7000-129		527,00
Exchange connectiong piece ø 180 mm	I058043		100,00

Available variants:

Front variants:			
Mounting frame, black, 50 mm		SET205941	7410,50
Mounting frame, black, 70 mm		SET208777	7587,50

Energy efficiency class A

Architektur-Kamin Eck 38/86/36 right side

Auslaufartikel



Set consists of:	Art.-Nr.	No.	Price
Architektur-Kamin 38/86/36 right side, two-piece ceramic glass, outlet ø 200 mm		1	
Mounting frame		1	
Chamotte lining set, bright, for AK-corner 38/86/36		1	

Additional options			
EAS (see page 11)			2030,00
Reduced price for EAS without display			-192,50
Chamotte lining, anthracite	40959.1-02		273,00
Counterweights for non-self closing door	49097		60,50
Smoke pipe adapter for horizontal/vertical outlet	BSK7000-129		527,00
Exchange connectiong piece ø 180 mm	I058043		100,00

Available variants:

Front variants:			
Mounting frame, black, 50 mm		SET205945	7410,50
Mounting frame, black, 70 mm		SET208779	7587,50

Energy efficiency class A

Auslaufartikel



Architektur-Kamin Eck 45/101/40 left side

Set consists of:	Art.-Nr.	No.	Price
Architektur-Kamin 45/101/40, left side, two-piece ceramic glass, outlet ø 250 mm		1	
Mounting frame		1	
Chamotte lining set, bright, for AK-corner 45/101/40		1	

Additional options

Chamotte lining, anthracite	I051069-2		273,00
Counterweights for non-self closing door	49097		60,50
Smoke pipe adapter for horizontal outlet	I019490		388,50
Exchange connecting piece ø 200 mm	I019449		79,50

Available variants:

Front variants:			
Mounting frame, black, 50 mm		SET207156	9767,50
Mounting frame, black, 70 mm		SET208780	9944,50

Energy efficiency class A

Auslaufartikel



Architektur-Kamin Eck 45/101/40, right side

Set consists of:	Art.-Nr.	No.	Price
Architektur-Kamin 45/101/40, right side, two-piece ceramic glass, outlet ø 250 mm		1	
Mounting frame		1	
Chamotte lining set, bright, for AK-corner 45/101/40		1	

Additional options

Chamotte lining, anthracite	I051069-2		273,00
Counterweights for non-self closing door	49097		60,50
Smoke pipe adapter for horizontal outlet	I019490		388,50
Exchange connecting piece ø 200 mm	I019449		79,50

Available variants:

Front variants:			
Mounting frame, black, 50 mm		SET207160	9767,50
Mounting frame, black, 70 mm		SET208781	9944,50

Energy efficiency class A

Architektur-Kamin Eck 53/121/50 left side



Auslaufartikel



Set consists of:	Art.-Nr.	No.	Price
Architektur-Kamin 53/121/50 left side, two-piece ceramic glass, outlet ø 250 mm		1	
Mounting frame		1	
Chamotte lining set, bright, for AK-corner 53/121/50		1	

Additional options			
Chamotte lining, anthracite	I008362-02		273,00
Counterweights for non-self closing door	49097		60,50
Smoke pipe adapter for horizontal outlet	I019490		388,50
Exchange connectiong pieceø 200 mm	I019449		79,50

Available variants:

Front variants:			
Mounting frame, black, 50 mm		SET205949	10940,00
Mounting frame, black, 70 mm		SET208782	11117,00

Energy efficiency index A +

Architektur-Kamin Eck 53/121/50 right side



Auslaufartikel



Set consists of:	Art.-Nr.	No.	Price
Architektur-Kamin 53/121/50 right side, two-piece ceramic glass, outlet ø 250 mm		1	
Mounting frame		1	
Chamotte lining set, bright, for AK-corner 53/121/50		1	

Additional options			
Chamotte lining, anthracite	I008324-02		273,00
Counterweights for non-self closing door	49097		60,50
Smoke pipe adapter for horizontal outlet	I019490		388,50
Exchange connectiong pieceø 200 mm	I019449		79,50

Available variants:

Front variants:			
Mounting frame, black, 50 mm		SET205953	10940,00
Mounting frame, black, 70 mm		SET208783	11117,00

Energy efficiency index A +



Panorama-Kamin 42/42/42/42

Set consists of:	Art.-Nr.	No.	Price
Panorama-Kamin 42/42/42/42, outlet ø 200 mm		1	
Chamotte lining set Panorama-Kamin 42/42/42/42		1	

Additional options			
EAS (see page 11)			2030,00
Reduced price for EAS without display			-192,50
Counterweights for non-self closing door	49097		60,50
Exchange connecting piece ø 180 mm	I058043		100,00
Chamotte lining, anthracite Cast rear panel	I067002-02		273,00
Turnbuckle for suspending of support elements (per insert 2 pieces required)	O2567		20,00
Black operating handle (railing and air control)	I007352K		169,00

Available variants:

Front variants:			
Panorama frame, narrow, black		SET210478	8387,50
Panorama frame, wide, black		SET210480	8387,50

Energy efficiency class A

Panorama-Kamin 51/50/50/50





Set consists of:	Art.-Nr.	No.	Price
Panorama-Kamin 51/50/50/50, outlet ø 200 mm		1	
Combustion chamber lining Panorama-Kamin 51/50/50/50		1	

Additional options			
EAS (see page 11)			2030,00
Reduced price for EAS without display			-192,50
Counterweights for non-self closing door		included/modification	
Combustion chamber lining black Cast rear panel	I072006-02		273,00
Catalytic converter Panorama-Kamin	I072078		943,00
Carrier unit suspended 51/50/50/50	I072083		939,50
Black operating handle (railing and air control)	I007352K		169,00

Available variants:

Front variants:			
Panorama frame, narrow, black		SET213092	9787,50
Panorama frame, wide, black		SET213093	9787,50
Additional options			
Exchange connectiong piece ø 180 mm	I058043		100,00



+ Modular accumulator MAS 440 double-layered	R009042	3	
Cast iron dome MAS ø 200	R009095-02	1	
Mounting ring	10085.1	1	
Front variants:			
Panorama frame, narrow, black		SET213094	11394,50
Panorama frame, wide, black		SET213095	11394,50

Energy efficiency index A +



Panorama-Kamin 51/66/40/66

Set consists of:	Art.-Nr.	No.	Price
Panorama-Kamin 51/66/40/66, outlet ø 200 mm		1	
Combustion chamber lining Panorama-Kamin 51/66/40/66		1	

Additional options			
EAS (see page 11)			2030,00
Reduced price for EAS without display			-192,50
Counterweights for non-self closing door	included/modification		
Exchange connecting piece ø 180 mm	I058043		100,00
Combustion chamber lining black Cast rear panel	I071009-02		273,00
Carrier unit suspended 51/66/40/66	I071079		972,00
Black operating handle (railing and air control)	I007352K		169,00

Available variants:

Front variants:			
Panorama frame, narrow, black		SET213100	10315,00
Panorama frame, wide, black		SET213101	10315,00

Energy efficiency index A +

Panorama-Kamin 51/66/50/66



Set consists of:	Art.-Nr.	No.	Price
Panorama-Kamin 51/66/50/66, outlet ø 200 mm		1	
Combustion chamber lining Panorama-Kamin 51/66/50/66		1	

Additional options			
EAS (see page 11)			2030,00
Reduced price for EAS without display			-192,50
Counterweights for non-self closing door			included/modification
Exchange connecting piece ø 180 mm	I019448		79,50
Exchange connecting piece ø 250 mm	I019450		79,50
Combustion chamber lining black Cast rear panel	I047130-02		273,00
Carrier unit suspended 51/66/50/66	I047172		1003,50
Black operating handle (railing and air control)	I007352K		169,00

Available variants:

Front variants:			
Panorama frame, narrow, black		SET213102	10922,50
Panorama frame, wide, black		SET213103	10922,50

Energy efficiency index A +

Panorama-Kamin 51/88/50/88



Set consists of:	Art.-Nr.	No.	Price
Panorama-Kamin 51/88/50/88, outlet ø 200 mm		1	
Combustion chamber lining Panorama-Kamin 51/88/50/88		1	

Additional options			
EAS (see page 11)			2030,00
Reduced price for EAS without display			-192,50
Counterweights for non-self closing door			included/modification
Exchange connecting piece ø 180 mm	I019448		79,50
Exchange connecting piece ø 250 mm	I019450		79,50
Combustion chamber lining black Cast rear panel	I048180-02		273,00
Carrier unit suspended 51/88/50/88	I048212		1069,50
Black operating handle (railing and air control)	I007352K		169,00

Available variants:

Front variants:			
Panorama frame, narrow, black		SET213104	11660,50
Panorama frame, wide, black		SET213105	11660,50

Energy efficiency index A +



Panorama-Kamin 70/25/40/25

Set consists of:	Art.-Nr.	No.	Price
Panorama-Kamin 70/25/40/25 , outlet ø 200 mm		1	
Chamotte lining set Panorama-Kamin 70/25/40/25		1	

Additional options			
EAS (see page 11)			2030,00
Reduced price for EAS without display			-192,50
Counterweights for non-self closing door	49097		60,50
Exchange connecting piece ø 180 mm	I058043		100,00
Chamotte lining, anthracite	I066002-02		273,00
Turnbuckle for suspending of support elements (per insert 2 pieces required)	O2567		20,00
Black operating handle (railing and air control)	I007352K		169,00

Available variants:

Front variants:			
Panorama frame, narrow, black		SET210464	9082,50
Panorama frame, wide, black		SET210466	9082,50

Energy efficiency index A +



Panorama-Kamin 57/25/60/25

Set consists of:	Art.-Nr.	No.	Price
Panorama-Kamin 57/25/60/25 , outlet ø 200 mm		1	
Chamotte lining set Panorama-Kamin 57/25/60/25		1	

Additional options			
EAS (see page 11)			2030,00
Reduced price for EAS without display			-192,50
Counterweights for non-self closing door	49097		60,50
Exchange connecting piece ø 180 mm	I019448		79,50
Exchange connecting piece ø 250 mm	I019450		79,50
Connection adapter ø 160 mm for changing the combustion air supply from side to rear	BSK5000-130		151,00
Chamotte lining, anthracite	I053034-02		273,00
Smoke pipe adapter for horizontal/vertical outlet inclusive spare connecting piece	I009168		557,50
Turnbuckle for suspending of support elements (per insert 2 pieces required)	O2567		20,00
Black operating handle (railing and air control)	I007352K		169,00

Available variants:

Front variants:			
Panorama frame, narrow, black		SET207123	8978,50
Panorama frame, wide, black		SET207125	8978,50

Energy efficiency index A +

Panorama-Kamin 57/40/60/40



Set consists of:	Art.-Nr.	No.	Price
Panorama-Kamin 57/40/60/40, outlet ø 200 mm		1	
Chamotte lining set Panorama-Kamin 57/40/60/40		1	

Additional options			
EAS (see page 11)			2030,00
Reduced price for EAS without display			-192,50
Counterweights for non-self closing door	49097		60,50
Exchange connecting piece ø 180 mm	I019448		79,50
Exchange connecting piece ø 250 mm	I019450		79,50
Connection adapter ø 160 mm for changing the combustion air supply from side to rear	BSK5000-130		151,00
Chamotte lining, anthracite	I007312-02		273,00
Smoke pipe adapter for horizontal/vertical outlet inclusive spare connecting piece	I009168		557,50
Turnbuckle for suspending of support elements (per insert 2 pieces required)	02567		20,00
Black operating handle (railing and air control)	I007352K		169,00

Available variants:

Front variants:			
Panorama frame, narrow, black		SET205987	9225,50
Panorama frame, wide, black		SET205989	9225,50

Energy efficiency index A +



Panorama-Kamin 57/25/85/25

Set consists of:	Art.-Nr.	No.	Price
Panorama-Kamin 57/25/85/25, outlet ø 200 mm		1	
Chamotte lining set Panorama-Kamin 57/25/85/25		1	

Additional options			
EAS (see page 11)			2030,00
Reduced price for EAS without display			-192,50
Counterweights for non-self closing door	49097		60,50
Exchange connecting piece ø 180 mm	I019448		79,50
Exchange connecting piece ø 250 mm	I019450		79,50
Connection adapter ø 160 mm for changing the combustion air supply from side to rear	BSK5000-130		151,00
Chamotte lining, anthracite	I050073-02		273,00
Smoke pipe adapter for horizontal/vertical outlet inclusive spare connecting piece	I009168		557,50
Turnbuckle for suspending of support elements (per insert 2 pieces required)	02567		20,00
Black operating handle (railing and air control)	I007352K		169,00

Available variants:

Available variants:			
Panorama frame, narrow, black		SET206983	10040,50
Panorama frame, wide, black		SET206985	10040,50

Energy efficiency index A +

Panorama-Kamin 57/40/85/40



Set consists of:	Art.-Nr.	No.	Price
Panorama-Kamin 57/40/85/40, outlet ø 200 mm		1	
Chamotte lining set Panorama-Kamin 57/40/85/40		1	

Additional options			
EAS (see page 11)			2030,00
Reduced price for EAS without display			-192,50
Counterweights for non-self closing door	49097		60,50
Exchange connecting piece ø 180 mm	I019448		79,50
Exchange connecting piece ø 250 mm	I019450		79,50
Connection adapter ø 160 mm for changing the combustion air supply from side to rear	BSK5000-130		151,00
Chamotte lining, anthracite	I009149-02		273,00
Smoke pipe adapter for horizontal/vertical outlet inclusive spare connecting piece	I009168		557,50
Turnbuckle for suspending of support elements (per insert 2 pieces required)	02567		20,00
Black operating handle (railing and air control)	I007352K		169,00

Available variants:

Available variants:			
Panorama frame, narrow, black		SET205991	10401,50
Panorama frame, wide, black		SET205993	10401,50

Energy efficiency class A



Panorama-Kamin 51/25/101/25

Set consists of:	Art.-Nr.	No.	Price
Panorama-Kamin 51/25/101/25, outlet ø 200 mm		1	
Chamotte lining set Panorama-Kamin 51/25/101/25		1	

Additional options			
EAS (see page 11)			2030,00
Reduced price for EAS without display			-192,50
Counterweights for non-self closing door	49097		60,50
Exchange connecting piece ø 180 mm	I019448		79,50
Exchange connecting piece ø 250 mm	I019450		79,50
Connection adapter ø 160 mm for changing the combustion air supply from side to rear	BSK5000-130		151,00
Chamotte lining, anthracite	I054088-02		273,00
Smoke pipe adapter for horizontal/vertical outlet inclusive spare connecting piece	I009168		557,50
Turnbuckle for suspending of support elements (per insert 2 pieces required)	02567		20,00
Black operating handle (railing and air control)	I007352K		169,00

Available variants:

Available variants:			
Panorama frame, narrow, black		SET209336	11649,50
Panorama frame, wide, black		SET209338	11649,50

Energy efficiency class A

Panorama-Kamin 57/25/121/25



Set consists of:	Art.-Nr.	No.	Price
Panorama-Kamin 57/25/121/25, outlet ø 200 mm		1	
Chamotte lining set Panorama-Kamin 57/25/121/25		1	

Additional options			
EAS (see page 11)			2030,00
Reduced price for EAS without display			-192,50
Counterweights for non-self closing door	49097		60,50
Exchange connecting piece ø 180 mm	I019448		79,50
Exchange connecting piece ø 250 mm	I019450		79,50
Connection adapter ø 160 mm for changing the combustion air supply from side to rear	BSK5000-130		151,00
Chamotte lining, anthracite	I055066-02		273,00
Smoke pipe adapter for horizontal/vertical outlet inclusive spare connecting piece	I009168		557,50
Turnbuckle for suspending of support elements (per insert 2 pieces required)	02567		20,00
Black operating handle (railing and air control)	I007352K		169,00

Available variants:

Available variants:			
Panorama frame, narrow, black		SET209340	12928,50
Panorama frame, wide, black		SET209342	12928,50

Energy efficiency class A



Panorama-Kamin s-fire 42/42/66/42

Set consists of:	Art.-Nr.	No.	Price
Panorama-Kamin s-fire 42/42/66/42 , outlet ø 200 mm		1	
Combustion chamber lining black Panorama-Kamin 42/42/66/42		1	
Counterweights for non-self closing door		1	

Additional options

Exchange connectiong piece ø 180 mm	I058043		100,00
Exchange connectiong piece ø 150 mm	I070092		100,00
Turnbuckle for suspending of support elements (per insert 2 pieces required)	02567		20,00

Available variants:

Front variants:			
Panorama frame, wide, black		I070001-01	8627,50
Panorama frame, wide, stainless steel		I070001-02	9078,00

flat

Tunnel

Eck

Panorama

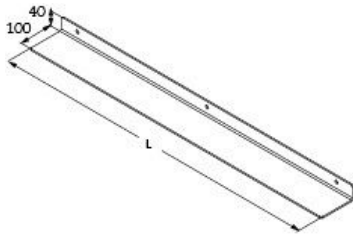

Accessories

Support frame

Article description	Art.-Nr.	Retail price
Mounting bracket flat KK Standard flat side-opening/lifting doors	49099	189,00

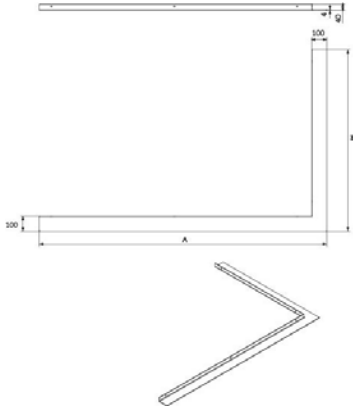

Article description	Art.-Nr.	Retail price
Mounting brackets Eck-Kamin + Architektur-corners		
xx/52/52 lifting door/side opening door	49150	316,00
57/67/44 r/l	49152	353,00
57/82/48 r/l	49152	353,00
Architektur-Eck left side 53/121/50 + 45/101/40	49157	436,00
Architektur-Eck right side 53/121/50 + 45/101/40	49158	436,00

Article description	Art.-Nr.	Retail price
Flexible hose		
ø 125 mm for external air connection	49202	93,00
ø 160 mm for external air connection	49203	113,00



Article description	Art.-Nr.	Retail price
Damper flaps		
Damper flap ø 180 mm	02459	176,00
Damper flap ø 200 mm	02460	192,00
Damper flap ø 250 mm	02461	205,50
Damper flap ø 300 mm	02462	227,50



Article description	Art.-Nr.	Retail price
Modern style handle for damper flaps / smoke valves, with shaft	10275	188,50
Recessed handle for damper flaps / smoke valves, with shaft	900296	215,00
Bediengriff rustikal for damper flaps / smoke valves, with shaft	10274	173,00



Recessed handle

Sissi flap

(suitable for Eck 53/121/50, Tunnel 53/121, Tunnel 53/135, Tunnel 53/166 and the Panorama variants except Panorama 42/42/42/42, 70/25/40/25 und 51/66/40/66)

Article description	Art.-Nr.	Retail price
Sissi flap* for smoke pipe ∅ 180 mm	209300K	636,50
Sissi flap* for smoke pipe ∅ 200 mm	209301K	669,50
Sissi flap* for smoke pipe ∅ 250 mm	209302k	719,00

Sissi flap

(suitable for all other fireplaces with connecting piece dia. = 125 mm)

Article description	Art.-Nr.	Retail price
Sissi flap* for smoke pipe ∅ 180 mm	209300KA	766,50
Sissi flap* for smoke pipe ∅ 200 mm	209301KA	800,00
Sissi flap* for smoke pipe ∅ 250 mm	209302KA	847,50

* consists of additional air supply Z130, fixtures for additional air supply assembly (in D = 180 mm, D = 200 mm or D = 250mm), T-piece (in D = 180 mm, D = 200 mm or D = 250 mm), adjustable clamps 150-170 (2 pcs.), adapter 160/125 mm (only for fireplaces with combustion air supply connection D = 125 mm; Art. No. 209300KA, 209301KA or 209302KA)

For all aforementioned variants, the stainless steel pipe must be ordered separately, specifying the required length.

Article description	Art.-Nr.	Retail price
Round stainless steel hose dia. = 160 mm (according to DIN 4102-A1) for Sissi flap/by metre	900094	56,50
ATTENTION: max. up to 5 metres available		

Schematic drawing

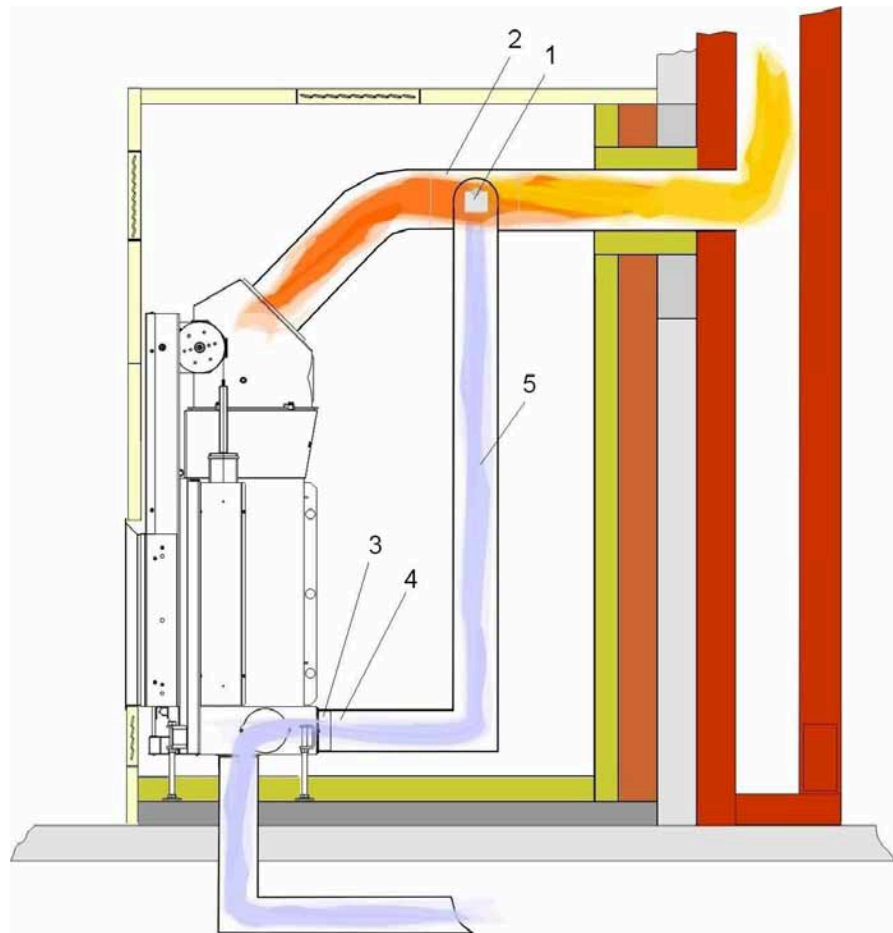

- 1 Supplementary air supply with assembly kit and adjustable clamp
- 2 T-piece
- 3 Combustion air connection \varnothing 125 mm or \varnothing 160 mm with clamp
- 4 Adapter 160/125
- 5 Round stainless steel hose \varnothing 160 mm

The Formats

flat

from
page
102



Urfeuer- open fireplace
50/66
Urfeuer-Kitchen- Fireplace®
50/66



Urfeuer- open fireplace
50/88



Urfeuer- open fireplace
50/110

Door dimensions height x width in cm

Eck corners

from
page
106



Urfeuer- open fireplace
Eck
50/88/44

Door dimensions height x width x width in cm

Panorama formats

from
page
108



Urfeuer- open fireplace
Panorama
50/44/66/44



Urfeuer- open fireplace Panorama
50/44/88/44

Door dimensions height x side width x front width x side width in cm

4free



Urfeuer- open fireplace
4free70

from
page
110

Variants for firing chamber extension

Urfeuer flach

mit Anbaurahmen für Feuerraumfortführung (beige) und modularem Aufbau der Feuerraumfortführung L/R (rot/rosa)

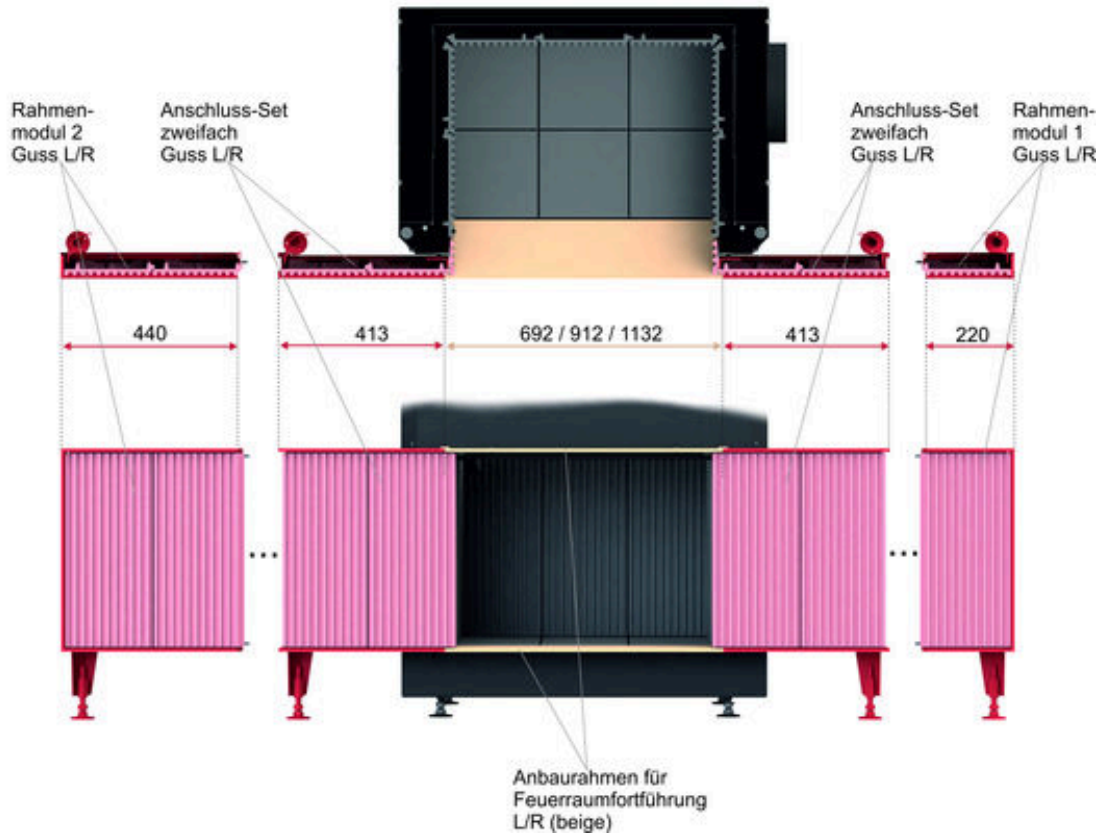

Urfeuer Eck

mit Anbaurahmen für Feuerraumfortführung (beige) und modularem Aufbau der Feuerraumfortführung L/R unter 0° und 90° (rot/rosa)

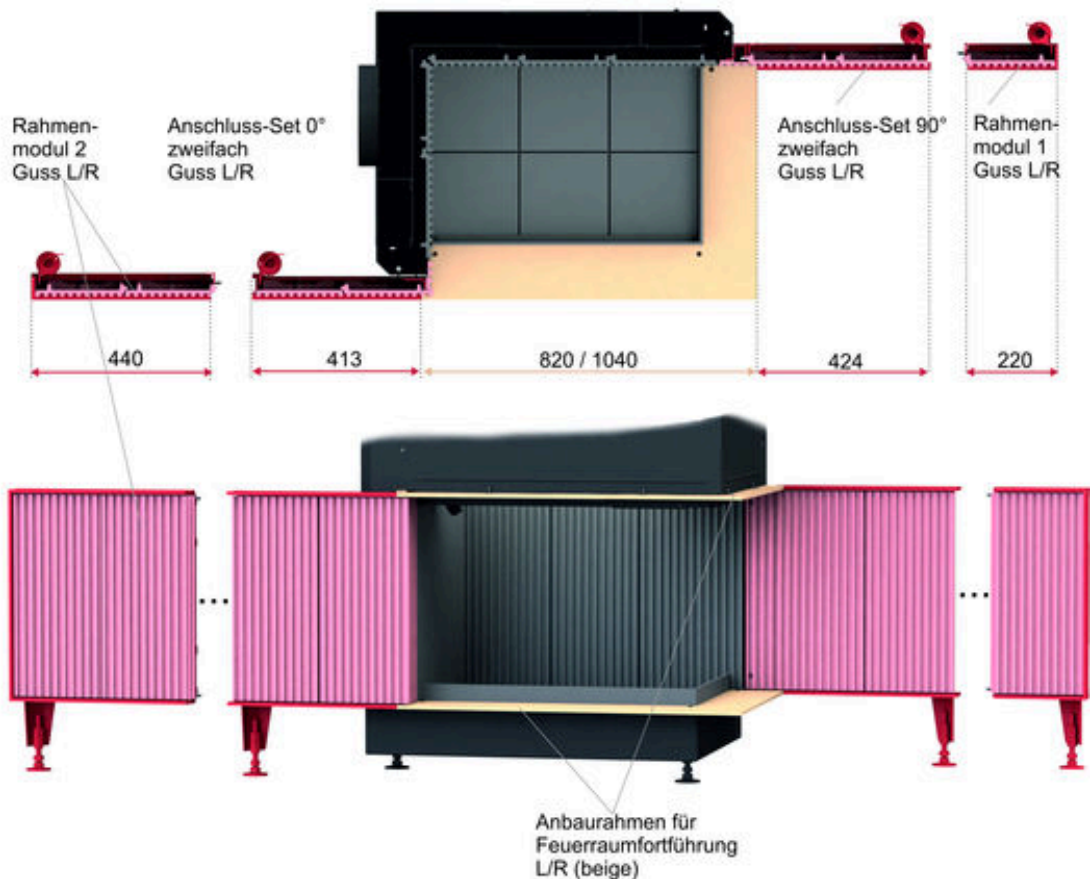

Urfeuer Panorama

mit Anbaurahmen für Feuerraumfortführung (beige) und
modularem Aufbau der Feuerraumfortführung L/R unter 0° und 90° (rot/rosa)

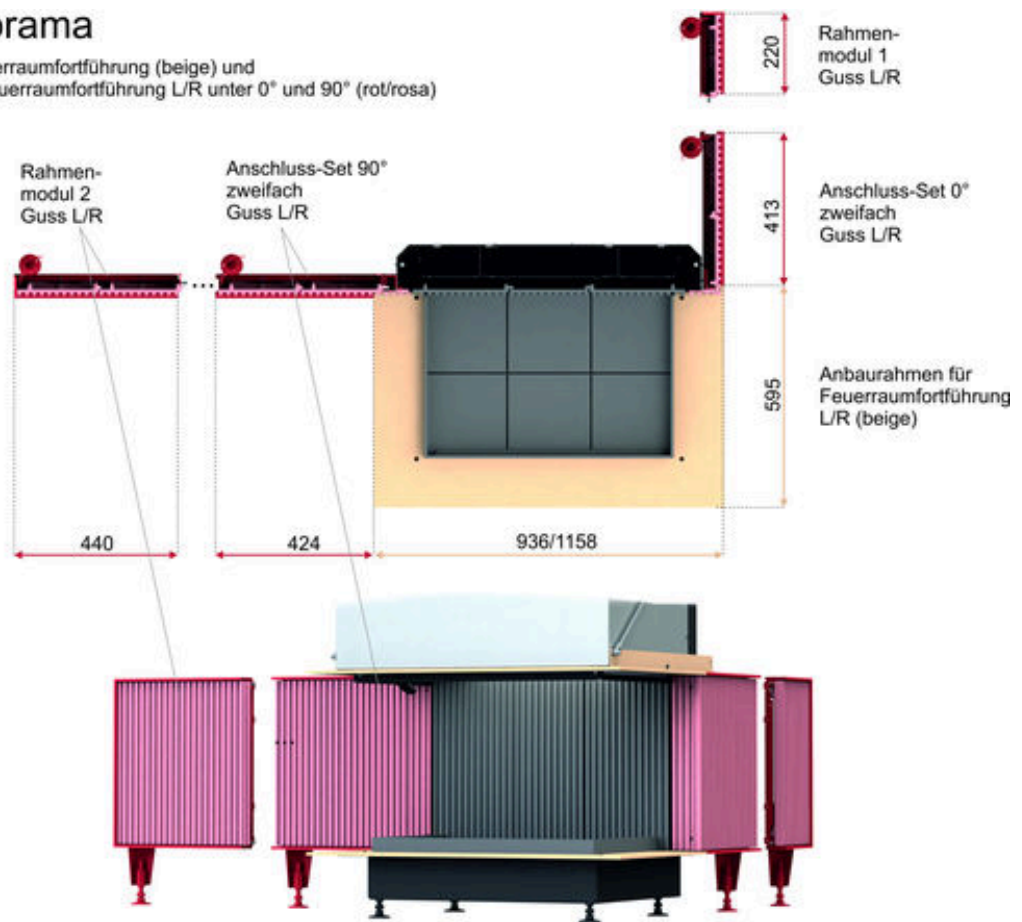



Urfeuer- open fireplace 50/66

Set consists of:	Art.-Nr.	No.	Price
Urfeuer- open fireplace 50/66 outlet ø 300 mm		1	
Mounting frame		1	
Combustion chamber inner lining cast iron		1	

Additional options			
Spare connecting piece ø 250 mm	D015042		136,50

Available variants:

Front variants:			
Mounting frame, black, 60 mm		SET212690	8563,00
Mounting frame, black, 60 mm L/R 2		SET212693	9654,00
Mounting frame, black, 60 mm L2/ R2		SET212695	10585,50

Options for the extension of the firing chamber			
Frame module 1 piece	D020006-01		706,50
Frame module double	D021006-01		836,00

Overview of firing chamber extension (see page 100)
Accessories (see page 112)

Energy efficiency index F

Urfeuer-Kitchen- Fireplace® 50/66



Set consists of:	Art.-Nr.	No.	Price
Urfeuer-Kitchen- Fireplace® 50/66 outlet ø 300 mm		1	
Mounting frame		1	
Combustion chamber inner lining cast iron		1	
Interior lighting combustion chamber		1	
Grill support with new grill grate made of cast iron		1	

Additional options			
Knifeblock set consisting of: Knife block Meat fork 2 x Cooking knife 1 x Utility knife 1 x	SET212773		825,50
Grill drip tray	N006062		288,50
Double-enamelled cast iron oven-pan	K011151		175,50
Spare connecting piece ø 250 mm	D015042		136,50

Available variants:

Front variants:			
Mounting frame, black, 60 mm		SET212722	12497,00
Mounting frame, black, 60 mm L/R 2		SET212724	13587,50
Mounting frame, black, 60 mm L2/ R2		SET212726	14519,00
Functional niche black for kitchen-fire- place Urfeuer		SET212932	13407,50

Options for the extension of the firing chamber			
Frame module 1 piece	D020006-01		706,50
Frame module double	D021006-01		836,00

Overview of firing chamber extension (see page 100)
Accessories (see page 112)

Energy efficiency index F



Urfeuer- open fireplace 50/88

Set consists of:	Art.-Nr.	No.	Price
Urfeuer- open fireplace 50/88 outlet ø 300 mm		1	
Mounting frame		1	
Combustion chamber inner lining cast iron		1	

Available variants:

Front variants:			
Mounting frame, black, 60 mm		SET212685	9097,00
Mounting frame, black, 60 mm L/R 2		SET212686	10198,50
Mounting frame, black, 60 mm L2/ R2		SET212688	11130,00

Options for the extension of the firing chamber			
Frame module 1 piece	D020006-01		706,50
Frame module double	D021006-01		836,00

Overview of firing chamber extension (see page 100)
Accessories (see page 112)

Energy efficiency index F



Urfeuer- open fireplace 50/110

Set consists of:	Art.-Nr.	No.	Price
Urfeuer- open fireplace 50/110 outlet ø 300 mm		1	
Mounting frame		1	
Combustion chamber inner lining cast iron		1	

Available variants:

Front variants:			
Mounting frame, black, 60 mm		SET212728	10041,00
Mounting frame, black, 60 mm L/R 2		SET212729	11148,00
Mounting frame, black, 60 mm L2/ R2		SET212731	12079,50

Options for the extension of the firing chamber			
Frame module 1 piece	D020006-01		706,50
Frame module double	D021006-01		836,00

Overview of firing chamber extension (see page 100)
Accessories (see page 112)

Energy efficiency index F



Urfeuer- open fireplace Eck 50/88/44 L

Set consists of:	Art.-Nr.	No.	Price
Urfeuer- open fireplace Eck 50/88/44 L outlet ø 300 mm		1	
Mounting frame		1	
Combustion chamber inner lining cast iron		1	

Available variants:

Front variants:			
Mounting frame, black, 60 mm		SET212754	10493,50
Mounting frame, black, 60 mm L2,90°		SET212755	11493,50
Mounting frame, black, 60 mm L2,0°		SET212756	11425,00
Mounting frame, black, 60 mm L2,90°/ R2,0°		SET212757	12425,00
Mounting frame, black, 60 mm L2,0°/R2,0°		SET212758	12356,50
Mounting frame, black, 60 mm L2,90°/ L2,90°		SET212759	12493,00

Options for the extension of the firing chamber			
Frame module 1 piece	D020006-01		706,50
Frame module double	D021006-01		836,00

Overview of firing chamber extension (see page 100)

Accessories (see page 112)







Energy efficiency index F



Urfeuer- open fireplace Eck 50/88/44 R

Set consists of:	Art.-Nr.	No.	Price
Urfeuer- open fireplace Eck 50/88/44 R outlet ø 300 mm		1	
Mounting frame		1	
Combustion chamber inner lining cast iron		1	

Available variants:

Front variants:			
Mounting frame, black, 60 mm		SET212760	10493,50
Mounting frame, black, 60 mm R2,90°		SET212761	11493,50
Mounting frame, black, 60 mm R2,0°		SET212762	11425,00
Mounting frame, black, 60 mm R2,90°/ L2,0°		SET212763	12425,00
Mounting frame, black, 60 mm R2,0°/L2,0°		SET212764	12356,50
Mounting frame, black, 60 mm R2,90°/ L2,90°		SET212765	12493,00

Options for the extension of the firing chamber			
Frame module 1 piece	D020006-01		706,50
Frame module double	D021006-01		836,00

Overview of firing chamber extension (see page 100)
Accessories (see page 112)

Energy efficiency index F



Urfeuer- open fireplace Panorama 50/44/66/44

Set consists of:	Art.-Nr.	No.	Price
Urfeuer- open fireplace Panorama 50/44/66/44 outlet ø 300 mm		1	
Mounting frame		1	
Combustion chamber inner lining cast iron		1	

Additional options			
Glass panel with bracket for smoke protection	D024054		187,00

Available variants:

Front variants:			
Mounting frame, black, 60 mm		SET212707	9630,00
Mounting frame, black, 60 mm R2,90°/ L2,90°		SET212766	11629,00
Mounting frame, black, 60 mm R2,0°/L2,0°		SET212767	11492,50

Options for the extension of the firing chamber			
Frame module 1 piece	D020006-01		706,50
Frame module double	D021006-01		836,00

Overview of firing chamber extension (see page 100)
Accessories (see page 112)

Energy efficiency index F



Urfeuer- open fireplace Panorama 50/44/88/44



Set consists of:	Art.-Nr.	No.	Price
Urfeuer- open fireplace Panorama 50/44/88/44 outlet ø 300 mm		1	
Mounting frame		1	
Combustion chamber inner lining cast iron		1	

Additional options			
Glass panel with bracket for smoke protection	D024054		187,00

Available variants:

Front variants:			
Mounting frame, black, 60 mm		SET212768	10443,50
Mounting frame, black, 60 mm L2,90°/ R2,90°		SET212769	12443,00
Mounting frame, black, 60 mm L2,0°/R2,0°		SET212770	12306,50

Options for the extension of the firing chamber			
Frame module 1 piece	D020006-01		706,50
Frame module double	D021006-01		836,00

Overview of firing chamber extension (see page 100)
Accessories (see page 112)

Energy efficiency index F



Urfeuer- open fireplace 4free70

Set consists of:	Art.-Nr.	No.	Price
Urfeuer- open fireplace 4free70 outlet ø 350 mm		1	

Available variants:

Available variants:			
Urfeuer 4free70	D027001		10428,00

Additional options			
Fire table 4free70 wide 1128 x 1128 mm	D027124		995,00
Fire table 4free70 narrow 888 x 888 mm	D027125		673,50
Combustion air connection lower	D027067		308,00
Smoke protection made of glass height 475 mm	D027141		455,00
Extention of ceiling retainer	D027100		926,50
Smoke pipe ø 350, L=1000	S002050		210,50

Accessories (see page 112)

Energy efficiency index F

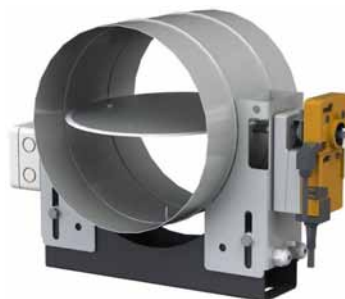
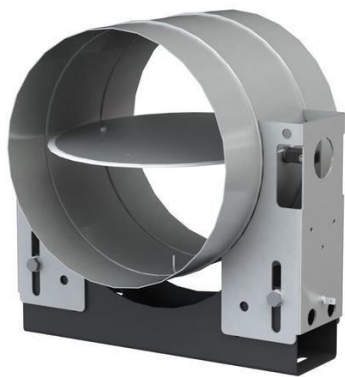

Accessories

Article description	Art.-Nr.	Retail price
Combustion air flap		
Single flap ø 250 mm for manual operation	N003055-01	491,00
Double flap ø 250 mm for manual operation with external grate	N003085-01	748,00
Single flap ø 250 mm motorized	N003055-02	1003,50
Double flap ø 250 mm motorized with external grate	N003085-02	1426,00
Dumper flaps		
Electrical damper flap ø 250 mm	E010032	842,00
Electrical damper flap ø 300 mm	E010033	842,00
Motor for electrical damper flap 4free70 (damper flap is included in delivery content of 4free70)	E010035	648,50

Article description	Art.-Nr.	Retail price
Spare connecting piece ø 250 mm suitable for Urfeuer 50/66	D015042	136,50



Recessed handle



Article description	Art.-Nr.	Retail price
Modern style handle for damper flaps / smoke valves, with shaft	10275	188,50
Recessed handle for damper flaps / smoke valves, with shaft	900296	215,00

Article description	Art.-Nr.	Retail price
Flexible hose ø 250 mm for external air connection	N003104	133,50

Article description	Art.-Nr.	Retail price
Fireclaw with blowpipe and brass mouthpiece	902005	387,50

Glazing formats

Flat glazing

from page 118



HKD 2.2
HKD 2.2 k
HKD 2.2 XL



HKD 2.6
HKD 2.6 k
HKD 6.1



HKD 4.1
HKD 5.1



WF / WFR 25
WF / WFR 33
WF / WFR 50

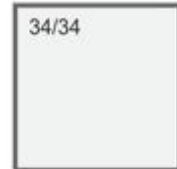

DF 33



HKD 7



HKD 8



HKD 13

Door dimensions height x width in cm

Tunnel formats

from page 146

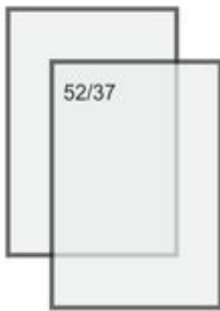

HKD 2.2
HKD 2.2 XL

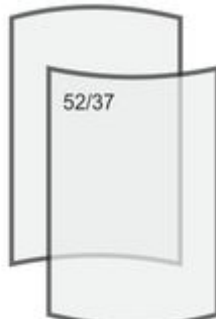

HKD 2.2 r
HKD 2.2 r XL



HKD 7



HKD 8

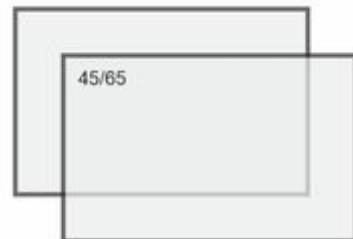

HKD 13

Door dimensions height x width in cm

Round glazing



HKD 2.2 r
HKD 2.2 r k
HKD 2.2 r XL

Door dimensions height x width in cm

Eck corners

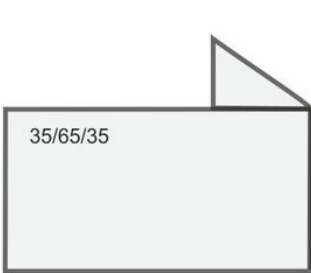

HKD 11

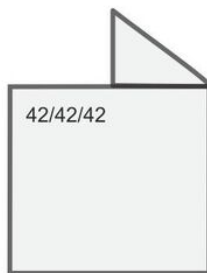

HKD 12

Door dimensions height x width x width in cm

from
page
158

flat

Tiled stoves

from
page
162

Tunnel

round

Eck

Door frame - mounting frame - Tiled stove inserts



Door frame



Mounting frame

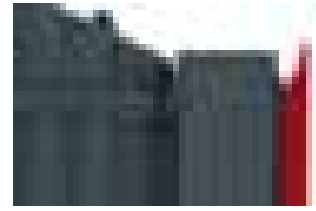

Cast iron frame

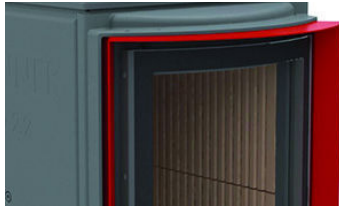
Steel front plate
42 x 79 cmCast iron front plate
42 x 79 cmSteel front plate
48 x 83 cmCast iron front plate
48 x 83 cmDoor frame
R = 330Mounting frame
R = 380

Supplementary equipment

- EAS** Combustion controls with potential-free relay (without additional functions) consisting of display, 1 x flush-mount box, door switch, thermocouple & bus line, each 2 m long. Preassembled EAS/EOS components, door switch, thermocouple, motor box with transmission and \varnothing 125 mm air flap, flexible hose with adjustable clamps
- EOS** Combustion control with graphic touchscreen display and additional functions (differential temperature control, Moritz's flap control) consisting of: Display with control unit, 2 x flush-mount box, door switch, thermocouple, bus and connecting line, each 2 m long, 4 x water sensors with immersion sleeve and 2x extension cable 3 m. Preassembled EOS components: door switch, thermocouple, motor box with transmission and \varnothing 125 mm air flap, flexible hose with adjustable clamps

flat

Tunnel

round

Eck



DF 33 double glazing for connection of a storage mass on site

Set consists of:	Art.-Nr.	No.	Price
DF 33, double glazing		1	
Combustion chamber lining DF 33		1	
Adapter MSS / for on-site connection of a storage mass DF 33		1	

Additional options			
EAS (see page 116)			2030,00
Reduced price for EAS without display			-192,50
The EAS must be taken into account when ordering. Subsequent conversion / retrofitting is no longer possible.			
Doors with self-closing are not available!			
Motorised rotating function			2314,00
Turnbuckle for suspending of support elements (per insert 2 pieces required)	02567		20,00
Socle frame basic element	D028200		943,00

Available variants



Niche cladding 01	SET213024		9442,50
-------------------	-----------	--	----------------

Energy efficiency index A +



DF 33 double glazing with GNF 8

Set consists of:	Art.-Nr.	No.	Price
DF 33, double glazing		1	
Combustion chamber lining DF 33		1	
MSS adapter / direct connection DF 33		1	
GNF 8 without connecting pieces		1	
GNF 8 Connecting piece, inlet ø 180		1	
GNF 8 Connecting piece, outlet ø 160		1	
Support bearing GNF 8		1	
MSS base plate 100		2	
Heat protective panel GNF 8		1	

Additional options			
EAS (see page 116)			2030,00
Reduced price for EAS without display			-192,50
The EAS must be taken into account when ordering. Subsequent conversion / retrofitting is no longer possible.			
Doors with self-closing are not available!			
Motorised rotating function			2314,00
Turnbuckle for suspending of support elements (per insert 2 pieces required)	02567		20,00
Socle frame basic element	D028200		943,00

The flue gas pipes for connection to GNF 8 and MSS must be purchased on site

Available variants



Niche cladding 01	SET213033		11106,00
-------------------	-----------	--	-----------------

Energy efficiency index A +



DF 33 double glazing with Modular Accumulator MAS

Set consists of:	Art.-Nr.	No.	Price
DF 33, double glazing		1	
Combustion chamber lining DF 33		1	
Adapter MAS DF 33		1	
Mounting ring MAS		1	
MAS 440 accumulation stone double-layered		5	
Cast iron dome MAS		1	

Additional options

EAS (see page 116)			2030,00
Reduced price for EAS without display			-192,50

**The EAS must be taken into account when ordering.
Subsequent conversion / retrofitting is no longer possible.**

Doors with self-closing are not available!

Motorised rotating function			2314,00
Turnbuckle for suspending of support elements (per insert 2 pieces required)	02567		20,00
Socle frame basic element	D028200		943,00

Available variants



Niche cladding 01	SET213027		11608,50
-------------------	-----------	--	-----------------

Energy efficiency index A +



DF 33 double glazing with MSS

Set consists of:	Art.-Nr.	No.	Price
DF 33, double glazing		1	
Combustion chamber lining DF 33		1	
MSS adapter / direct connection DF 33		1	
MSS heat storage module 20 cm MAS		2	
MSS elbow 90°		2	
MSS inlet block ø 180, double-layered		1	
MSSI insulating block 30x30 cm		2	
MSS base plate 75		4	
MSS outlet block ø180		1	
MSS steel tape ring		7	
MSS bypass 40 with sealings		1	
MSS heat storage module 20 cm with opening		2	
MSS glue Thermofix 1000 1 kg		1	

Additional options			
EAS (see page 116)			2030,00
Reduced price for EAS without display			-192,50
The EAS must be taken into account when ordering. Subsequent conversion / retrofitting is no longer possible.			
Doors with self-closing are not available!			
Motorised rotating function			2314,00
Turnbuckle for suspending of support elements (per insert 2 pieces required)	02567		20,00
Socle frame basic element	D028200		943,00

The flue gas pipes for connection to GNF 8 and MSS must be purchased on site

Available variants



Niche cladding 01	SET213030		10840,50
-------------------	-----------	--	-----------------

Energy efficiency index A +



DHT middle









HKD 2.2 side-opening door flat glass

Set consists of:	Art.-Nr.	No.	Price
HKD 2.2 DF , single glazing		1	
Door frame or mounting frame		1	
Upper lining for HKD 2.2		1	
Inner lining set for HKD 2.2		1	
Support bearing HKD 2.2		1	









Additional options (for all smoke hood variants)			
EAS (see page 116)			2030,00
Reduced price for EAS without display			-192,50
Additional door DHT middle			1514,50
EAS at DHT			2218,50
Revision handle	02429		91,00
Double glazing			208,00
Door handle black	02056-01		117,00

Smoke hood variants:





+ Cast iron dome ø 180 mm		D009363	1	
Front variants:				
Door frame, black		SET208453		5064,00
Door frame, stainless steel		SET208454		5124,00
Mounting frame, black		SET208455		5195,50
Mounting frame, stainless steel		SET208457		5338,50
Steel front plate 48 x 83 cm		SET208459		5233,00
Cast iron front plate 48 x 83 cm		SET208460		5200,00



+ Cast iron cover ø 180 mm and cast iron heat exchanger rings		R015006-02	2	
Front variants:				
Door frame, black		SET213327		6426,00
Door frame, stainless steel		SET213328		6485,50
Mounting frame, black		SET213329		6557,00
Mounting frame, stainless steel		SET213330		6700,00
Steel front plate 48 x 83 cm		SET213331		6595,00
Cast iron front plate 48 x 83 cm		SET213332		6562,00
Alternative article: connection piece eccentric instead of cast iron dome				
Connection piece eccentric ø 180 mm		S003024		-184,50
Connection piece eccentric ø 200 mm		S003025		-184,50
Additional options				
90° bend - dumper flap and cleaning ø 180 mm		S002198		274,50
90° bend - dumper flap and cleaning ø 200 mm		S002208		295,00



+ Cast iron dome ø 180 mm low	D003664	1	
Front variants:			
Door frame, black		SET212881	5334,00
Door frame, stainless steel		SET212882	5393,50
Mounting frame, black		SET212883	5465,00
Mounting frame, stainless steel		SET212884	5608,00
Steel front plate 48 x 83 cm		SET212886	5503,00
Cast iron front plate 48 x 83 cm		SET212887	5470,00



+ Modular accumulator MAS 440 double-layered	R009042	5	
Cast iron dome MAS ø 180	R009095-01	1	
Mounting ring	10077	1	
Front variants:			
Door frame, black		SET212825	6819,00
Door frame, stainless steel		SET212826	6879,00
Mounting frame, black		SET212827	6950,50
Mounting frame, stainless steel		SET212828	7093,50
Steel front plate 48 x 83 cm		SET212830	6988,00
Cast iron front plate 48 x 83 cm		SET212831	6955,00
Additional option MAS			
Exchange connectiong piece ø 200 mm	R009105		75,50
Exchange connectiong pieceø 160 mm	07137		75,50

Energy efficiency index A +



HKD 2.2 k side-opening door flat glass

Set consists of:	Art.-Nr.	No.	Price
HKD 2.2 k DF , single glazing		1	
Door frame or mounting frame		1	
Inner lining set for HKD 2.2 k		1	
Upper lining for HKD 2.2 k		1	
Support bearing HKD 2.2 k		1	

Additional options			
EAS (see page 116)			2030,00
Reduced price for EAS without display			-192,50
Double glazing			208,00
Door handle black	02056-01		117,00
MAS (see page 346)			

Available variants:

Front variants:				
Door frame, black		SET208497		4964,50
Door frame, stainless steel		SET208498		5024,50
Mounting frame, black		SET208499		5096,00
Mounting frame, stainless steel		SET208500		5239,00
Steel front plate 48 x 83 cm		SET208502		5133,50
Cast iron front plate 48 x 83 cm		SET208503		5100,50

Energy efficiency index A +

HKD 2.2 XL side-opening door flat glass







Set consists of:	Art.-Nr.	No.	Price
HKD 2.2 XL DF , single glazing		1	
Door frame or mounting frame		1	
Inner lining set for HKD 2.2 XL		1	
Upper lining for HKD 2.2 XL		1	
Support bearing HKD 2.2 XL		1	





Additional options			
EAS (see page 116)			2030,00
Reduced price for EAS without display			-192,50
Additional door DHT middle			1514,50
EAS at DHT			2218,50
Revision handle	02429		91,00
Double glazing			208,00
Door handle black	02056-01		117,00

Smoke hood variants:



+ Cast iron dome ø 180 mm		D009363	1	
Front variants:				
Door frame, black		SET208214		5788,50
Door frame, stainless steel		SET208215		5848,00
Mounting frame, black		SET208216		5919,50
Mounting frame, stainless steel		SET208217		6062,50
Steel front plate 48 x 83 cm		SET208268		5957,50
Cast iron front plate 48 x 83 cm		SET208269		5924,00



+ Cast iron dome ø 180 mm low		D003664	1	
Front variants:				
Door frame, black		SET212893		6058,00
Door frame, stainless steel		SET212894		6118,00
Mounting frame, black		SET212895		6189,50
Mounting frame, stainless steel		SET212896		6332,50
Steel front plate 48 x 83 cm		SET212898		6227,00
Cast iron front plate 48 x 83 cm		SET212899		6194,00

Energy efficiency index A +



HKD 2.6 side-opening door flat glass

Set consists of:	Art.-Nr.	No.	Price
HKD 2.6 DF, Double glazing		1	
Door frame or mounting frame, front plate		1	
Upper lining for HKD 2.6		1	
Inner lining set for HKD 2.6		1	
Support bearing HKD 2.6		1	



Additional options (for all smoke hood variants)			
EAS (see page 116)			2030,00
Reduced price for EAS without display			-192,50
Door handle black	02056-01		117,00

Smoke hood variants:



+ Cast iron dome ø 180 mm	D009363	1	
Front variants:			
Door frame, black	 SET208513		5147,50
Cast iron frame black	 SET208515		5165,00





+ Cast iron cover ø 180 mm and cast iron heat exchanger rings	R015006-02	2	
Front variants:			
Door frame, black	 SET213333		6509,00
Cast iron frame black	 SET213334		6526,50
Alternative article: connection piece eccentric instead of cast iron dome			
Connection piece eccentric ø 180 mm	 S003024		-184,50
Connection piece eccentric ø 200 mm	S003025		-184,50
Additional options			
90° bend - dumper flap and cleaning ø 180 mm	S002198		274,50
90° bend - dumper flap and cleaning ø 200 mm	S002208		295,00



+ Cast iron dome ø 180 mm low	D003664	1	
Front variants:			
Door frame, black	 SET212924		5417,00
Cast iron frame black	 SET212926		5434,50



+ Modular accumulator MAS 440 double-layered	R009042	5	
Cast iron dome MAS ø 180	R009095-01	1	
Mounting ring	10077	1	
Front variants:			
Door frame, black	 SET212928		6902,50
Cast iron frame black	 SET212930		6920,00
Additional option MAS			
Exchange connectiong piece ø 200 mm	R009105		75,50
Exchange connectiong pieceø 160 mm	07137		75,50

Energy efficiency index A +



HKD 2.6 k side-opening door flat glass

Set consists of:	Art.-Nr.	No.	Price
HKD 2.6 k DF , Double glazing		1	
Door frame or mounting frame		1	
Inner lining set for HKD 2.6 k		1	
Upper lining for HKD 2.6 k		1	
Support bearing HKD 2.6 k		1	

Additional options			
EAS (see page 116)			2030,00
Reduced price for EAS without display			-192,50
Door handle black	02056-01		117,00

Available variants:

Front variants:			
Door frame, black		SET208517	5028,50
Cast iron frame, black		SET208519	5046,00

Energy efficiency index A +

HKD 4.1 side-opening door flat glass









DHT



Set consists of:	Art.-Nr.	No.	Price
HKD 4.1 DF , single glazing		1	
Door frame or mounting frame, front plate		1	
Inner lining set for HKD 4.1		1	
Upper lining for HKD 4.1		1	
Support bearing HKD 4.1		1	

Additional options			
EAS (see page 116)			2030,00
Reduced price for EAS without display			-192,50
Additional door DHT middle			1391,00
EAS at DHT			2218,50
Revision handle	02429		91,00
Conversion kit LH door	900110		62,00
Double glazing			0,00
Door handle black	02056-01		117,00

Available variants:

Front variants:			
Door frame, black		SET208541	5020,00
Door frame, stainless steel		SET208542	5121,50
Mounting frame, black		SET208725	5072,00
Mounting frame, stainless steel		SET208726	5166,00
Cast iron frame		SET208544	5050,00
Steel front plate, black 48 x 83 cm		SET208545	5219,00
Cast iron front plate 48 x 83 cm		SET208547	5150,00

Energy efficiency index A +

HKD 4.1 side-opening door cast iron doors



DHT middle



Set consists of:	Art.-Nr.	No.	Price
HKD 4.1 , cast iron doors		1	
Blend/ frontplate		1	
Inner lining set for HKD 4.1		1	
Upper lining for HKD 4.1		1	
Support bearing HKD 4.1		1	

Additional options			
EAS (see page 116)			2030,00
Reduced price for EAS without display			-192,50
Additional door DHT middle			1391,00
EAS at DHT			2218,50
Conversion kit LH door	900110		62,00
Revision handle	02429		91,00
Door handle black	02056-01		117,00

Available variants:

Front variants:			
Cast iron frame, black		SET208558	5050,00
Cast iron front plate 48 x 83 cm		SET208559	5150,00

Energy efficiency index A +



DHT









HKD 5.1 side-opening door flat glass

Set consists of:	Art.-Nr.	No.	Price
HKD 5.1 DF , single glazing		1	
Door frame or mounting frame, front plate		1	
Inner lining set for HKD 5.1		1	
Upper lining for HKD 5.1		1	
Support bearing HKD 5.1		1	

Additional options			
EAS (see page 116)			2030,00
Reduced price for EAS without display			-192,50
Additional door DHT middle			1391,00
EAS at DHT			2218,50
Revision handle	02429		91,00
Conversion kit LH door	900110		62,00
Double glazing			0,00
Door handle black	02056-01		117,00

Available variants:

Front variants:			
Door frame, black		SET208574	4689,00
Door frame, stainless steel		SET208575	4790,50
Mounting frame, black		SET208729	4741,00
Mounting frame, stainless steel		SET208730	4835,50
Cast iron frame		SET208576	4719,00
Steel front plate, black 48 x 83 cm		SET208577	4888,00
Cast iron front plate 48 x 83 cm		SET208579	4819,00

Energy efficiency index A +

HKD 5.1 side-opening door cast iron doors

Set consists of:	Art.-Nr.	No.	Price
HKD 5.1 , cast iron doors		1	
Blend/ frontplate		1	
Inner lining set for HKD 5.1		1	
Upper lining for HKD 5.1		1	
Support bearing HKD 5.1		1	

Additional options			
EAS (see page 116)			2030,00
Reduced price for EAS without display			-192,50
Additional door DHT middle			1391,00
EAS at DHT			2218,50
Conversion kit LH door	900110		62,00
Revision handle	02429		91,00
Door handle black	02056-01		117,00

Available variants:

Front variants:			
Cast iron frame, black		SET208584	4719,00
Cast iron front plate 48 x 83 cm		SET208585	4819,00

Energy efficiency index A +



DHT middle









HKD 6.1 side-opening door flat glass



Set consists of:	Art.-Nr.	No.	Price
HKD 6.1 DF , single glazing		1	
Blend/ frontplate		1	
Inner lining set for HKD 6.1		1	
Upper lining for HKD 6.1		1	
Support bearing HKD 6.1		1	

Additional options			
EAS (see page 116)			2030,00
Reduced price for EAS without display			-192,50
Conversion kit LH door	900110		62,00
Double glazing			0,00
Door handle black	02056-01		117,00

Available variants:

Front variants:			
Door frame, black		SET208587	3440,00
Door frame, stainless steel		SET208588	3517,00
Cast iron frame, black		SET208589	3457,50
Steel front plate, black 42 x 79 cm		SET208590	3634,00
Steel front plate, black 48 x 83 cm		SET208592	3675,00
Cast iron front plate, 48 x 83 cm		SET210404	3631,50

Energy efficiency index A +



HKD 6.1 side-opening door cast iron doors



Set consists of:	Art.-Nr.	No.	Price
HKD 6.1 , cast iron doors		1	
Blend/ frontplate		1	
Inner lining set for HKD 6.1		1	
Upper lining for HKD 6.1		1	
Support bearing HKD 6.1		1	

Additional options			
EAS (see page 116)			2030,00
Reduced price for EAS without display			-192,50
Conversion kit LH door	900110		62,00
Door handle black	02056-01		117,00

Available variants:

Front variants:			
Cast iron frame, black		SET208599	3457,50
Cast iron front plate 42 x 79 cm		SET208600	3606,00
Cast iron front plate 48 x 83 cm		SET210405	3631,50

Energy efficiency index A +



HKD 7 side-opening door flat glass

Set consists of:	Art.-Nr.	No.	Price
HKD 7 DF, single glazing		1	
Mounting frame		1	
Inner lining set for HKD 7		1	
Support bearing HKD 7		1	



Additional options (for all smoke hood variants)			
EAS (see page 116)			2030,00
Reduced price for EAS without display			-192,50
Double glazing			208,00
Door hinge self-closing	D030134		84,50
Door handle black	02056-01		117,00

Smoke hood variants:



+ Cast iron dome ø 180 mm	D004186	1	
Front variants:			
Mounting frame, black	 SET212697		6186,50
Door frame, black	 SET212732		6205,00
Additional option for cast iron dome			
Cast iron hood ø 200 mm	10087		0,00





+ Cast iron cover ø 180 mm and cast iron heat exchanger rings	R015006-02	2	
Front variants:			
Mounting frame, black	 SET213233		7605,00
Door frame, black	 SET213234		7623,00
Alternative article: connection piece eccentric instead of cast iron dome			
Connection piece eccentric ø 180 mm	 S003024		-184,50
Connection piece eccentric ø 200 mm	S003025		-184,50
Additional options			
90° bend - dumper flap and cleaning ø 180 mm	S002198		274,50
90° bend - dumper flap and cleaning ø 200 mm	S002208		295,00



+ Cast iron dome ø 180 mm low	D016042	1	
Front variants:			
Mounting frame, black	 SET212708		6513,00
Door frame, black	 SET212733		6531,00



+ Modular accumulator MAS 440 double-layered		R009042	7	
Cast iron dome MAS ø 180		R009095-01	1	
Mounting ring		10077	1	
Front variants:				
Mounting frame, black		SET212699		8557,50
Door frame, black		SET212734		8575,50
Additional option MAS				
Exchange connectiong piece ø 200 mm		R009105		75,50
Exchange connectiong pieceø 160 mm		07137		75,50

Energy efficiency index A +



HKD 8 side-opening door flat glass

Set consists of:	Art.-Nr.	No.	Price
HKD 8 DF, single glazing		1	
Inner lining set for HKD 8		1	
Support bearing HKD 8		1	

Additional options (for all smoke hood variants)



EAS (see page 116)			2030,00
Reduced price for EAS without display			-192,50
Double glazing			208,00
Construction plates for door frame HKD 8	SET212720		216,00

Attention:

The choice of door variant (left or right closing doors) and the EOS/EAS option must be already made when placing the order. Later modifications are not possible anymore! Selfclosing doors are not available!

Smoke hood variants:



+ Cast iron dome ø 180 mm	D004186	1	
Front variants:			
Mounting bracket, black	 SET212701		6660,50
Door frame, black	 SET212740		7294,50
Additional option for cast iron dome			
Cast iron hood ø 200 mm	10087		





+ Cast iron cover ø 180 mm and cast iron heat exchanger rings	R015006-02	2	
Front variants			
Mounting bracket, black	 SET213235		8079,00
Door frame, black	 SET213236		8712,50
Alternative article: connection piece eccentric instead of cast iron dome			
Connection piece eccentric ø 180 mm	 S003024		-184,50
Connection piece eccentric ø 200 mm	S003025		-184,50
Additional options			
90° bend - dumper flap and cleaning ø 180 mm	S002198		274,50
90° bend - dumper flap and cleaning ø 200 mm	S002208		295,00



+ Cast iron dome ø 180 mm low	D016042	1	
Front variants:			
Mounting bracket, black	 SET212710		6987,00
Door frame, black	 SET212741		7620,50



+ Modular accumulator MAS 440 double-layered		R009042	7	
Cast iron dome MAS ø 180		R009095-01	1	
Mounting ring		10077	1	
Front variants:				
Mounting bracket, black		SET212702		9031,00
Door frame, black		SET212742		9665,00
Additional option MAS				
Exchange connectiong piece ø 200 mm		R009105		75,50
Exchange connectiong pieceø 160 mm		07137		75,50

Energy efficiency index A +



HKD 13 side-opening door flat glass

Set consists of:	Art.-Nr.	No.	Price
HKD 13 DF, single glazing		1	
Mounting frame		1	
Inner lining set for HKD 13		1	
Support bearing HKD 13		1	



Additional options (for all smoke hood variants)			
EAS (see page 116)			2030,00
Reduced price for EAS without display			-192,50
Glass ceramic coated (GKB)			142,50
Door hinge self-closing	D030134		84,50
Door handle black	02056-01		117,00
Catalyst module BKH 5.0 / HKD 13	HK000210		1132,50

Smoke hood variants:



+ Cast iron dome ø 180 mm	D004186	1	
Front variants:			
Mounting frame, black		SET213249	7000,50
Door frame, black		SET213250	7014,00
Additional option for cast iron dome			
Cast iron hood ø 200 mm	10087		0,00





+ Cast iron cover ø 180 mm and cast iron heat exchanger rings	R015006-02	2	
Front variants:			
Mounting frame, black		SET213251	8419,00
Door frame, black		SET213252	8432,50
Alternative article: connection piece eccentric instead of cast iron dome			
Connection piece eccentric ø 180 mm		S003024	-184,50
Connection piece eccentric ø 200 mm	S003025		-184,50
Additional options			
90° bend - dumper flap and cleaning ø 180 mm	S002198		274,50
90° bend - dumper flap and cleaning ø 200 mm	S002208		295,00



+ Cast iron dome ø 180 mm low	D016042	1	
Front variants:			
Mounting frame, black		SET213253	7327,00
Door frame, black		SET213254	7340,50



+ Modular accumulator MAS 440 double-layered		R009042	7	
Cast iron dome MAS ø 180		R009095-01	1	
Mounting ring		10077	1	
Front variants:				
Mounting frame, black		SET213255		9371,00
Door frame, black		SET213256		9384,50
Additional option MAS				
Exchange connectiong piece ø 200 mm		R009105		75,50
Exchange connectiong pieceø 160 mm		07137		75,50

Energy efficiency index A +



WF 25 single glazed

Set consists of:	Art.-Nr.	No.	Price
WF 25 single glazed black outlet ø 145 mm		1	
Combustion chamber lining WF 25		1	

Additional options			
*EAS (see page 116)			2030,00
Reduced price for EAS without display			-192,50
Air connecting piece	C011037		58,50
Support bearing WF 25	N002104		249,50
Exchange connecting piece ø 160 mm	07137		75,50
Exchange connecting piece ø 180 mm	07139		75,50
For version with EAS only 180 mm ø connecting piece possible			

Door-version:	Art.-Nr.	No.	Price
Cast iron door inlay	C011106	1	152,00
Cast iron door inlay	C011106m	1	90,50
Assembly at the factory			

Available variants:

Front variants:			
Cast iron front plate 83/48 cm		SET211023	3195,50
Cast iron front plate 79/42 cm		SET211024	3195,50
Cast iron front plate 89,5/48 cm		SET211027	3365,50
Cast iron front plate 106/48 cm		SET212980	3705,50

*For the EAS variant, the air connecting piece is already included.

Energy efficiency index A +

WF 33 single glazed







Set consists of:	Art.-Nr.	No.	Price
WF 33 single glazed black outlet ø 180 mm		1	
Combustion chamber lining WF 33		1	

Additional options			
*EAS (see page 116)			2030,00
Reduced price for EAS without display			-192,50
Air connecting piece	C011037		58,50
Support bearing WF 33	N002088		249,50
Setting steel plate 200 mm depth for 106 x 48 cm front pannel	C014086		113,00
Exchange connecting piece ø 145 mm	R014013		75,50
Exchange connecting piece ø 160 mm	07137		75,50
For version with EAS only 180 mm ø connecting piece possible			

Door-version:	Art.-Nr.	No.	Price
Cast iron door inlay	C011106	1	152,00
Cast iron door inlay	C011106m	1	90,50
Assembly at the factory			

Available variants:

Front variants:			
Cast iron front plate 83/48 cm		SET211612	3195,50
Cast iron front plate 83/52 cm		SET213130	3390,50
Cast iron front plate 79/42 cm		SET211974	3195,50
Cast iron front plate 89,5/48 cm		SET211025	3365,50
Cast iron front plate 106/48 cm		SET212978	3705,50

*For the EAS variant, the air connecting piece is already included.

Energy efficiency index A +







WF 50 single glazed

Set consists of:	Art.-Nr.	No.	Price
WF 50 single glazed black outlet ø 180 mm		1	
Combustion chamber lining WF 50		1	

Additional options			
*EAS (see page 116)			2030,00
Reduced price for EAS without display			-192,50
Air connecting piece	C011037		58,50
Support bearing WF 50	N002090		266,00
Setting steel plate 200 mm depth for 106 x 48 cm front pannel	C014086		113,00
Exchange connecting piece ø 145 mm	R014013		75,50
Exchange connecting piece ø 160 mm	07137		75,50
For version with EAS only 180 mm ø connecting piece possible			

Door-version:	Art.-Nr.	No.	Price
Cast iron door inlay	C011106	1	152,00
Cast iron door inlay	C011106m	1	90,50
Assembly at the factory			

Available variants:

Front variants:			
Cast iron front plate 83/48 cm		SET211613	3916,50
Cast iron front plate 83/52 cm		SET213131	4110,50
Cast iron front plate 79/42 cm		SET211975	3916,50
Cast iron front plate 89,5/48 cm		SET211026	4086,50
Cast iron front plate 106/48 cm		SET212979	4426,00

*For the EAS variant, the air connecting piece is already included.

Energy efficiency index A +

WF_R 25 single glazed



Set consists of:	Art.-Nr.	No.	Price
WF_R 25 single glazed black outlet ø 145 mm		1	
Combustion chamber lining WF _R 25		1	

Additional options			
Air connecting piece	C011037		58,50
Support bearing WF _R 25	N002104		249,50
Exchange connecting piece ø 160 mm	07137		75,50
Exchange connecting piece ø 180 mm	07139		75,50



Door-version:	Art.-Nr.	No.	Price
Cast iron door inlay	C011106	1	152,00
Cast iron door inlay	C011106m	1	90,50
Assembly at the factory			

Available variants:

Front variants:			
Cast iron front plate 83/48 cm		SET212972	3314,50
Cast iron front plate 79/42 cm		SET212973	3314,50
Cast iron front plate 89,5/48 cm		SET212974	3484,50
Cast iron front plate 106/48 cm		SET212983	3824,00

Energy efficiency index A +



WFR 33 single glazed

Set consists of:	Art.-Nr.	No.	Price
WFR 33 single glazed black outlet ø 180 mm		1	
Combustion chamber lining WFR 33		1	

Additional options			
Air connecting piece	C011037		58,50
Support bearing WFR 33	N002088		249,50
Setting steel plate 200 mm depth for 106 x 48 cm front panel	C014086		113,00
Exchange connecting piece ø 145 mm	R014013		75,50
Exchange connecting piece ø 160 mm	07137		75,50

Door-version:	Art.-Nr.	No.	Price
Cast iron door inlay	C011106	1	152,00
Cast iron door inlay	C011106m	1	90,50
Assembly at the factory			

Available variants:

Front variants:				
Cast iron front plate 83/48 cm		SET212933		3314,50
Cast iron front plate 83/52 cm		SET213385		3509,50
Cast iron front plate 79/42 cm		SET212934		3314,50
Cast iron front plate 89,5/48 cm		SET212935		3484,50
Cast iron front plate 106/48 cm		SET212981		3824,00

Energy efficiency index A +







WF_R 50 single glazed

Set consists of:	Art.-Nr.	No.	Price
WF_R 50 single glazed black outlet ø 180 mm		1	
Combustion chamber lining WF _R 50		1	

Additional options			
Air connecting piece	C011037		58,50
Support bearing WF _R 50	N002090		266,00
Setting steel plate 200 mm depth for 106 x 48 cm front pannel	C014086		113,00
Exchange connecting piece ø 145 mm	R014013		75,50
Exchange connecting piece ø 160 mm	07137		75,50

Door-version:	Art.-Nr.	No.	Price
Cast iron door inlay	C011106	1	152,00
Cast iron door inlay	C011106m	1	90,50
Assembly at the factory			

Available variants:

Front variants:			
Cast iron front plate 83/48 cm		SET212975	4029,50
Cast iron front plate 83/52 cm		SET213386	4224,50
Cast iron front plate 79/42 cm		SET212976	4029,50
Cast iron front plate 89,5/48 cm		SET212977	4200,50
Cast iron front plate 106/48 cm		SET212982	4539,50

Energy efficiency index A +

flat

Tiled stoves

Tunnel

round

Eck



Ortrander Heizeinsätze

Designation	Art.-Nr.	No.	Price
Ortrand 3020.61 outlet ø 160 mm	11005.1		2452,50

Additional options

Ortrand GR1.0 Cast iron radiator	11021		689,50
----------------------------------	-------	--	--------

Energy efficiency index A +



Designation	Art.-Nr.	No.	Price
Ortrand 4020.61 outlet ø 160 mm	11006.1		2730,00

Additional options

Ortrand GR1.0 Cast iron radiator	11021		689,50
----------------------------------	-------	--	--------

Energy efficiency index A +

flat

Tunnel

round

Eck



HKD 2.2 Tunnel 2 side-opening doors flat glass

Set consists of:	Art.-Nr.	No.	Price
HKD 2.2 D/DF, single glazing		1	
Door frame or mounting frame		2	
Upper lining for HKD 2.2 Tunnel		1	
Inner lining set for HKD 2.2 Tunnel		1	
Support bearing HKD 2.2		1	



Additional options (for all smoke hood variants)			
EAS (see page 116)			2218,50
Reduced price for EAS without display			-192,50
Double glazing			416,00
Door lock as revision handle			91,00
Door handle black	02056-01		117,00

Smoke hood variants:



+ Cast iron dome ø 180 mm	D009363	1	
Front variants:			
Door frame, black		SET208468	6263,50
Door frame, stainless steel		SET208469	6383,00
Mounting frame, black		SET208470	6526,00
Mounting frame, stainless steel		SET208471	6812,00







+ Cast iron cover ø 180 mm and cast iron heat exchanger rings	R015006-02	2	
Front variants:			
Door frame, black		SET213335	7625,00
Door frame, stainless steel		SET213336	7745,00
Mounting frame, black		SET213337	7888,00
Mounting frame, stainless steel		SET213338	8174,00
Alternative article: connection piece eccentric instead of cast iron dome			
Connection piece eccentric ø 180 mm		S003024	-184,50
Connection piece eccentric ø 200 mm		S003025	-184,50
Additional options			
90° bend - dumper flap and cleaning ø 180 mm	S002198		274,50
90° bend - dumper flap and cleaning ø 200 mm	S002208		295,00



+ Cast iron dome ø 180 mm low	D003664	1	
Front variants:			
Door frame, black		SET212888	6533,00
Door frame, stainless steel		SET212889	6653,00
Mounting frame, black		SET212890	6796,00
Mounting frame, stainless steel		SET212891	7082,00



+ Modular accumulator MAS 440 double-layered		R009042	5	
Cast iron dome MAS ø 180		R009095-01	1	
Mounting ring		10077	1	
Front variants:				
Door frame, black		SET212832		8018,50
Door frame, stainless steel		SET212833		8138,00
Mounting frame, black		SET212834		8281,00
Mounting frame, stainless steel		SET212835		8567,00
Additional option MAS				
Exchange connectiong piece ø 200 mm		R009105		75,50
Exchange connectiong pieceø 160 mm		07137		75,50

Energy efficiency index A +

flat

Tunnel

round

Eck

Tiled stoves



HKD 2.2 XL Tunnel 2 side-opening doors flat glass

Set consists of:	Art.-Nr.	No.	Price
HKD 2.2 XL D/D F, single glazing		1	
Door frame or mounting frame		2	
Inner lining set for HKD 2.2 XL Tunnel		1	
Upper lining for HKD 2.2 XL		1	
Support bearing HKD 2.2 XL		1	

Additional options			
EAS (see page 116)			2218,50
Reduced price for EAS without display			-192,50
Double glazing			416,00
Door lock as revision handle			91,00
Door handle black	02056-01		117,00

Smoke hood variants:



+ Cast iron dome ø 180 mm		D009363	1	
Front variants:				
Door frame, black		SET208224		6923,00
Door frame, stainless steel		SET208225		7043,00
Mounting frame, black		SET208226		7186,00
Mounting frame, stainless steel		SET208227		7472,00



+ Cast iron dome ø 180 mm, low		D003664	1	
Front variants:				
Door frame, black		SET212904		7193,00
Door frame, stainless steel		SET212905		7312,50
Mounting frame, black		SET212906		7455,50
Mounting frame, stainless steel		SET212907		7741,50

Energy efficiency index A +

HKD 2.2 Tunnel 2 side-opening doors round



Set consists of:	Art.-Nr.	No.	Price
HKD 2.2 D/D R, single glazing		1	
Door frame or mounting frame		2	
Upper lining for HKD 2.2 Tunnel		1	
Inner lining set for HKD 2.2 Tunnel		1	
Support bearing HKD 2.2		1	

Additional options (for all smoke hood variants)			
EAS (see page 116)			2218,50
Reduced price for EAS without display			-192,50
Door lock as revision handle			91,00
Door handle black	02056-01		117,00

Smoke hood variants:



+ Cast iron dome ø 180 mm		D009363	1	
Front variants:				
Door frame, black R = 380		SET208489		7315,00
Mounting frame, black R = 330		SET208491		7315,00





+ Cast iron cover ø 180 mm and cast iron heat exchanger rings		R015006-02	2	
Front variants:				
Door frame, black R = 380		SET213339		8677,00
Mounting frame, black R = 330		SET213340		8677,00
Alternative article: connection piece eccentric instead of cast iron dome				
Connection piece eccentric ø 180 mm		S003024		-184,50
Connection piece eccentric ø 200 mm		S003025		-184,50
Additional options				
90° bend - dumper flap and cleaning ø 180 mm		S002198		274,50
90° bend - dumper flap and cleaning ø 200 mm		S002208		295,00



+ Cast iron dome ø 180 mm low		D003664	1	
Front variants:				
Door frame, black R = 380		SET212866		7585,00
Mounting frame, black R = 330		SET212868		7585,00



+ Modular accumulator MAS 440 double-layered	R009042	5	
Cast iron dome MAS ø 180	R009095-01	1	
Mounting ring	10077	1	
Front variants:			
Door frame, black R = 380	 SET212854		9070,00
Mounting frame, black R = 330	 SET212856		9070,00
Additional option MAS			
Exchange connectiong piece ø 200 mm	R009105		75,50
Exchange connectiong pieceø 160 mm	07137		75,50

Energy efficiency index A +





HKD 2.2 XL Tunnel 2 side-opening doors round

Set consists of:	Art.-Nr.	No.	Price
HKD 2.2 XL D/D R, single glazing		1	
Door frame or mounting frame		2	
Inner lining set for HKD 2.2 XL Tunnel		1	
Upper lining for HKD 2.2 XL		1	
Support bearing HKD 2.2 XL		1	



Additional options			
EAS (see page 116)			2218,50
Reduced price for EAS without display			-192,50
Door lock as revision handle			91,00
Door handle black	02056-01		117,00

Smoke hood variants:



+ Cast iron dome ø 180 mm		D009363	1	
Front variants:				
Door frame R = 380, black		SET208243		7909,00
Mounting frame R = 330, black		SET208245		7909,00



+ Cast iron dome ø 180 mm, low		D003664	1	
Door frame R = 380, black		SET212909		8179,00
Mounting frame R = 330, black		SET212911		8179,00

Energy efficiency index A +





HKD 7 Tunnel side-opening door/side-opening door flat glass

Set consists of:	Art.-Nr.	No.	Price
HKD 7 D/D F , single glazing		1	
Mounting frame		2	
Inner lining set for HKD 7 Tunnel		1	
Support bearing HKD 7		1	



Additional options (for all smoke hood variants)			
EAS (see page 116)			2218,50
Reduced price for EAS without display			-192,50
Double glazing			416,00
Revision handle	02429		91,00
Door hinge self-closing	D030134		84,50
Door handle black	02056-01		117,00

Smoke hood variants:



+ Cast iron dome ø 180 mm	D004186	1	
Front variants:			
Mounting frame, black		SET212698	7965,00
Door frame, black		SET212735	8001,50
Additional option for cast iron dome			
Cast iron hood ø 200 mm	10087		0,00





Cast iron cover ø 180 mm and cast iron heat exchanger rings	R015006-02	2	
Front variants			
Mounting frame, black		SET213237	9383,50
Door frame, black		SET213238	9420,00
Alternative article: connection piece eccentric instead of cast iron dome			
Connection piece eccentric ø 180 mm		S003024	-184,50
Connection piece eccentric ø 200 mm		S003025	-184,50
Additional options			
90° bend - dumper flap and cleaning ø 180 mm	S002198		274,50
90° bend - dumper flap and cleaning ø 200 mm	S002208		295,00



+ Cast iron dome ø 180 mm low	D016042	1	
Front variants:			
Mounting frame, black		SET212709	8291,50
Door frame, black		SET212736	8328,00



+ Modular accumulator MAS 440 double-layered		R009042	7	
Cast iron dome MAS ø 180		R009095-01	1	
Mounting ring		10077	1	
Front variants:				
Mounting frame, black		SET212700		10335,50
Door frame, black		SET212737		10372,00
Additional option MAS				
Exchange connectiong piece ø 200 mm		R009105		75,50
Exchange connectiong pieceø 160 mm		07137		75,50

Energy efficiency index A +



HKD 8 Tunnel side-opening door/side-opening door flat glass

Set consists of:	Art.-Nr.	No.	Price
HKD 8 D/D F, single glazing		1	
Inner lining set for HKD 8 Tunnel		1	
Support bearing HKD 8		1	

Additional options (for all smoke hood variants)			
EAS (see page 116)			2218,50
Reduced price for EAS without display			-192,50
Double glazing			416,00
Construction plates for door frame HKD 8	SET212720		216,00
Attention: The choice of door variant (left or right closing doors) and the EOS/EAS option must be already made when placing the order. Later modifications are not possible anymore! Selfclosing doors are not available!			

Smoke hood variants:



+ Cast iron dome ø 180 mm	D004186	1	
Front variants:			
Mounting bracket, black	 SET212703		8950,00
Door frame, black	 SET212743		10217,50
Additional option for cast iron dome			
Cast iron hood ø 200 mm	10087		0,00





+ Cast iron cover ø 180 mm and cast iron heat exchanger rings	R015006-02	2	
Front variants			
Mounting bracket, black	 SET213239		10368,00
Door frame, black	 SET213240		11635,50
Alternative article: connection piece eccentric instead of cast iron dome			
Connection piece eccentric ø 180 mm	 S003024		-184,50
Connection piece eccentric ø 200 mm	S003025		-184,50
Additional options			
90° bend - dumper flap and cleaning ø 180 mm	S002198		274,50
90° bend - dumper flap and cleaning ø 200 mm	S002208		295,00



+ Cast iron dome ø 180 mm low	D016042	1	
Front variants:			
Mounting bracket, black	 SET212711		9276,00
Door frame, black	 SET212744		10543,50



+ Modular accumulator MAS 440 double-layered		R009042	7	
Cast iron dome MAS ø 180		R009095-01	1	
Mounting ring		10077	1	
Front variants:				
Mounting bracket, black		SET212704		11320,50
Door frame, black		SET212745		12588,00
Additional option MAS				
Exchange connectiong piece ø 200 mm		R009105		75,50
Exchange connectiong pieceø 160 mm		07137		75,50

Energy efficiency index A +

flat

Tiled stoves

Tunnel

round

Eck



HKD 13 Tunnel side-opening door/side-opening door flat glass

Set consists of:	Art.-Nr.	No.	Price
HKD 13 D/D F, single glazing		1	
Mounting frame / Door frame		2	
Inner lining set for HKD 13 Tunnel		1	
Support bearing HKD 13		1	



Additional options (for all smoke hood variants)			
EAS (see page 116)			2218,50
Reduced price for EAS without display			-192,50
Glass ceramic coated (GKB)			284,50
Revision handle	02429		91,00
Door handle black	02056-01		117,00
Door hinge self-closing	D030134		84,50
Catalyst module BKH 5.0 / HKD 13	HK000210		1132,50

Smoke hood variants:





+ Cast iron dome ø 180 mm	D004186	1	
Front variants:			
Mounting frame, black		SET213257	8794,50
Door frame, black		SET213258	8822,00
Additional option for cast iron dome			
Cast iron hood ø 200 mm	10087		0,00





Cast iron cover ø 180 mm and cast iron heat exchanger rings	R015006-02	2	
Front variants			
Mounting frame, black		SET213259	10213,00
Door frame, black		SET213260	10240,00
Alternative article: connection piece eccentric instead of cast iron dome			
Connection piece eccentric ø 180 mm		S003024	-184,50
Connection piece eccentric ø 200 mm	S003025		-184,50
Additional options			
90° bend - dumper flap and cleaning ø 180 mm	S002198		274,50
90° bend - dumper flap and cleaning ø 200 mm	S002208		295,00



+ Cast iron dome ø 180 mm low	D016042	1	
Front variants:			
Mounting frame, black		SET213261	9121,00
Door frame, black		SET213262	9148,00



+ Modular accumulator MAS 440 double-layered		R009042	7	
Cast iron dome MAS ø 180		R009095-01	1	
Mounting ring		10077	1	
Front variants:				
Mounting frame, black		SET213263		11165,00
Door frame, black		SET213264		11192,50
Additional option MAS				
Exchange connectiong piece ø 200 mm		R009105		75,50
Exchange connectiong pieceø 160 mm		07137		75,50

Energy efficiency index A +



DHT middle



HKD 2.2 side-opening door round

Set consists of:	Art.-Nr.	No.	Price
HKD 2.2 DR , single glazing		1	
Door frame or mounting frame		1	
Upper lining for HKD 2.2		1	
Inner lining set for HKD 2.2		1	
Support bearing HKD 2.2		1	

Additional options (for all smoke hood variants)			
EAS (see page 116)			2030,00
Reduced price for EAS without display			-192,50
Additional door DHT middle			1514,50
EAS at DHT			2218,50
Revision handle	02429		91,00
Door handle black	02056-01		117,00

Smoke hood variants:



+ Cast iron dome ø 180 mm	D009363	1	
Front variants:			
Door frame, black R = 380		SET208484	5620,00
Mounting frame, black R = 330		SET208486	5620,00





+ Cast iron cover ø 180 mm and cast iron heat exchanger rings	R015006-02	2	
Front variants:			
Door frame, black R = 380		SET213341	6981,50
Mounting frame, black R = 330		SET213342	6981,50
Alternative article: connection piece eccentric instead of cast iron dome			
Connection piece eccentric ø 180 mm		S003024	-184,50
Connection piece eccentric ø 200 mm		S003025	-184,50
Additional options			
90° bend - dumper flap and cleaning ø 180 mm	S002198		274,50
90° bend - dumper flap and cleaning ø 200 mm	S002208		295,00



+ Cast iron dome ø 180 mm low	D003664	1	
Front variants			
Door frame, black R = 380		SET212862	5889,50
Mounting frame, black R = 330		SET212864	5889,50



+ Modular accumulator MAS 440 double-layered		R009042	5	
Cast iron dome MAS ø 180		R009095-01	1	
Mounting ring		10077	1	
Front variants:				
Door frame, black R = 380		SET212850		7375,00
Mounting frame, black R = 330		SET212852		7375,00
Additional option MAS				
Exchange connectiong piece ø 200 mm		R009105		75,50
Exchange connectiong pieceø 160 mm		07137		75,50

Energy efficiency index A +





HKD 2.2 k side-opening door round

Set consists of:	Art.-Nr.	No.	Price
HKD 2.2 k DR , single glazing		1	
Door frame or mounting frame		1	
Inner lining set for HKD 2.2 k		1	
Upper lining for HKD 2.2 k		1	
Support bearing HKD 2.2 k		1	

Additional options			
EAS (see page 116)			2030,00
Reduced price for EAS without display			-192,50
Door handle black	02056-01		117,00
MAS (see page 346)			

Available variants:

Front variants:			
Door frame R = 380, black		SET208509	5529,50
Mounting frame R = 330, black		SET208511	5529,50

Energy efficiency index A +



DHT middle





HKD 2.2 XL side-opening door round

Set consists of:	Art.-Nr.	No.	Price
HKD 2.2 XL DR, single glazing		1	
Door frame or mounting frame		1	
Inner lining set for HKD 2.2 XL		1	
Upper lining for HKD 2.2 XL		1	
Support bearing HKD 2.2 XL		1	



Additional options (for all smoke hood variants)			
EAS (see page 116)			2030,00
Reduced price for EAS without display			-192,50
Additional door DHT middle			1514,50
EAS at DHT			2218,50
Revision handle	02429		91,00
Door handle black	02056-01		117,00

Smoke hood variants:



+ Cast iron dome ø 180 mm		D009363	1	
Front variants:				
Door frame R = 380, black		SET208239		6310,00
Mounting frame R = 330, black		SET208241		6310,00



+ Cast iron dome ø 180 mm low		D003664	1	
Front variants:				
Door frame R = 380, black		SET212900		6580,00
Mounting frame R = 330, black		SET212902		6580,00

Energy efficiency index A +



HKD 11 Eck side-opening door left side

Set consists of:	Art.-Nr.	No.	Price
HKD 11 Eck DTL , single glazing two-piece ceramic glass		1	
Door frame or mounting frame		1	
Inner lining set for HKD 11		1	



Additional options (for all smoke hood variants)			
EAS (see page 116)			2030,00
Reduced price for EAS without display			-192,50

Smoke hood variants:



+ Cast iron dome ø 180 mm	D004186	1	
Front variants:			
Mounting frame, black		SET213070	6836,00
Door frame, black		SET213071	6929,00
Additional option for cast iron dome			
Cast iron hood ø 200 mm	10087		0,00





+ Cast iron cover ø 180 mm and cast iron heat exchanger rings	R015006-02	2	
Front variants			
Mounting frame, black		SET213241	8254,50
Door frame, black		SET213242	8347,50
Alternative article: connection piece eccentric instead of cast iron dome			
Connection piece eccentric ø 180 mm		S003024	-184,50
Connection piece eccentric ø 200 mm	S003025		-184,50
Additional options			
90° bend - dumper flap and cleaning ø 180 mm	S002198		274,50
90° bend - dumper flap and cleaning ø 200 mm	S002208		295,00



+ Cast iron dome ø 180 mm low	D016042	1	
Front variants:			
Mounting frame, black		SET213072	7162,50
Door frame, black		SET213073	7255,50



+ Modular accumulator MAS 440 double-layered	R009042	7	
Cast iron dome MAS ø 180	R009095-01	1	
Mounting ring	10077	1	
Front variants:			
Mounting frame, black		SET213074	9206,50
Door frame, black		SET213075	9299,50
Additional option MAS			
Exchange connectiong piece ø 200 mm	R009105		75,50
Exchange connectiong piece ø 160 mm	07137		75,50

Energy efficiency index A +

HKD 11 Eck side-opening door right side



Set consists of:	Art.-Nr.	No.	Price
HKD 11 Eck DTR , single glazing two-piece ceramic glass		1	
Door frame or mounting frame		1	
Inner lining set for HKD 11		1	



Additional options (for all smoke hood variants)			
EAS (see page 116)			2030,00
Reduced price for EAS without display			-192,50

Smoke hood variants:





+ Cast iron dome ø 180 mm	D004186	1	
Front variants:			
Mounting frame, black		SET213076	6836,00
Door frame, black		SET213077	6929,00
Additional option for cast iron dome			
Cast iron hood ø 200 mm	10087		0,00





+ Cast iron cover ø 180 mm and cast iron heat exchanger rings	R015006-02	2	
Front variants			
Mounting frame, black		SET213243	8254,50
Door frame, black		SET213244	8347,50
Alternative article: connection piece eccentric instead of cast iron dome			
Connection piece eccentric ø 180 mm		S003024	-184,50
Connection piece eccentric ø 200 mm		S003025	-184,50
Additional options			
90° bend - dumper flap and cleaning ø 180 mm	S002198		274,50
90° bend - dumper flap and cleaning ø 200 mm	S002208		295,00



+ Cast iron dome ø 180 mm low	D016042	1	
Front variants:			
Mounting frame, black		SET213078	7162,50
Door frame, black		SET213079	7255,50



+ Modular accumulator MAS 440 double-layered	R009042	7	
Cast iron dome MAS ø 180	R009095-01	1	
Mounting ring	10077	1	
Front variants:			
Mounting frame, black		SET213080	9206,50
Door frame, black		SET213081	9299,50
Additional option MAS			
Exchange connection piece ø 200 mm	R009105		75,50
Exchange connection piece ø 160 mm	07137		75,50

Energy efficiency index A +

Flat

Tunnel

round

Eck

Tiled stoves



HKD 12 ECK door hinge left side

Set consists of:	Art.-Nr.	No.	Price
HKD 12 ECK door hinge left side , single glazing two-piece ceramic glass		1	
Door frame or mounting frame		1	
Combustion chamber lining HKD 12		1	

Additional options (for all smoke hood variants)

EAS (see page 116)			2030,00
Reduced price for EAS without display			-192,50

Attention:



The door variant (right- or left-closing door) must be chosen already when ordering.
Future modification is not possible !

Smoke hood variants:





+ Cast iron dome ø 180 mm	D004186	1	
Front variants:			
Mounting frame, black	 SET213132		6157,00
Door frame, black	 SET213133		6189,50
Additional option for cast iron dome			
Cast iron hood ø 200 mm	10087		0,00





+ Cast iron cover ø 180 mm and cast iron heat exchanger rings	R015006-02	2	
Front variants			
Mounting frame, black	 SET213245		7575,00
Door frame, black	 SET213246		7607,50
Alternative article: connection piece eccentric instead of cast iron dome			
Connection piece eccentric ø 180 mm	 S003024		-184,50
Connection piece eccentric ø 200 mm	S003025		-184,50
Additional options			
90° bend - dumper flap and cleaning ø 180 mm	S002198		274,50
90° bend - dumper flap and cleaning ø 200 mm	S002208		295,00



+ Cast iron dome ø 180 mm low	D016042	1	
Front variants:			
Mounting frame, black	 SET213134		6483,00
Door frame, black	 SET213135		6515,50



+ Modular accumulator MAS 440 double-layered		R009042	5	
Cast iron dome MAS ø 180		R009095-01	1	
Mounting ring		10077	1	
Front variants:				
Mounting frame, black		SET213136		7968,50
Door frame, black		SET213137		8001,00
Additional option MAS				
Exchange connectiong piece ø 200 mm		R009105		75,50
Exchange connectiong pieceø 160 mm		07137		75,50

Energy efficiency index A +



HKD 12 Eck door hinge right side

Set consists of:	Art.-Nr.	No.	Price
HKD 12 Eck door hinge right side , single glazing two-piece ceramic glass		1	
Door frame or mounting frame		1	
Combustion chamber lining HKD 12		1	

Additional options (for all smoke hood variants)

EAS (see page 116)			2030,00
Reduced price for EAS without display			-192,50

Attention:



The door variant (right- or left-closing door) must be chosen already when ordering.
Future modification is not possible !

Smoke hood variants:



+ Cast iron dome ø 180 mm	D004186	1	
Front variants:			
Mounting frame, black		SET213082	6157,00
Door frame, black		SET213083	6189,50
Additional option for cast iron dome			
Cast iron hood ø 200 mm	10087		0,00





+ Cast iron cover ø 180 mm and cast iron heat exchanger rings	R015006-02	2	
Front variants			
Mounting frame, black		SET213247	7575,00
Door frame, black		SET213248	7607,50
Alternative article: connection piece eccentric instead of cast iron dome			
Connection piece eccentric ø 180 mm		S003024	-184,50
Connection piece eccentric ø 200 mm		S003025	-184,50
Additional options			
90° bend - dumper flap and cleaning ø 180 mm	S002198		274,50
90° bend - dumper flap and cleaning ø 200 mm	S002208		295,00



+ Cast iron dome ø 180 mm low	D016042	1	
Front variants:			
Mounting frame, black		SET213084	6483,00
Door frame, black		SET213085	6515,50



+ Modular accumulator MAS 440 double-layered		R009042	5	
Cast iron dome MAS ø 180		R009095-01	1	
Mounting ring		10077	1	
Front variants:				
Mounting frame, black		SET213086		7968,50
Door frame, black		SET213087		8001,00
Additional option MAS				
Exchange connectiong piece ø 200 mm		R009105		75,50
Exchange connectiong pieceø 160 mm		07137		75,50

Energy efficiency index A +

Warm air grating

	Art.-Nr.	Designation	Retail price
Warm air grating for Front plate size 48/83			
	10444	Warm air grating HKD 4/5 black Auslaufartikel	568,00
	10428	Warm air grating München (HKD 4/5)	393,50
Warm air grating for Front plate size 42/79			
	10442S	Warm air grating HKD 6 black Auslaufartikel	466,50
	10437	Warm air grating suitable to Cast iron front plate HKD 6.1	337,50
Warm air grating			
	10420	Air gratings Wien	393,50
	10410	Air gratings Passau	393,50
Warm air grating with warming tube			
	10123	Air gratings Wien with warming tube	585,50
	10125	Air gratings Passau with warming tube	585,50

Art.-Nr. black painted	Designation	warmkeeping compartment	width B	height H	clearance height C	clearance width D	mounting width E	mounting height F	depth mounting frame T	free section A
10428	Cast iron front plate 48/83		480	230	178	414	433	206	30	195
10444	Steel black front plate 48/83		480	230	187	438	455	198	48-60	243
10437	Cast iron front plate 42/79		420	220	170	370	398	196	30	150
10442S	Steel black front plate 42/79		420	230	188	378	394	196	40	193
10420	Wien	10123	450	230	165	364	420	206	30	195
10410	Passau	10125	450	230	180	414	435	206	30	210
10457	Plasterwork grille		220	70			208	59		70

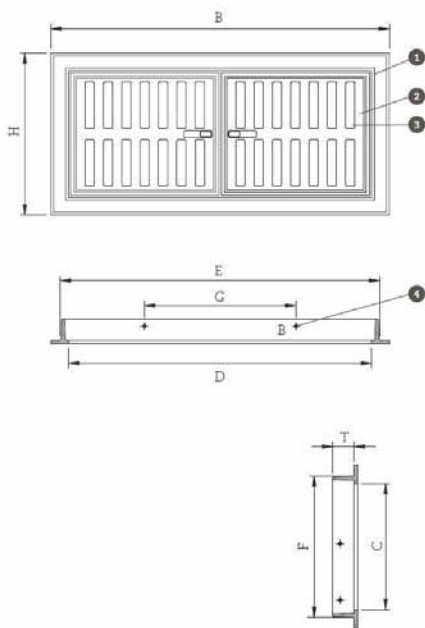

Warm air grating

- 1 grille frame
- 2 Grid door
- 3 sliding grille
- 4 fastening plate, storage tray, mounting bracket

Glazing formats

Flat glazing

from
page
172

Cast iron



Door dimensions height x width in cm

Steel

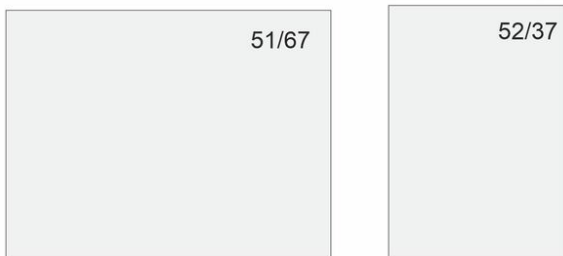

Door dimensions height x width in cm

Tunnel formats

from
page
182



Door dimensions height x width in cm

Eck corners

from
page
184

Steel

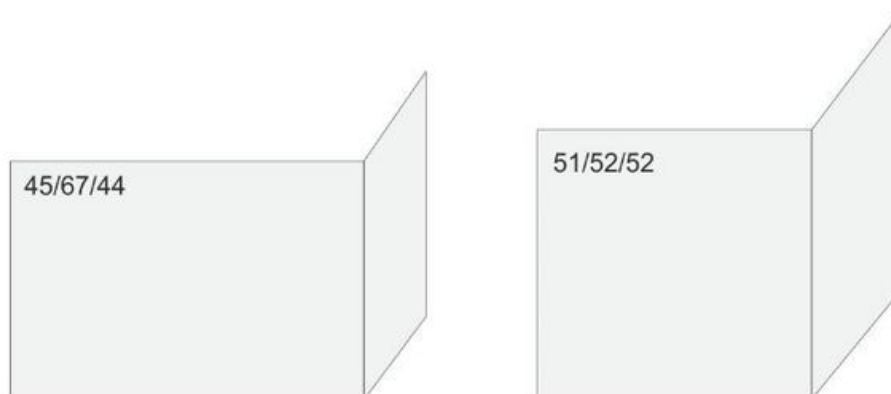

Door dimensions height x width x width in cm

Masonry heater doors

Door frame - mounting frame

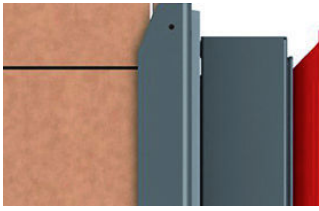

Door frame

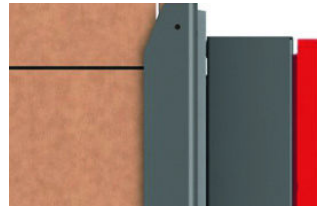

Mounting frame

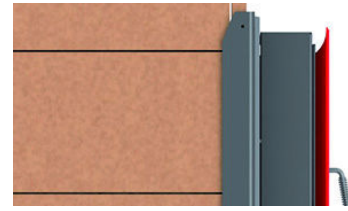

Cast iron frame

Supplementary equipment

- EAS** Combustion controls with potential-free relay (without additional functions) consisting of display, 1 x flush-mount box, door switch, thermocouple & bus line, each 2 m long. Preassembled EAS/EOS components, door switch, thermocouple, motor box with transmission and \varnothing 125 mm air flap, flexible hose with adjustable clamps
- EOS** Combustion control with graphic touchscreen display and additional functions (differential temperature control, Moritz's flap control) consisting of: Display with control unit, 2 x flush-mount box, door switch, thermocouple, bus and connecting line, each 2 m long, 4 x water sensors with immersion sleeve and 2x extension cable 3 m. Preassembled EOS components: door switch, thermocouple, motor box with transmission and \varnothing 125 mm air flap, flexible hose with adjustable clamps



GOT HBO 10

Set consists of:	Art.-Nr.	No.	Price
Masonry heater doors HBO 10, with viewing glass		1	

Available variants:

Front variants:			
Masonry heater doors HBO 10, with viewing glass	10599		675,50

KFR 33



Set consists of:	Art.-Nr.	No.	Price
KFR 33	G033016-01	1	3505,00

Additional options			
EAS (see page 171)			2030,00
Reduced price for EAS without display			-192,50
Installation frame 2x2,5 tile -22cm	G032122		336,50
Mausi connecting piece ø 130 mm	S004036		307,50

Door-version:	Art.-Nr.	No.	Price
Cast iron door inlay	C011106	1	152,00
Cast iron door inlay	C011106m	1	90,50
Assembly at the factory			

Energy efficiency index A +



GOT HKD 6.1 single glazing

Set consists of:	Art.-Nr.	No.	Price
Masonry heater doors HKD 6.1, single glazing		1	
Door frame		1	
Mounting console		1	

Additional options			
EAS (see page 171)			2030,00
Reduced price for EAS without display			-192,50
Conversion kit LH door	900110		62,00
Double glazing			0,00

Available variants:

Front variants:			
Door frame, black		SET208687	2277,50
Door frame, stainless steel		SET208688	2355,00
Cast iron frame, black		SET208689	2295,00

GOT HKD 6.1 single glazing + GOF 37x37



Set consists of:	Art.-Nr.	No.	Price
Masonry heater doors HKD 6.1, single glazing		1	
Door frame		1	
GOF 37 x 37 with support frame		1	
Combustion chamber mortar FM 1300, bucket 10 kg		1	
Adhesive and plastering mortars Universal 600, 20 kg		1	
High temperature sealing paste cartridge 310 ml		2	

Additional options			
EAS (see page 171)			2030,00
Reduced price for EAS without display			-192,50
Conversion kit LH door	900110		62,00
Double glazing			0,00
MSS connecting block / GOF top cover	G013196		205,50
MSS connecting block / GOF side/back wall	G015107		161,00
Mausi connecting piece ø 180 mm	S004035		307,50

Available variants:

Front variants:			
Door frame, black		SET208622	4700,00
Door frame, stainless steel		SET208623	4777,50
Cast iron frame, black		SET208624	4717,50

Energy efficiency index A +



GOT HKD 6.1 cast iron doors

Set consists of:	Art.-Nr.	No.	Price
Masonry heater doors HKD 6.1, cast iron doors		1	
Door frame		1	
Mounting console		1	

Additional options			
EAS (see page 171)			2030,00
Reduced price for EAS without display			-192,50
Conversion kit LH door	900110		62,00

Available variants:

Front variants:			
Cast iron frame, black		SET208692	2295,00

GOT HKD 6.1 cast iron doors + GOF 37x37



Set consists of:	Art.-Nr.	No.	Price
Masonry heater doors HKD 6.1, cast iron doors		1	
Door frame		1	
GOF 37 x 37 with support frame		1	
Combustion chamber mortar FM 1300, bucket 10 kg		1	
Adhesive and plastering mortars Universal 600, 20 kg		1	
High temperature sealing paste cartridge 310 ml		2	

Additional options			
EAS (see page 171)			2030,00
Reduced price for EAS without display			-192,50
Conversion kit LH door	900110		62,00
MSS connecting block / GOF top cover	G013196		205,50
MSS connecting block / GOF side/back wall	G015107		161,00
Mausi connecting piece ø 180 mm	S004035		307,50

Available variants:

Front variants			
Cast iron frame, black		SET208654	4717,50

Energy efficiency index A +



GOT HKD 5.1/12 single glazing

Set consists of:	Art.-Nr.	No.	Price
Masonry heater doors HKD 5.1/12 , single glazing		1	
Door frame, mounting frame, or front plate		1	
Mounting console		1	

Additional options			
EAS (see page 171)			2030,00
Reduced price for EAS without display			-192,50
Conversion kit LH door	900110		62,00
Double glazing			0,00

Available variants:

Front variants:				
Door frame, black		SET208675		2473,50
Door frame, stainless steel		SET208676		2574,50
Mounting frame, black		SET208747		2525,50
Cast iron frame, black		SET208677		2503,00

GOT HKD 5.1/12 single glazing + GOF 37x37



Set consists of:	Art.-Nr.	No.	Price
Masonry heater doors HKD 5.1/12, single glazing		1	
Door frame, mounting frame, or front plate		1	
GOF 37 x 37 with support frame		1	
Combustion chamber mortar FM 1300, bucket 10 kg		1	
Adhesive and plastering mortars Universal 600, 20 kg		1	
High temperature sealing paste cartridge 310 ml		2	

Additional options			
EAS (see page 171)			2030,00
Reduced price for EAS without display			-192,50
Conversion kit LH door	900110		62,00
Double glazing			0,00
MSS connecting block / GOF top cover	G013196		205,50
MSS connecting block / GOF side/back wall	G015107		161,00
Mausi connecting piece ø 180 mm	S004035		307,50

Available variants:

Front variants:				
Door frame, black		SET208625		4896,00
Door frame, stainless steel		SET208626		4997,00
Mounting frame, black		SET208731		4948,00
Cast iron frame, black		SET208627		4925,50

Energy efficiency index A +



GOT HKD 5.1/12 cast iron doors

Set consists of:	Art.-Nr.	No.	Price
Masonry heater doors HKD 5.1/12, cast iron doors		1	
Door frame or mounting frame		1	
Mounting console		1	
Additional options			
EAS (see page 171)			2030,00
Reduced price for EAS without display			-192,50
Conversion kit LH door	900110		62,00

Available variants:

Front variants:			
Cast iron frame, black		SET208680	2503,00



GOT HKD 5.1/12 cast iron doors + GOF 37x37

Set consists of:	Art.-Nr.	No.	Price
Masonry heater doors HKD 5.1/12, cast iron doors		1	
Door frame or mounting frame		1	
GOF 37 x 37 with support frame		1	
Combustion chamber mortar FM 1300, bucket 10 kg		1	
Adhesive and plastering mortars Universal 600, 20 kg		1	
High temperature sealing paste cartridge 310 ml		2	
Additional options			
EAS (see page 171)			2030,00
Reduced price for EAS without display			-192,50
Conversion kit LH door	900110		62,00
MSS connecting block / GOF top cover	G013196		205,50
MSS connecting block / GOF side/back wall	G015107		161,00
Mausi connecting piece ø 180 mm	S004035		307,50

Available variants:

Front variants			
Door frame		SET208657	4925,50

Energy efficiency index A +



GOT HKD 5.1/20 single glazing

Set consists of:	Art.-Nr.	No.	Price
Masonry heater doors HKD 5.1/20, single glazing		1	
Door frame, mounting frame, or front plate		1	
Mounting console		1	

Additional options			
EAS (see page 171)			2030,00
Reduced price for EAS without display			-192,50
Conversion kit LH door	900110		62,00
Double glazing			0,00

Available variants:

Front variants:				
Door frame, black		SET208681		2473,50
Door frame, stainless steel		SET208682		2574,50
Mounting frame, black		SET208751		2525,50
Cast iron frame, black		SET208683		2503,00

GOT 44/55 flat double glazing

Set consists of:	Art.-Nr.	No.	Price
Masonry heater doors 44/55 flat, double glazing		1	
Door frame		1	
Mounting console		1	

Additional options			
EAS (see page 171)			2030,00
Reduced price for EAS without display			-192,50
Conversion kit LH door	900112		69,00

Available variants:

Front variants:				
Door frame, black		SET208693		2774,00



GOT 51/67-ZL side-opening door

Set consists of:	Art.-Nr.	No.	Price
GOT 51/67-ZL side-opening door , single glazing		1	
Door frame		1	

Additional options			
EAS (see page 171)			2030,00
Reduced price for EAS without display			-192,50
Conversion kit right hinge door	02380		173,00
Door bricks GOT 51/67-ZL	G015020		437,00
Air connecting piece ø 160 mm	I046109		68,50
Air connecting piece ø 125 mm	02333		37,50
Double glazing			375,50

Available variants:

Front variants:			
Door frame, black		SET208701	3458,00



GOT 51/67-ZL side-opening door + GOF 66x42

Set consists of:	Art.-Nr.	No.	Price
GOT 51/67-ZL side-opening door , single glazing		1	
Door frame		1	
GOF 66x42		1	
Combustion chamber mortar FM 1300, bucket 10 kg		1	
Adhesive and plastering mortars Universal 600, 20 kg		1	
High temperature sealing paste cartridge 310 ml		2	

Additional options			
EAS (see page 171)			2030,00
Reduced price for EAS without display			-192,50
Conversion kit right hinge door	02380		173,00
MSS connecting block / GOF top cover	G013196		205,50
MSS connecting block / GOF side/back wall	G015107		161,00
Double glazing			375,50
Mausi connecting piece ø 180 mm	S004035		307,50

Available variants:

Front variants:			
Door frame, black		SET208715	6701,50

Energy efficiency index A +



GOT 52/37-ZL side-opening door

Set consists of:	Art.-Nr.	No.	Price
GOT 52/37-ZL side-opening door, single glazing		1	
Door frame		1	

Additional options			
EAS (see page 171)			2030,00
Reduced price for EAS without display			-192,50
Door bricks GOT 52/37-ZL	G019077		334,00
Air connecting piece ø 160 mm	I046109		68,50
Air connecting piece ø 125 mm	02333		37,50
Double glazing			208,00

Available variants:

Front variants:			
Door frame, black		SET208697	2629,50

GOT 52/37-ZL side-opening door + GOF 37x42



Set consists of:	Art.-Nr.	No.	Price
GOT 52/37-ZL side-opening door, single glazing		1	
Door frame		1	
GOF 37x42		1	
Combustion chamber mortar FM 1300, bucket 10 kg		1	
Adhesive and plastering mortars Universal 600, 20 kg		1	
High temperature sealing paste cartridge 310 ml		2	

Additional options			
EAS (see page 171)			2030,00
Reduced price for EAS without display			-192,50
MSS connecting block / GOF top cover	G013196		205,50
MSS connecting block / GOF side/back wall	G015107		161,00
Double glazing			208,00
Mausi connecting piece ø 180 mm	S004035		307,50

Available variants:

Front variants:			
Door frame, black		SET208709	5315,50

Energy efficiency index A +



GOT 51/67-ZL 2 side-opening doors + GOF Tunnel 66x36

Set consists of:	Art.-Nr.	No.	Price
GOT 51/67-ZL side-opening door, single glazing		2	
Door frame		2	
GOF-Tunnel 66x36		1	
Combustion chamber mortar FM 1300, bucket 10 kg		1	
Adhesive and plastering mortars Universal 600, 20 kg		1	
High temperature sealing paste cartridge 310 ml		2	

Additional options			
EAS (see page 171)			2218,50
Reduced price for EAS without display			-192,50
Conversion kit right hinge door	02380		173,00
Door lock as revision handle	02426		169,00
MSS connecting block / GOF top cover	G017110		188,00
MSS connecting block / GOF side	G015108		161,00
Double glazing (also one side only available on request)			751,50
Mausi connecting piece ø 180 mm	S004035		307,50

Available variants:

Front variants:			
Door frame, black		SET210504	10289,00

Energy efficiency index A +

Flat

Tunnel

Eck



GOT 51/52/52-ZL side-opening door

Set consists of:	Art.-Nr.	No.	Price
GOT 51/52/52-ZL, single glazing two-piece ceramic glass		1	
Door frame		1	

Additional options			
EAS (see page 171)			2030,00
Reduced price for EAS without display			-192,50
Conversion kit right hinge door	02380		173,00
Door bricks GOT 51/52/52-ZL	G018032		437,00
Air connecting piece ø 160 mm	I046109		68,50
Air connecting piece ø 125 mm	02333		37,50

Available variants:

Front variants:			
Door frame, black		SET208707	4966,00

GOT 51/52/52-ZL side-opening door + GOF 35x35



Set consists of:	Art.-Nr.	No.	Price
GOT 51/52/52-ZL, single glazing two-piece ceramic glass		1	
Door frame		1	
GOF 35x35		1	
Combustion chamber mortar FM 1300, bucket 10 kg		1	
Adhesive and plastering mortars Universal 600, 20 kg		1	
High temperature sealing paste cartridge 310 ml		2	

Additional options			
EAS (see page 171)			2030,00
Reduced price for EAS without display			-192,50
Conversion kit right hinge door	02380		173,00
MSS connecting block / GOF top cover	G021138		188,00
MSS connecting block / GOF right side	G023205		161,00
MSS connecting block / GOF left side	G023204		161,00
Mausi connecting piece ø 180 mm	S004035		307,50

Available variants:

Front variants:			
Door frame, black		SET208719	7058,50

Energy efficiency index A +

GOT 45/67/44-ZL side-opening door L



Set consists of:	Art.-Nr.	No.	Price
GOT 45/67/44-ZL L , single glazing two-piece ceramic glass		1	
Door frame		1	

Additional options			
EAS (see page 171)			2030,00
Reduced price for EAS without display			-192,50
Door bricks GOT 45/67/44-ZL L	G025053		517,50
Air connecting piece \varnothing 160 mm	I046109		68,50
Air connecting piece \varnothing 125 mm	02333		37,50

Available variants:

Front variants:			
Door frame, black		SET210924	5474,50

GOT 45/67/44-ZL side-opening door L + GOF 50x35



Set consists of:	Art.-Nr.	No.	Price
GOT 45/67/44-ZL L , single glazing two-piece ceramic glass		1	
Door frame		1	
GOF-Tunnel 50x35		1	
Combustion chamber mortar FM 1300, bucket 10 kg		1	
Adhesive and plastering mortars Universal 600, 20 kg		1	
High temperature sealing paste cartridge 310 ml		2	

Additional options			
EAS (see page 171)			2030,00
Reduced price for EAS without display			-192,50
MSS connecting block / GOF top cover	G021138		188,00
MSS connecting block / GOF right side	G023205		161,00
MSS connecting block GOF backwall	G015107		161,00
Mausi connecting piece \varnothing 180 mm	S004035		307,50

Available variants:

Front variants:			
Door frame, black		SET210928	8316,00

Energy efficiency index A +



GOT 45/67/44-ZL lifting door L

Set consists of:	Art.-Nr.	No.	Price
GOT 45/67/44-ZL STL , single glazing two-piece ceramic glass		1	
Mounting frame		1	

Additional options			
EAS (see page 171)			2030,00
Reduced price for EAS without display			-192,50
Door bricks GOT 45/67/44-ZL L	G025053		517,50
Air connecting piece ø 160 mm	I046109		68,50
Air connecting piece ø 125 mm	O2333		37,50
Counterweights for non-self closing door	49097		60,50

Available variants:

Front variants:			
Mounting frame, black 50 mm		G025093-11	6062,00

GOT 45/67/44-ZL lifting door L + GOF 50x35



Set consists of:	Art.-Nr.	No.	Price
GOT 45/67/44-ZL STL , single glazing two-piece ceramic glass		1	
Mounting frame		1	
GOF 50x35		1	
Combustion chamber mortar FM 1300, bucket 10 kg		1	
Adhesive and plastering mortars Universal 600, 20 kg		1	
High temperature sealing paste cartridge 310 ml		2	

Additional options			
EAS (see page 171)			2030,00
Reduced price for EAS without display			-192,50
MSS connecting block / GOF top cover	G021138		188,00
MSS connecting block / GOF right side	G023205		161,00
MSS connecting block GOF backwall	G015107		161,00
Mausi connecting piece ø 180 mm	S004035		307,50
Counterweights for non-self closing door	49097		60,50

Available variants:

Front variants:			
Mounting frame, black 50 mm		G025094-11	8863,50

Energy efficiency index A +



GOT 45/67/44-ZL side-opening door R

Set consists of:	Art.-Nr.	No.	Price
GOT 45/67/44-ZL R , single glazing two-piece ceramic glass		1	
Door frame		1	

Additional options			
EAS (see page 171)			2030,00
Reduced price for EAS without display			-192,50
Door bricks GOT 45/67/44-ZL R	G025026		517,50
Air connecting piece ø 160 mm	I046109		68,50
Air connecting piece ø 125 mm	02333		37,50

Available variants:

Front variants:			
Door frame, black		set210922	5474,50



GOT 45/67/44-ZL side-opening door R + GOF 50x35

Set consists of:	Art.-Nr.	No.	Price
GOT 45/67/44-ZL R , single glazing two-piece ceramic glass		1	
Door frame		1	
GOF 50x35		1	
Combustion chamber mortar FM 1300, bucket 10 kg		1	
Adhesive and plastering mortars Universal 600, 20 kg		1	
High temperature sealing paste cartridge 310 ml		2	

Additional options			
EAS (see page 171)			2030,00
Reduced price for EAS without display			-192,50
MSS connecting block / GOF top cover	G021138		188,00
MSS connecting block / GOF left side	G023204		161,00
MSS connecting block GOF backwall	G015107		161,00
Mausi connecting piece ø 180 mm	S004035		307,50

Available variants:

Front variants:			
Door frame, black		SET210926	8316,00

Energy efficiency index A +



GOT 45/67/44-ZL lifting door R

Set consists of:	Art.-Nr.	No.	Price
GOT 45/67/44-ZL STR , single glazing two-piece ceramic glass		1	
Mounting frame		1	

Additional options			
EAS (see page 171)			2030,00
Reduced price for EAS without display			-192,50
Door bricks GOT 45/67/44-ZL R	G025026		517,50
Air connecting piece ø 160 mm	I046109		68,50
Air connecting piece ø 125 mm	O2333		37,50
Counterweights for non-self closing door	49097		60,50

Available variants:

Front variants:			
Mounting frame, black 50 mm		G025058-11	6062,00

GOT 45/67/44-ZL lifting door R + GOF 50x35



Set consists of:	Art.-Nr.	No.	Price
GOT 45/67/44-ZL STR , single glazing two-piece ceramic glass		1	
Mounting frame		1	
GOF 50x35		1	
Combustion chamber mortar FM 1300, bucket 10 kg		1	
Adhesive and plastering mortars Universal 600, 20 kg		1	
High temperature sealing paste cartridge 310 ml		2	

Additional options			
EAS (see page 171)			2030,00
Reduced price for EAS without display			-192,50
MSS connecting block / GOF top cover	G021138		188,00
MSS connecting block / GOF left side	G023204		161,00
MSS connecting block GOF backwall	G015107		161,00
Mausi connecting piece ø 180 mm	S004035		307,50
Counterweights for non-self closing door	49097		60,50

Available variants:

Front variants:			
Mounting frame, black 50 mm		G025088-11	8863,50

Energy efficiency index A +

Flat

Tunnel

Eck

Glazing formats

Flat glazing



KSO 33q

Door dimensions height x width in cm

from
page
192

Round glazing



KSO 33r

Door dimensions height x width in cm

from
page
194

Mounting frame- Accumulation stove



Mounting frame

Supplementary equipment

- EAS** Combustion controls with potential-free relay (without additional functions) consisting of display, 1 x flush-mount box, door switch, thermocouple & bus line, each 2 m long. Preassembled EAS/EOS components, door switch, thermocouple, motor box with transmission and \varnothing 125 mm air flap, flexible hose with adjustable clamps
- EOS** Combustion control with graphic touchscreen display and additional functions (differential temperature control, Moritz's flap control) consisting of: Display with control unit, 2 x flush-mount box, door switch, thermocouple, bus and connecting line, each 2 m long, 4 x water sensors with immersion sleeve and 2x extension cable 3 m. Preassembled EOS components: door switch, thermocouple, motor box with transmission and \varnothing 125 mm air flap, flexible hose with adjustable clamps



KSO 33q, with thermal concrete cladding

Set consists of:	Art.-Nr.	No.	Price
Accumulation stove KSO 33q , horizontal outlet		1	
Firebox KSO 33 ø 540 mm		1	
Top-mount accumulator KSO 33 ø 540 mm		1	
Front with doors (44 x 33), flat glass		1	
KSO 33 Firebox support frame		1	
High temperature sealing paste		1	
Mounting frame according table		1	
Smoke pipe connection ø 130 mm, horizontal		1	
Cover for smoke pipe connecting piece ø 130 mm, horizontal		1	
Thermal concrete cladding		1	

Additional options

Conversion kit for vertical outlet instead of horizontal smoke pipe connection (G022158) a vertical smoke pipe connection (G020405) is delivered			0,00
Conversion kit LH door	900110		62,00

Available variants:

Front variants			
Mounting frame, black		SET211386	8247,00

Energy efficiency index A +

KSO 33q, with thermal concrete cladding + EAS



Set consists of:	Art.-Nr.	No.	Price
Accumulation stove KSO 33q, horizontal outlet		1	
Firebox KSO 33 ø 540 mm		1	
Top-mount accumulator KSO 33 ø 540 mm		1	
Front with doors (44 x 33), flat glass		1	
KSO 33 Firebox support frame		1	
High temperature sealing paste		1	
Mounting frame according table		1	
Smoke pipe connection ø 130 mm, horizontal		1	
Cover for smoke pipe connecting piece ø 130 mm, horizontal		1	
Thermal concrete cladding		1	
EAS (see page 191)		1	
Mounting box		1	
Door switch wiring 3 lm		1	
Thermocouple wiring 3 lm		1	
Bus wiring 3 lm		1	

Additional options

Conversion kit for vertical outlet instead of horizontal smoke pipe connection (G022158) a vertical smoke pipe connection (G020405) is delivered			0,00
Conversion kit LH door	900110		62,00
Reduced price for EAS without display			-192,50

Available variants:

Front variants			
Mounting frame, black		SET211388	10310,50

Energy efficiency index A +



KSO 33r, with thermal concrete cladding

Set consists of:	Art.-Nr.	No.	Price
Accumulation stove KSO 33r , horizontal outlet		1	
Firebox KSO 33 ø 540 mm		1	
Top-mount accumulator KSO 33 ø 540 mm		1	
Front with doors (44 x 33), round glass		1	
KSO 33 Firebox support frame		1	
High temperature sealing paste		1	
Mounting frame according table		1	
Smoke pipe connection ø 130 mm, horizontal		1	
Cover for smoke pipe connecting piece ø 130 mm, horizontal		1	
Thermal concrete cladding		1	

Additional options

Conversion kit for vertical outlet instead of horizontal smoke pipe connection (G022158) a vertical smoke pipe connection (G020405) is delivered instead cover for horizontal smoke pipe connection (G020416) delivery contains a vertical smoke pipe con- nection (G020418)			0,00
Conversion kit LH door	900110		62,00

Available variants:

Front variants			
Mounting frame, black, 330 mm		SET211394	8137,50

Energy efficiency index A +

KSO 33r, with thermal concrete cladding + EAS



Set consists of:	Art.-Nr.	No.	Price
Accumulation stove KSO 33r , horizontal outlet		1	
Firebox KSO 33 ø 540 mm		1	
Top-mount accumulator KSO 33 ø 540 mm		1	
Front with doors (44 x 33), round glass		1	
KSO 33 Firebox support frame		1	
High temperature sealing paste		1	
Mounting frame according table		1	
Smoke pipe connection ø 130 mm, horizontal		1	
Cover for smoke pipe connecting piece ø 130 mm, horizontal		1	
Thermal concrete cladding		1	
EAS (see page 191)		1	
Mounting box		1	
Door switch wiring 3 lm		1	
Thermocouple wiring 3 lm		1	
Bus wiring 3 lm		1	

Additional options

Conversion kit for vertical outlet instead of horizontal smoke pipe connection (G022158) a vertical smoke pipe connection (G020405) is delivered instead cover for horizontal smoke pipe connection (G020416) delivery contains a vertical smoke pipe connection (G020418)			0,00
Conversion kit LH door	900110		62,00
Reduced price for EAS without display			-192,50

Available variants:

Front variants			
Mounting frame, black, 330 mm		SET211396	10200,50

Energy efficiency index A +

Glazing formats

Flat glazing



BSO 02, 03, 04, 06
Door dimensions height x width in cm



BSO 05

from
page
198

Tunnel formats



BSO 02, 03, 06
Door dimensions height x width in cm



BSO 05

from
page
208

Round glazing



BSO 1
Door dimensions height x width in cm

from
page
216

Mounting frame- System stoves



Mounting frame

Supplementary equipment

- EAS** Combustion controls with potential-free relay (without additional functions) consisting of display, 1 x flush-mount box, door switch, thermocouple & bus line, each 2 m long. Preassembled EAS/EOS components, door switch, thermocouple, motor box with transmission and \varnothing 125 mm air flap, flexible hose with adjustable clamps
- EOS** Combustion control with graphic touchscreen display and additional functions (differential temperature control, Moritz's flap control) consisting of: Display with control unit, 2 x flush-mount box, door switch, thermocouple, bus and connecting line, each 2 m long, 4 x water sensors with immersion sleeve and 2x extension cable 3 m. Preassembled EOS components: door switch, thermocouple, motor box with transmission and \varnothing 125 mm air flap, flexible hose with adjustable clamps



BSO 02

Set consists of:	Art.-Nr.	No.	Price
HKD 2.2, side-opening door, single glazed		1	
Chamotte lining set HKD 2.2		1	
Upper lining HKD 2.2		1	
Mounting frame		1	
Modular top-mount accumulator		5	
Cast iron dome MAS ø 180 horizontal/ vertical		1	
Mounting ring for modular top-mount storage		1	
Thermal concrete cladding BSO 02		1	

Additional options

Additional ring (top ring 1), raised cladding for BSO 02 (326 mm) *	BSO2000-006		296,50
* Differences of colour between the height extension ring and other components of BSK/BSO are due to manufacturing process and cannot be excluded. These colour differences are no reason for a claim.			
Double glazing			208,00
Heat protective panel BSO 02 (suitable for back wall or side wall)	BSO3000-034		108,00
Door handle black	02056-01		117,00

Available variants:

Front variants			
Mounting frame, black		SET211302	7687,00
Mounting frame, stainless steel		SET211303	7830,00

Energy efficiency index A +



BSO 02 + EAS

Set consists of:	Art.-Nr.	No.	Price
HKD 2.2, side-opening door, single glazed		1	
Chamotte lining set HKD 2.2		1	
Upper lining HKD 2.2		1	
Mounting frame		1	
Modular top-mount accumulator		5	
Cast iron dome MAS ø 180 horizontal/ vertical		1	
Mounting ring for modular top-mount storage		1	
Thermal concrete cladding BSO 02		1	
EAS (see page 191)		1	
Mounting box		1	
Door switch wiring 3 lm		1	
Thermocouple wiring 3 lm		1	
Bus wiring 3 lm		1	

Additional options			
Additional ring (top ring 1), raised cladding for BSO 02 (326 mm) *	BSO2000-006		296,50
* Differences of colour between the height extension ring and other components of BSK/BSO are due to manufacturing process and cannot be excluded. These colour differences are no reason for a claim.			
Double glazing			208,00
Heat protective panel BSO 02 (suitable for back wall or side wall)	BSO3000-034		108,00
Reduced price for EAS without display			-192,50
Air flap adapter ø 125 mm for direct assembly motor at device	N003156		31,00
Door handle black	02056-01		117,00

Available variants:

Front variants			
Mounting frame, black		SET211316	9750,00
Mounting frame, stainless steel		SET211317	9893,00

Energy efficiency index A +



BSO 03

Set consists of:	Art.-Nr.	No.	Price
HKD 2.2, side-opening door, single glazed		1	
Chamotte lining set HKD 2.2		1	
Upper lining HKD 2.2		1	
Mounting frame		1	
heat storage block BSO 03		1	
Segmental bend 45°		1	
Pipe conversion piece ø 180 mm, 90° assembly kit		1	
Thermal concrete cladding BSO 02		1	
Thermal concrete cladding heat storage block		1	

Additional options			
Additional ring (top ring 1); raised cladding for BSO 03 storage block (290 mm high) *	BSO3000-004		288,00
Additional ring (top ring 1), raised cladding for BSO 02 (326 mm) *	BSO2000-006		296,50
* Differences of colour between the height extension ring and other components of BSK/BSO are due to manufacturing process and cannot be excluded. These colour differences are no reason for a claim.			
Double glazing			208,00
Heat protective panel BSO 03 (suitable for side-wall/ Heat protective panel backwall included in delivery contents)	BSO3000-034		108,00
Door handle black	02056-01		117,00

Available variants:

Front variants			
Mounting frame, black		SET211308	10226,00
Mounting frame, stainless steel		SET211309	10369,00

Energy efficiency index A +

BSO 03 + EAS



Set consists of:	Art.-Nr.	No.	Price
HKD 2.2, side-opening door, single glazed		1	
Chamotte lining set HKD 2.2		1	
Upper lining HKD 2.2		1	
Mounting frame		1	
heat storage block BSO 03		1	
Segmental bend 45°		1	
Pipe conversion piece ø 180 mm, 90 ° assembly kit		1	
Thermal concrete cladding BSO 02		1	
Thermal concrete cladding heat storage block		1	
EAS (see page 191)		1	
Mounting box		1	
Door switch wiring 3 lm		1	
Thermocouple wiring 3 lm		1	
Bus wiring 3 lm		1	

Additional options

Additional ring (top ring 1) raised cladding for BSO 03 storage block (290 mm high) *	BSO3000-004		288,00
Additional ring (top ring 1); raised cladding for BSO 02 (326 mm) *	BSO2000-006		296,50
* Differences of colour between the height extension ring and other components of BSK/BSO are due to manufacturing process and cannot be excluded. These colour differences are no reason for a claim.			
Double glazing			208,00
Heat protective panel BSO 03 (suitable for side-wall/ Heat protective panel backwall included in delivery contents)	BSO3000-034		108,00
Reduced price for EAS without display			-192,50
Air flap adapter ø 125 mm for direct assembly motor at device	N003156		31,00
Door handle black	02056-01		117,00

Available variants:

Front variants			
Mounting frame, black		SET211322	12289,00
Mounting frame, stainless steel		SET211323	12432,00

Energy efficiency index A +



BSO 04

Set consists of:	Art.-Nr.	No.	Price
HKD 2.2 k SK, side-opening door, single glazed		1	
Chamotte lining set HKD 2.2 k SK		1	
Upper lining HKD 2.2 k SK		1	
Mounting frame		1	
Thermal concrete cladding BSO 04		1	

Additional options			
Additional ring (top ring 1), Raised cladding for BSO 04 (412 mm) *	BSO4000-006		489,50
* Differences of colour between the height extension ring and other components of BSK/BSO are due to manufacturing process and cannot be excluded. These colour differences are no reason for a claim.			
Double glazing			208,00
Set heat-protective panel	BSK12000-124		56,50
Door handle black	02056-01		117,00

Available variants:

Front variants			
Mounting frame, black		SET211470	8303,00
Mounting frame, stainless steel		SET211471	8446,00

Energy efficiency index A +

BSO 04 + EAS



Set consists of:	Art.-Nr.	No.	Price
HKD 2.2 k SK, side-opening door, single glazed		1	
Chamotte lining set HKD 2.2 k SK		1	
Upper lining HKD 2.2 k SK		1	
Mounting frame		1	
Thermal concrete cladding BSO 04		1	
EAS (see page 191)		1	
Mounting box		1	
Door switch wiring 2 lm		1	
Thermocouple wiring 2 lm		1	
Bus wiring 2 lm		1	

Additional options			
Reduced price for EAS without display			-192,50
Additional ring (top ring 1), Raised cladding for BSO 04 (412 mm) *	BSO4000-006		489,50
* Differences of colour between the height extension ring and other components of BSK/BSO are due to manufacturing process and cannot be excluded. These colour differences are no reason for a claim.			
Double glazing			208,00
Set heat-protective panel	BSK12000-124		56,50
Add. charge EOS ¹			1648,00
Air flap adapter ø 125 mm for direct assembly motor at device	N003156		31,00
Door handle black	02056-01		117,00

Available variants:

Front variants			
Mounting frame, black		SET211473	10333,00
Mounting frame, stainless steel		SET211474	10476,00

¹compared to EAS: EOS control & display unit, second flush-mount box, connecting cable for control & display unit 2m long, 4x water temperature sensor with sleeve and 2x extension cable 3m long.

Energy efficiency index A +



BSO 06 + EAS

Set consists of:	Art.-Nr.	No.	Price
HKD 2.2 SK, side-opening door, single glazed		1	
Chamotte lining set HKD 2.2 SK		1	
Upper lining HKD 2.2 SK		1	
Mounting frame		1	
Thermal concrete cladding BSO 06		1	
EAS (see page 191)		1	
Mounting box		1	
Door switch wiring 2 lm		1	
Thermocouple wiring 2 lm		1	
Bus wiring 2 lm		1	
Connecting piece for side/rear smoke outlet ø 180 mm		1	

Additional options

Reduced price for EAS without display			-192,50
Additional ring (top ring 1), Raising the BSO 06 (410 mm) *	BSO6000-006		377,00
* Differences of colour between the height extension ring and other components of BSK/BSO are due to manufacturing process and cannot be excluded. These colour differences are no reason for a claim.			
Double glazing			208,00
Set heat-protective panel	BSO6000-121		78,00
Smoke pipe outlet on top ø 180 mm	W043140		0,00
Conversion kit for cleaning on top including push-in handle	BSO5000-123		275,50
Air flap adapter ø 125 mm for direct assembly motor at device	N003156		31,00
Door handle black	02056-01		117,00

Available variants:

Front variants			
Mounting frame, black		SET213343	14965,00

¹compared to EAS: EOS control & display unit, second flush-mount box, connecting cable for control & display unit 2m long, 4x water temperature sensor with sleeve and 2x extension cable 3m long.

Energy efficiency index A +

BSO 06 + EOS



Set consists of:	Art.-Nr.	No.	Price
HKD 2.2 SK, side-opening door, single glazed		1	
Chamotte lining set HKD 2.2 SK		1	
Upper lining HKD 2.2 SK		1	
Mounting frame		1	
Thermal concrete cladding BSO 06		1	
EOS (see page 393)		1	
Mounting box		2	
Door switch wiring 2 lm		1	
Thermocouple wiring 2 lm		1	
Bus wiring 2 lm		1	
Connecting piece for side/rear smoke outlet ø 180 mm		1	
Connection wiring EOS display - control unit - 2 lm		1	
Temperature sensor with immersion sleeve		4	
Extension wiring for temperature sensor 3 lm		2	

Additional options			
Additional ring (top ring 1), Raising the BSO 06 (410 mm) *	BSO6000-006		377,00
* Differences of colour between the height extension ring and other components of BSK/BSO are due to manufacturing process and cannot be excluded. These colour differences are no reason for a claim.			
Double glazing			208,00
Set heat-protective panel	BSO6000-121		78,00
Smoke pipe outlet on top ø 180 mm	W043140		0,00
Conversion kit for cleaning on top including push-in handle	BSO5000-123		275,50
Air flap adapter ø 125 mm for direct assembly motor at device	N003156		31,00
Door handle black	02056-01		117,00

Available variants:

Front variants			
Mounting frame, black		SET213383	16612,50

Energy efficiency index A +



BSO 05 + EAS

Set consists of:	Art.-Nr.	No.	Price
HKD 7 SK, side-opening door, single glazed		1	
Chamotte lining set HKD 7 SK		1	
Upper lining HKD 7 SK		1	
Mounting frame		1	
Thermal concrete cladding BSO 05		1	
EAS (see page 191)		1	
Mounting box		1	
Door switch wiring 2 lm		1	
Thermocouple wiring 2 lm		1	
Bus wiring 2 lm		1	
Connecting piece for side/rear smoke outlet ø 180 mm		1	

Additional options			
Reduced price for EAS without display			-192,50
Additional ring (top ring 1), Extending element for BSO 05 (312 mm) *	BSO5000-007		396,50
* Differences of colour between the height extension ring and other components of BSK/BSO are due to manufacturing process and cannot be excluded. These colour differences are no reason for a claim.			
Double glazing			208,00
Set heat-protective panel	BSO5000-120		71,00
Add. charge EOS ¹			1648,00
Smoke pipe outlet on top ø 180 mm	W043140		0,00
Conversion kit for cleaning on top including push-in handle	BSO5000-123		275,50
Air flap adapter ø 125 mm for direct assembly motor at device	N003156		31,00
Door handle black	02056-01		117,00

Available variants:

Front variants			
Mounting frame, black		SET213016	16659,50

¹compared to EAS: EOS control & display unit, second flush-mount box, connecting cable for control & display unit 2m long, 4x water temperature sensor with sleeve and 2x extension cable 3m long.

Energy efficiency index A +



BSO 02 Tunnel

Set consists of:	Art.-Nr.	No.	Price
HKD 2.2 Tunnel , 2 side-opening doors, single glazed		1	
Chamotte lining set HKD 2.2 Tunnel		1	
Upper lining HKD 2.2 für BSO 02		1	
Mounting frame		2	
Modular top-mount accumulator		5	
Cast iron dome MAS ø 180 horizontal/ vertical		1	
Mounting ring for modular top-mount storage		1	
Thermal concrete cladding BSO 02		1	

Additional options

Additional ring (top ring 1), raised cladding for BSO 02 (326 mm) *	BSO2000-006		296,50
* Differences of colour between the height extension ring and other components of BSK/BSO are due to manufacturing process and cannot be excluded. These colour differences are no reason for a claim.			
Door lock as revision handle	02429		91,00
Double glazing (also one side only available on request)			416,00
Heat protective panel BSO 02 (sidewall)	BSO3000-034		108,00
Door handle black	02056-01		117,00

Available variants:

Front variants			
Mounting frame, black		SET211305	9017,50
Mounting frame, stainless steel		SET211306	9303,50

Energy efficiency index A +

BSO 02 Tunnel + EAS



Set consists of:	Art.-Nr.	No.	Price
HKD 2.2 Tunnel , 2 side-opening doors, single glazed		1	
Chamotte lining set HKD 2.2 Tunnel		1	
Upper lining HKD 2.2 für BSO 02		1	
Mounting frame		2	
Modular top-mount accumulator		5	
Cast iron dome MAS ø 180 horizontal/ vertical		1	
Mounting ring for modular top-mount storage		1	
Thermal concrete cladding BSO 02		1	
EAS (see page 191)		1	
Mounting box		1	
Door switch wiring 3 lm		1	
Thermocouple wiring 3 lm		1	
Bus wiring 3 lm		1	

Additional options			
Additional ring (top ring 1), raised cladding for BSO 02 (326 mm) *	BSO2000-006		296,50
* Differences of colour between the height extension ring and other components of BSK/BSO are due to manufacturing process and cannot be excluded. These colour differences are no reason for a claim.			
Door lock as revision handle	02429		91,00
Double glazing			416,00
Heat protective panel BSO 02 (sidewall)	BSO3000-034		108,00
Reduced price for EAS without display			-192,50
Air flap adapter ø 125 mm for direct assembly motor at device	N003156		31,00
Door handle black	02056-01		117,00

Available variants:

Front variants			
Mounting frame, black		SET211319	11269,00
Mounting frame, stainless steel		SET211320	11555,00

Energy efficiency index A +



BSO 03 Tunnel

Set consists of:	Art.-Nr.	No.	Price
HKD 2.2 Tunnel , 2 side-opening doors, single glazed		1	
Chamotte lining set HKD 2.2		1	
Upper lining HKD 2.2		1	
Mounting frame		2	
heat storage block BSO 03		1	
Segmental bend 45°		1	
Pipe conversion piece ø 180 mm, 90° assembly kit		1	
Thermal concrete cladding BSO 02		1	
Thermal concrete cladding heat storage block		1	

Additional options

Additional ring (top ring 1), raised cladding for BSO 03 storage block (290 mm high) *	BSO3000-004		288,00
Additional ring (top ring 1), raised cladding for BSO 02 (326 mm) *	BSO2000-006		296,50
* Differences of colour between the height extension ring and other components of BSK/BSO are due to manufacturing process and cannot be excluded. These colour differences are no reason for a claim.			
Double glazing			416,00
Door handle black	02056-01		117,00

Available variants:

Front variants			
Mounting frame, black		SET211311	11556,50
Mounting frame, stainless steel		SET211312	11842,50

Energy efficiency index A +

BSO 03 Tunnel + EAS



Set consists of:	Art.-Nr.	No.	Price
HKD 2.2 Tunnel , 2 side-opening doors, single glazed		1	
Chamotte lining set HKD 2.2		1	
Upper lining HKD 2.2		1	
Mounting frame		2	
heat storage block BSO 03		1	
Segmental bend 45°		1	
Pipe conversion piece ø 180 mm, 90° assembly kit		1	
Thermal concrete cladding BSO 02		1	
Thermal concrete cladding heat storage block		1	
EAS (see page 191)		1	
Mounting box		1	
Door switch wiring 3 lm		1	
Thermocouple wiring 3 lm		1	
Bus wiring 3 lm		1	

Additional options			
Additional ring (top ring 1); raised cladding for BSO 03 storage block (290 mm high) *	BSO3000-004		288,00
Additional ring (top ring 1), raised cladding for BSO 02 (326 mm) *	BSO2000-006		296,50
* Differences of colour between the height extension ring and other components of BSK/BSO are due to manufacturing process and cannot be excluded. These colour differences are no reason for a claim.			
Double glazing			416,00
Reduced price for EAS without display			-192,50
Air flap adapter ø 125 mm for direct assembly motor at device	N003156		31,00
Door handle black	02056-01		117,00

Available variants:

Front variants			
Mounting frame, black		SET211325	13808,00
Mounting frame, stainless steel		SET211326	14094,00

Energy efficiency index A +



BSO 06 Tunnel + EAS

Set consists of:	Art.-Nr.	No.	Price
HKD 2.2 SK Tunnel, side-opening door, single glazed		1	
Chamotte lining set HKD 2.2 SK Tunnel		1	
Upper lining HKD 2.2 SK		1	
Mounting frame		2	
Thermal concrete cladding BSO 06		1	
EAS (see page 191)		1	
Mounting box		1	
Door switch wiring 2 lm		1	
Thermocouple wiring 2 lm		1	
Bus wiring 2 lm		1	
Connecting piece for side/rear smoke outlet ø 180 mm		1	

Additional options

Reduced price for EAS without display			-192,50
Additional ring (top ring 1), Raising the BSO 06 (410 mm) *	BSO6000-006		377,00
* Differences of colour between the height extension ring and other components of BSK/BSO are due to manufacturing process and cannot be excluded. These colour differences are no reason for a claim.			
Double glazing			416,00
Smoke pipe outlet on top ø 180 mm	W043140		0,00
Conversion kit for cleaning on top including push-in handle	BSO5000-123		275,50
Air flap adapter ø 125 mm for direct assembly motor at device	N003156		31,00
Door handle black	02056-01		117,00

Available variants:

Front variants			
Mounting frame, black		SET213344	16978,00

¹compared to EAS: EOS control & display unit, second flush-mount box, connecting cable for control & display unit 2m long, 4x water temperature sensor with sleeve and 2x extension cable 3m long.

Energy efficiency index A +

BSO 06 Tunnel + EOS



Set consists of:	Art.-Nr.	No.	Price
HKD 2.2 SK Tunnel , side-opening door, single glazed		1	
Chamotte lining set HKD 2.2 SK Tunnel		1	
Upper lining HKD 2.2 SK		1	
Mounting frame		2	
Thermal concrete cladding BSO 06		1	
EOS (see page 393)		1	
Mounting box		2	
Door switch wiring 2 lm		1	
Thermocouple wiring 2 lm		1	
Bus wiring 2 lm		1	
Connecting piece for side/rear smoke outlet ø 180 mm		1	
Connection wiring EOS display - control unit - 2 lm		1	
Temperature sensor with immersion sleeve		4	
Extension wiring for temperature sensor 3 lm		2	

Additional options			
Additional ring (top ring 1), Raising the BSO 06 (410 mm) *	BSO6000-006		377,00
* Differences of colour between the height extension ring and other components of BSK/BSO are due to manufacturing process and cannot be excluded. These colour differences are no reason for a claim.			
Double glazing			416,00
Smoke pipe outlet on top ø 180 mm	W043140		0,00
Conversion kit for cleaning on top including push-in handle	BSO5000-123		275,50
Air flap adapter ø 125 mm for direct assembly motor at device	N003156		31,00
Door handle black	02056-01		117,00

Available variants:

Front variants			
Mounting frame, black		SET213384	18626,00

Energy efficiency index A +



BSO 05 Tunnel + EAS

Set consists of:	Art.-Nr.	No.	Price
HKD 7 SK Tunnel , side-opening door, single glazed		1	
Chamotte lining set HKD 7 SK Tunnel		1	
Upper lining HKD 7 SK		1	
Mounting frame		2	
Thermal concrete cladding BSO 05		1	
EAS (see page 191)		1	
Mounting box		1	
Door switch wiring 2 lm		1	
Thermocouple wiring 2 lm		1	
Bus wiring 2 lm		1	
Connecting piece for side/rear smoke outlet ø 180 mm		1	

Additional options

Reduced price for EAS without display			-192,50
Additional ring (top ring 1), Extending element for BSO 05 (312 mm) *	BSO5000-007		396,50
* Differences of colour between the height extension ring and other components of BSK/BSO are due to manufacturing process and cannot be excluded. These colour differences are no reason for a claim.			
Double glazing			416,00
Add. charge EOS ¹			1648,00
Smoke pipe outlet on top ø 180 mm	W043140		0,00
Conversion kit for cleaning on top including push-in handle	BSO5000-123		275,50
Air flap adapter ø 125 mm for direct assembly motor at device	N003156		31,00
Door handle black	02056-01		117,00

Available variants:

Front variants			
Mounting frame, black		SET213017	18878,50

¹compared to EAS: EOS control & display unit, second flush-mount box, connecting cable for control & display unit 2m long, 4x water temperature sensor with sleeve and 2x extension cable 3m long.

Energy efficiency index A +



BSO 01

Set consists of:	Art.-Nr.	No.	Price
HKD 2.2 short, single glazed, side-opening door round		1	
Chamotte lining set HKD 2.2 short		1	
Upper lining HKD 2.2 short		1	
Mounting frame		1	
Modular top-mount accumulator		5	
Cast iron dome MAS ø 180 horizontal/ vertical		1	
Mounting ring for modular top-mount storage		1	
Thermal concrete cladding BSO 01		1	

Additional options			
Additional ring (top ring 1), raised cladding for BSO 01 (330 mm) *	BSO1000-005		282,00
* Differences of colour between the height extension ring and other components of BSK/BSO are due to manufacturing process and cannot be excluded. These colour differences are no reason for a claim.			
Door handle black	02056-01		117,00

Available variants:

Front variants			
Mounting frame, black		SET211300	8244,00

Energy efficiency index A +

BSO 01 + EAS



Set consists of:	Art.-Nr.	No.	Price
HKD 2.2 short, single glazed, side-opening door round		1	
Chamotte lining set HKD 2.2 short		1	
Upper lining HKD 2.2 short		1	
Mounting frame		1	
Modular top-mount accumulator		5	
Cast iron dome MAS ø 180 horizontal/ vertical		1	
Mounting ring for modular top-mount storage		1	
Thermal concrete cladding BSO 01		1	
EAS (see page 191)		1	
Mounting box		1	
Door switch wiring 3 lm		1	
Thermocouple wiring 3 lm		1	
Bus wiring 3 lm		1	

Additional options			
Reduced price for EAS without display			-192,50
Additional ring (top ring 1), raised cladding for BSO 01 (330 mm) *	BSO1000-005		282,00
* Differences of colour between the height extension ring and other components of BSK/BSO are due to manufacturing process and cannot be excluded. These colour differences are no reason for a claim.			
Air flap adapter ø 125 mm for direct assembly motor at device	N003156		31,00
Door handle black	02056-01		117,00

Available variants:

Front variants			
Mounting frame, black		SET211314	10307,00

Energy efficiency index A +



Technology Sets HKD 2.2 k DR for scandinavian-CLASSIC 01 and modern ART

Set consists of:	Art.-Nr.	No.	Price
HKD 2.2 short , single glazed, side-opening door round		1	
Chamotte lining set HKD 2.2 short		1	
Upper lining HKD 2.2 short		1	
Mounting frame		1	
Support bearing		1	
Modular top-mount accumulator		5	
Cast iron dome ø 160 mm		1	
Mounting ring for modular top-mount storage		1	

Available variants:

Front variants			
Mounting frame, black		SET213129	7614,00

Energy efficiency index A +

scandinavianCLASSIC 01	scandinavianCLASSIC 01 with crown	modernART

Ceramic variants: K&K Poker tile sets must be ordered directly from K&K Poker at info@kamnarstvi-bechyne.cz

Technology Sets HKD 2.2 k DR for scandinavian-CLASSIC 01 and modern ART with EAS



Set consists of:	Art.-Nr.	No.	Price
HKD 2.2 short, single glazed, side-opening door round for EAS		1	
Chamotte lining set HKD 2.2 short		1	
Upper lining HKD 2.2 short		1	
Mounting frame		1	
Support bearing			
Modular top-mount accumulator		5	
Cast iron dome for EAS ø 160 mm		1	
Mounting ring for modular top-mount storage		1	
Mounting box		1	
EAS control unit		1	
Door switch wiring 3 lfm.		1	
Thermocouple wiring 3 lfm.		1	
Bus wiring 3 lfm.		1	
Air flap adapter ø 125 mm for direct assembly motor at device		1	

Additional options

Reduced price for EAS without display			-192,50
---------------------------------------	--	--	---------

Available variants:

Front variants			
Mounting frame, black		SET213128	9751,50

Energy efficiency index A +

scandinavianCLASSIC 01	scandinavianCLASSIC 01with crown	modernART
		

Ceramic variants: K&K Poker tile sets must be ordered directly from K&K Poker at info@kamnarstvi-bechyne.cz

Glazing formats

Flat glazing



BSK 42-66

BSK 06

BSK 08

BSK 04

Door dimensions height x width in cm

from
page
224

Tunnel formats



BSK 06 Tunnel

BSK 08 Tunnel

BSK 04 Tunnel

BSK 42-66 Tunnel

Door dimensions height x width in cm

from
page
232

Eck corners

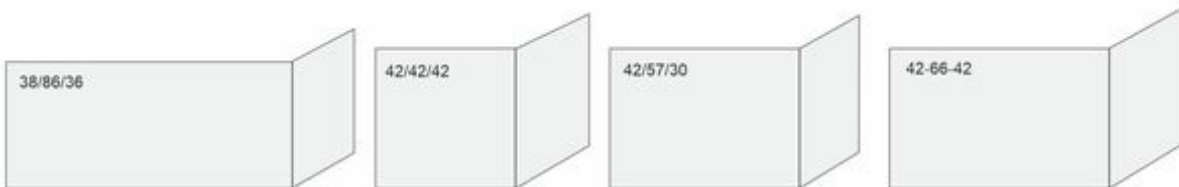

BSK 07

BSK 09

BSK 12

BSK 42-66-42

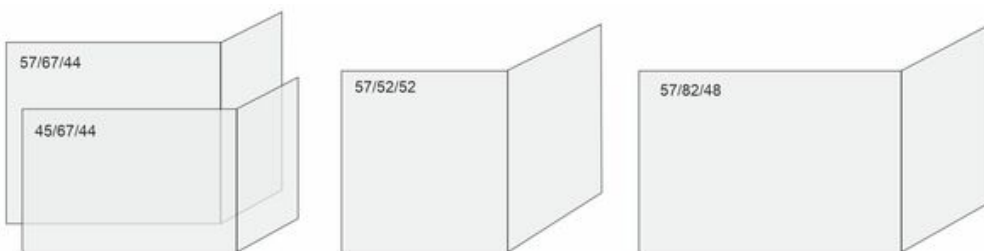

BSK 02

BSK 01

BSK 03

Door dimensions height x width x width in cm

from
page
238

flat

Tunnel

Eck

Panorama

BSK

Panorama formats

from
page
260

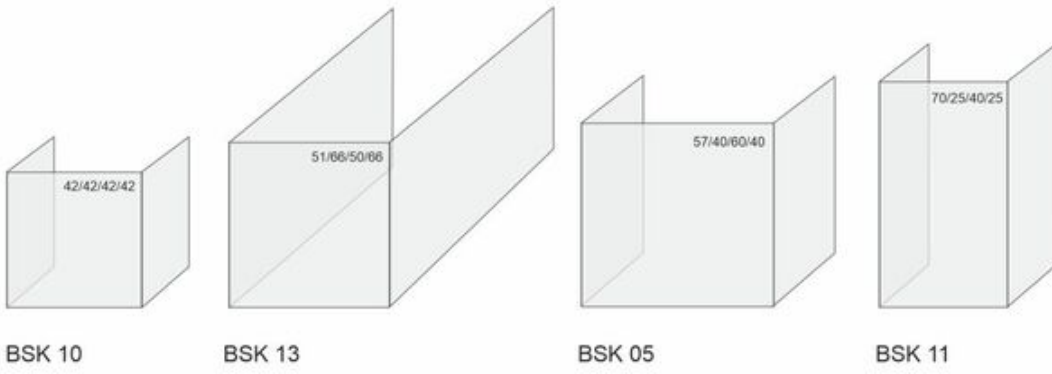

Door dimensions height x side width x front width x side width in cm

flat

Tunnel

Eck

Panorama

BSK

Door frame - mounting frame- System fireplaces

flat



Door frame



Mounting frame

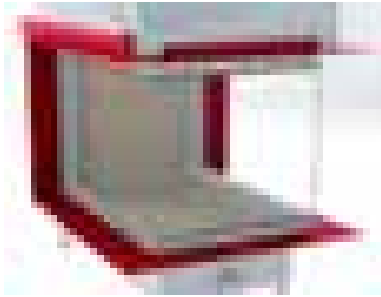

Panorama wide frame
(Fire table)

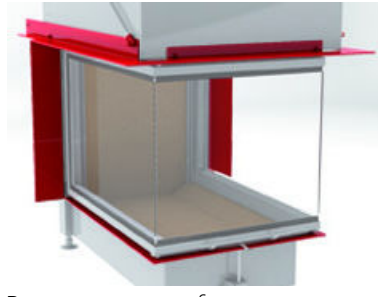

Panorama narrow frame
(Mounting bracket)

Tunnel

Supplementary equipment

- EAS** Combustion controls with potential-free relay (without additional functions) consisting of display, 1 x flush-mount box, door switch, thermocouple & bus line, each 2 m long. Preassembled EAS/EOS components, door switch, thermocouple, motor box with transmission and \varnothing 125 mm air flap, flexible hose with adjustable clamps
- EOS** Combustion control with graphic touchscreen display and additional functions (differential temperature control, Moritz's flap control) consisting of: Display with control unit, 2 x flush-mount box, door switch, thermocouple, bus and connecting line, each 2 m long, 4 x water sensors with immersion sleeve and 2x extension cable 3 m. Preassembled EOS components: door switch, thermocouple, motor box with transmission and \varnothing 125 mm air flap, flexible hose with adjustable clamps

Eck

Panorama



BSK 42-66 side-opening door

Set consists of:	Art.-Nr.	No.	Price
BKH 5.0 Flach 42-66 DT GK FR		1	
Chamotte inner lining set (FR)		1	
SET heat exchanger rings		1	
Door frame		1	
Thermal concrete cladding BSK 42-66		1	
Anschlussstutzen exzentrisch ø 200 mm		1	

Additional options			
Heat protection panel backside	HK004450		195,00
Heat protection panel backside with one side wall	HK004450-01		319,00
Heat protection panel backside with two side walls	HK004450-02		460,00
Additional ring for raised cladding *	BSK14000-113		422,50
* Differences of colour between the height extension ring and other components of BSK/BSO are due to manufacturing process and cannot be excluded. These colour differences are no reason for a claim.			
90° bend - damper flap and cleaning ø 200 mm	S002208		295,00
90° bend - damper flap and cleaning ø 180 mm	S002198		274,50
Anschlussstutzen exzentrisch ø 180 mm	S003024		175,50
EAS (see page 191)			1971,50
Reduced price for EAS without display			-192,50
Glass ceramic coated (GKB)			130,00
Combustion chamber inner lining cast iron (FR/Guss)			637,00
Catalyst module BKH 5.0	HK000210		1132,50
Supply air connection box ø 125 mm included at EAS version	HK000135		130,00

Available variants:

Front variants			
Door frame, black		SET213323	6456,00

Energy efficiency index A +

BSK 08 Stil-Kamin side-opening door 51/67, with top-mount boiler

Auslaufartikel



Set consists of:	Art.-Nr.	No.	Price
Stil-Kamin 51/67 , side-opening door, single glazing, outlet \varnothing 200 mm		1	
Chamotte lining set Stil 51/67		1	
Top-mount boiler Stil 51/67		1	
Door frame		1	
Thermal concrete cladding BSK 08		1	

Additional options

Set heat-protective panel	BSK8000-138		135,00
Additional ring for raised cladding BSK 08 *	BSK8000-006		429,50
* Differences of colour between the height extension ring and other components of BSK/BSO are due to manufacturing process and cannot be excluded. These colour differences are no reason for a claim.			
Damper flap \varnothing 200 mm with stainless steel handle	02460+10275		380,50
Conversion kit right hinge door	02380		173,00
Double glazing			375,50
Smoke pipe adapter for horizontal outlet (Attachment ring required)	BSK7000-129		527,00
EOS (see page 191)			3677,50
EAS (see page 191)			2030,00
Reduced price for EAS without display			-192,50
Air flap adapter \varnothing 125 mm for direct assembly motor at device	N003156		31,00
Socket blend stainless steel	BSK8000-126		249,50

Available variants:

Front variants			
Door frame, black		SET210580	9752,50

at lateral outlet an additional ring (BSK8000-006) and the smoke pipe adapter (BSK7000-129) are required

Energy efficiency index A +

flat

Tunnel

BSK

Eck

Panorama

Auslaufartikel



BSK 08 Stil-Kamin lifting door 51/67, with top-mount boiler

Set consists of:	Art.-Nr.	No.	Price
Stil-Kamin 51/67 , lifting door, single glazing, outlet \varnothing 200 mm		1	
Chamotte lining set Stil 51/67		1	
Top-mount boiler Stil 51/67		1	
Mounting frame		1	
Thermal concrete cladding BSK 08		1	

Additional options			
Set heat-protective panel	BSK8000-138		135,00
Additional ring for raised cladding BSK 08 *	BSK8000-006		429,50
* Differences of colour between the height extension ring and other components of BSK/BSO are due to manufacturing process and cannot be excluded. These colour differences are no reason for a claim.			
Damper flap \varnothing 200 mm with stainless steel handle	02460+10275		380,50
Double glazing			375,50
Counterweights for non-self closing door	49097		60,50
Smoke pipe adapter for horizontal outlet (Attachment ring required)	BSK7000-129		527,00
EOS (see page 191)			3677,50
EAS (see page 191)			2030,00
Reduced price for EAS without display			-192,50
Air flap adapter \varnothing 125 mm for direct assembly motor at device	N003156		31,00
Socket blend stainless steel	BSK8000-126		249,50

Available variants:

Front variants			
Mounting frame, black		SET210582	10862,00

at lateral outlet an additional ring (BSK8000-006) and the smoke pipe adapter (BSK7000-129) are required

Energy efficiency index A +

BSK 08 Stil-Kamin side-opening door 51/67, hot air convection top

Auslaufartikel



Set consists of:	Art.-Nr.	No.	Price
Stil-Kamin 51/67 , side-opening door, single glazing, outlet ø 250 mm		1	
Chamotte lining set Stil 51/67		1	
hot air convection top Stil 51/67		1	
Door frame		1	
Thermal concrete cladding BSK 08		1	

Additional options

Protective panels for BSK 08 back wall	BSK8000-123		318,50
Heat protective panels for BSK 08 side wall	BSK8000-121		242,00
Additional ring for raised cladding BSK 08 *	BSK8000-006		429,50
* Differences of colour between the height extension ring and other components of BSK/BSO are due to manufacturing process and cannot be excluded. These colour differences are no reason for a claim.			
Damper flap ø 250 mm with stainless steel handle	02461+10275		394,00
Conversion kit right hinge door	02380		173,00
Double glazing			375,50
Exchange connectiong pieceø 180 mm	I019448		79,50
Exchange connectiong pieceø 200 mm	I019449		79,50
Smoke pipe adapter for horizontal outlet	I019490		388,50
EAS (see page 191)			2030,00
Reduced price for EAS without display			-192,50
Air flap adapter ø 125 mm for direct assembly motor at device	N003156		31,00
Socket blend stainless steel	BSK8000-126		249,50

Available variants:

Front variants			
Door frame, black		SET210571	7371,00

at rear and lateral outlet the smoke pipe adapter (I019490) is required

Energy efficiency class A

Auslaufartikel



BSK 08 Stil-Kamin lifting door 51/67, hot air convection top

Set consists of:	Art.-Nr.	No.	Price
Stil-Kamin 51/67, lifting door, single glazing, outlet ø 250 mm		1	
Chamotte lining set Stil 51/67		1	
hot air convection top Stil 51/67		1	
Mounting frame		1	
Thermal concrete cladding BSK 08		1	

Additional options			
Protective panels for BSK 08 back wall	BSK8000-123		318,50
Heat protective panels for BSK 08 side wall	BSK8000-121		242,00
Additional ring for raised cladding BSK 08 *	BSK8000-006		429,50
* Differences of colour between the height extension ring and other components of BSK/BSO are due to manufacturing process and cannot be excluded. These colour differences are no reason for a claim.			
Damper flap ø 250 mm with stainless steel handle	02461+10275		394,00
Double glazing			375,50
Counterweights for non-self closing door	49097		60,50
Exchange connecting piece ø 180 mm	I019448		79,50
Exchange connecting piece ø 200 mm	I019449		79,50
Smoke pipe adapter for horizontal outlet	I019490		388,50
EAS (see page 191)			2030,00
Reduced price for EAS without display			-192,50
Air flap adapter ø 125 mm for direct assembly motor at device	N003156		31,00
Socket blend stainless steel	BSK8000-126		249,50

Available variants:

Front variants			
Mounting frame, black		SET210573	8480,50

at rear and lateral outlet the smoke pipe adapter (I019490) is required

Energy efficiency class A

flat

Tunnel

BSK

Eck

Panorama



BSK 04 Stil-Kamin 62/76 lifting door

Set consists of:	Art.-Nr.	No.	Price
Stil-Kamin 62/76 , lifting door, single glazing, outlet ø 200 mm		1	
Brick plates 62/76		1	
Mounting frame		1	
Thermal concrete cladding BSK 04		1	
Cast iron hot air hood ø 200 mm		1	

Additional options			
Heat protective panels for BSK 04 back wall	BSK4000-118		234,00
Heat protective panels for BSK 04 side wall	BSK4000-119		187,00
Additional ring for raised cladding BSK 04 *	BSK4000-009		457,50
* Differences of colour between the height extension ring and other components of BSK/BSO are due to manufacturing process and cannot be excluded. These colour differences are no reason for a claim.			
Damper flap ø 200 mm with stainless steel handle	02460+10275		380,50
Double glazing			542,00
Counterweights for non-self closing door	49097		60,50
Spare connecting piece ø 250 mm	R014022-02		0,00
Spare connecting piece ø 180 mm	R014022-03		0,00
EAS (see page 191)			2030,00
Reduced price for EAS without display			-192,50
Socket blend stainless steel	BSK4000-122		249,50

Available variants:

Front variants			
Mounting frame, black 50 mm		SET213040	9897,00

Energy efficiency class A

Auslaufartikel



BSK 06 AK 45/101 lifting door, hot air convection top

Set consists of:	Art.-Nr.	No.	Price
Architektur-Kamin 45/101 , lifting door, single glazing, outlet \varnothing 250 mm		1	
Chamotte lining set, bright, for AK 45/101		1	
Mounting frame		1	
Thermal concrete cladding BSK 06		1	
hot air convection top BSK 06		1	

Additional options

Heat protective panels for BSK 06 back wall	BSK6000-135		409,50
Heat protective panels for BSK 06 side wall	BSK6000-136		187,00
Additional ring for raised cladding BSK 06 *	BSK6000-009		483,50
* Differences of colour between the height extension ring and other components of BSK/BSO are due to manufacturing process and cannot be excluded. These colour differences are no reason for a claim.			
Damper flap \varnothing 250 mm with stainless steel handle	02461+10275		394,00
Double glazing			526,50
Counterweights for non-self closing door	49097		60,50
Exchange connectiong piece \varnothing 180 mm	I019448		79,50
Exchange connectiong piece \varnothing 200 mm	I019449		79,50
Smoke pipe adapter for horizontal outlet	I019490		388,50
EAS (see page 191)			2030,00
Reduced price for EAS without display			-192,50
Air flap adapter \varnothing 125 mm for direct assembly motor at device	N003156		31,00

Available variants:

Front variants			
Mounting frame, black 50 mm		SET207439	10238,00

Energy efficiency class A

flat

Tunnel

BSK

Eck

Panorama

BSK 06 AK 45/101 lifting door, with top-mount boiler

Auslaufartikel



Set consists of:	Art.-Nr.	No.	Price
Architektur-Kamin 45/101 , lifting door, single glazing, outlet ø 250 mm		1	
Chamotte lining set, bright, for AK 45/101		1	
Top-mount boiler AK 45/101		1	
Mounting frame		1	
Thermal concrete cladding BSK 06		1	

Additional options			
EOS (see page 191)			3677,50
EAS (see page 191)			2030,00
Reduced price for EAS without display			-192,50
Air flap adapter ø 125 mm for direct assembly motor at device	N003156		31,00
Set- heat protective panel 1x rear - 1x lateral	BSK6000-140		133,50
Additional ring for raised cladding BSK 06 *	BSK6000-009		483,50
* Differences of colour between the height extension ring and other components of BSK/BSO are due to manufacturing process and cannot be excluded. These colour differences are no reason for a claim.			
Damper flap ø 250 mm with stainless steel handle	02461+10275		394,00
Double glazing			526,50
Counterweights for non-self closing door	49097		60,50
Smoke pipe adapter for horizontal outlet	I019490		388,50

Available variants:

Front variants			
Mounting frame, black 50 mm		SET205293	13182,50

Energy efficiency index A +



BSK Tunnel 42-66, DT/DT

Set consists of:	Art.-Nr.	No.	Price
BKH 5.0 Tunnel 42-66 DT/DT GK FR		1	
Chamotte inner lining set (FR)		1	
SET heat exchanger rings		1	
Door frame		2	
Thermal concrete cladding BSK Tunnel 42-66		1	
Anschlussstutzen exzentrisch ø 200 mm		1	

Additional options			
Heat protection panel for one side	HK014251		158,00
Additional ring for raised cladding *	BSK14000-113		422,50
* Differences of colour between the height extension ring and other components of BSK/BSO are due to manufacturing process and cannot be excluded. These colour differences are no reason for a claim.			
90° bend - damper flap and cleaning ø 200 mm	S002208		295,00
90° bend - damper flap and cleaning ø 180 mm	S002198		274,50
Anschlussstutzen exzentrisch ø 180 mm	S003024		175,50
EAS (see page 191)			1971,50
Reduced price for EAS without display			-192,50
Glass ceramic coated (GKB)			260,00
Combustion chamber inner lining cast iron (FR/Guss)			377,00
Catalyst module BKH 5.0	HK000210		1132,50
Supply air connection box ø 125 mm included at EAS version	HK000135		130,00

Available variants:

Front variants			
Door frame, black		SET213324	8220,00

Energy efficiency index A +

BSK 08 Stil-Kamin Tunnel 51/67, ST/DT, with top-mount boiler

Auslaufartikel



Set consists of:	Art.-Nr.	No.	Price
Stil-Kamin Tunnel 51/67 , lifting door/side opening door, single glazing, outlet ø 200 mm		1	
Chamotte lining set Stil 51/67		1	
Top-mount boiler Stil 51/67		1	
Door frame DT		1	
Mounting frame ST		1	
Thermal concrete cladding BSK 08		1	

Additional options

Additional ring for raised cladding BSK 08 *	BSK8000-006		429,50
* Differences of colour between the height extension ring and other components of BSK/BSO are due to manufacturing process and cannot be excluded. These colour differences are no reason for a claim.			
Damper flap ø 200 mm with stainless steel handle	02460+10275		380,50
Revision handle	02426		169,00
Double glazing (also one side only available on request)			751,50
Counterweights for non-self closing door	49097		60,50
Smoke pipe adapter for horizontal outlet (Attachment ring required)	BSK7000-129		527,00
EOS (see page 191)			3866,00
EAS (see page 191)			2218,50
Reduced price for EAS without display			-192,50
Air flap adapter ø 125 mm for direct assembly motor at device	N003156		31,00
Socket blend stainless steel	BSK8000-126		249,50

Available variants:

Front variants			
Door frame or mounting frame 50 mm black		SET210586	14148,00

at lateral outlet an additional ring (BSK8000-006) and the smoke pipe adapter (BSK7000-129) are required

Energy efficiency index A +

Flat

Tunnel

BSK

Eck

Panorama

Auslaufartikel



BSK 08 Stil-Kamin Tunnel 51/67, ST/DT, hot air convection top

Set consists of:	Art.-Nr.	No.	Price
Stil-Kamin Tunnel 51/67 , lifting door/side opening door, single glazing, outlet ø 250 mm		1	
Chamotte lining set Stil 51/67		1	
hot air convection top 51/67		1	
Door frame DT		1	
Mounting frame ST		1	
Thermal concrete cladding BSK 08		1	

Additional options

Heat protective panels for BSK 08 side wall	BSK8000-121		242,00
Additional ring for raised cladding BSK 08 *	BSK8000-006		429,50
* Differences of colour between the height extension ring and other components of BSK/BSO are due to manufacturing process and cannot be excluded. These colour differences are no reason for a claim.			
Damper flap ø 250 mm with stainless steel handle	02461+10275		394,00
Revision handle	02426		169,00
Double glazing (also one side only available on request)			751,50
Counterweights for non-self closing door	49097		60,50
Exchange connectiong piece ø 180 mm	I019448		79,50
Exchange connectiong piece ø 200 mm	I019449		79,50
Smoke pipe adapter for horizontal outlet	I019490		388,50
EAS (see page 191)			2218,50
Reduced price for EAS without display			-192,50
Air flap adapter ø 125 mm for direct assembly motor at device	N003156		31,00
Socket blend stainless steel	BSK8000-126		249,50

Available variants:

Front variants			
Door frame or mounting frame, 50 mm black		SET210578	11766,50

at rear and lateral outlet the smoke pipe adapter (I019490) is required

Energy efficiency class A

flat

Tunnel

BSK

Eck

Panorama



BSK 04

Set consists of:	Art.-Nr.	No.	Price
Stil-Kamin Tunnel 62/76 , lifting/tilting door, single glazing, outlet ø 250 mm		1	
Chamotte lining set 62/76 Tunnel		1	
Mounting frame		2	
Thermal concrete cladding BSK 04		1	

Additional options			
Heat protective panels for BSK 04 side wall	BSK4000-119		187,00
Additional ring for raised cladding BSK 04 *	BSK4000-009		457,50
* Differences of colour between the height extension ring and other components of BSK/BSO are due to manufacturing process and cannot be excluded. These colour differences are no reason for a claim.			
Damper flap ø 250 mm with stainless steel handle	02461+10275		394,00
Double glazing (also one side only available on request)			1084,00
Counterweights for non-self closing door	49097		60,50
Version with 2 lifting doors upon request			
Socket blend stainless steel	BSK4000-122		249,50

Available variants:

Front variants			
Mounting frame, black 50 mm		SET207435	12885,50

Energy efficiency class A

BSK 06 AK 45/101 lifting/tilting door, hot air convection top

Auslaufartikel



Set consists of:	Art.-Nr.	No.	Price
AK 45/101 , lifting/tilting door, single glazing, outlet ø 250 mm		1	
Chamotte lining set, bright, for AK 45/101 Tunnel		1	
hot air convection top AK 45/101		1	
Mounting frame		2	
Thermal concrete cladding BSK 06		1	

Additional options			
Heat protective panels for BSK 06 side wall	BSK6000-136		187,00
Additional ring for raised cladding BSK 06 *	BSK6000-009		483,50
* Differences of colour between the height extension ring and other components of BSK/BSO are due to manufacturing process and cannot be excluded. These colour differences are no reason for a claim.			
Damper flap ø 250 mm with stainless steel handle	02461+10275		394,00
Double glazing (also one side only available on request)			1053,00
Counterweights for non-self closing door	49097		60,50
Exchange connection piece ø 180 mm	I019448		79,50
Exchange connection piece ø 200 mm	I019449		79,50
Smoke pipe adapter for horizontal outlet	I019490		388,50
EAS (see page 191)			2030,00
Reduced price for EAS without display			-192,50
Air flap adapter ø 125 mm for direct assembly motor at device	N003156		31,00
Lifting doors on both sides available upon request			

Available variants:

Front variants			
Mounting frame, black, 50 mm		SET207443	13281,50

Energy efficiency class A

flat

Tunnel

BSK

Eck

Panorama

BSK 06 AK 45/101 lifting/tilting door, with top-mount boiler

Auslaufartikel



Set consists of:	Art.-Nr.	No.	Price
AK 45/101, lifting/tilting door, single glazing, outlet ø 250 mm		1	
Chamotte lining set, bright, for AK 45/101 Tunnel		1	
Top-mount boiler AK 45/101		1	
Mounting frame		2	
Thermal concrete cladding BSK 06		1	

Additional options			
EOS (see page 191)			3677,50
EAS (see page 191)			2030,00
Reduced price for EAS without display			-192,50
Air flap adapter ø 125 mm for direct assembly motor at device	N003156		31,00
Additional ring for raised cladding BSK 06 *	BSK6000-009		483,50
* Differences of colour between the height extension ring and other components of BSK/BSO are due to manufacturing process and cannot be excluded. These colour differences are no reason for a claim.			
Damper flap ø 250 mm with stainless steel handle	02461+10275		394,00
Counterweights for non-self closing door	49097		60,50
Double glazing (also one side only available on request)			1053,00
Smoke pipe adapter for horizontal outlet	I019490		388,50
Lifting doors on both sides available upon request			

Available variants:

Front variants			
Mounting frame, black 50 mm		SET208980	16226,00

Energy efficiency index A +

Flat

Tunnel

BSK

Eck

Panorama



BSK Eck 42-66-42 DTL

Set consists of:	Art.-Nr.	No.	Price
BKH 5.0 Eck 42-66-42 DTL, two-piece ceramic glass		1	
Chamotte inner lining set (FR)		1	
SET heat exchanger rings		1	
Door frame		1	
Thermal concrete cladding BSK Eck		1	
Anschlussstutzen exzentrisch ø 200 mm		1	

Additional options			
Heat protection panel with one side wall	HK021450		351,00
Additional ring for raised cladding *	BSK14000-113		422,50
* Differences of colour between the height extension ring and other components of BSK/BSO are due to manufacturing process and cannot be excluded. These colour differences are no reason for a claim.			
90° bend - damper flap and cleaning ø 200 mm	S002208		295,00
90° bend - damper flap and cleaning ø 180 mm	S002198		274,50
Anschlussstutzen exzentrisch ø 180 mm	S003024		175,50
EAS (see page 191)			1971,50
Reduced price for EAS without display			-192,50
Glass ceramic coated (GKB)			325,00
Combustion chamber inner lining cast iron (FR/Guss)			429,00
Catalyst module BKH 5.0	HK000210		1132,50
Supply air connection box ø 125 mm included at EAS version	HK000135		130,00

Available variants:

Front variants			
Door frame, black		SET213325	7441,00

Energy efficiency index A +



BSK Eck 42-66-42 DTR

Set consists of:	Art.-Nr.	No.	Price
BKH 5.0 Eck 42-66-42 DTR, two-piece ceramic glass		1	
Chamotte inner lining set (FR)		1	
SET heat exchanger rings		1	
Door frame		1	
Thermal concrete cladding BSK Eck		1	
Anschlusstutzen exzentrisch ø 200 mm		1	

Additional options			
Heat protection panel with one side wall	HK021450		351,00
Additional ring for raised cladding *	BSK14000-113		422,50
* Differences of colour between the height extension ring and other components of BSK/BSO are due to manufacturing process and cannot be excluded. These colour differences are no reason for a claim.			
90° bend - damper flap and cleaning ø 200 mm	S002208		295,00
90° bend - damper flap and cleaning ø 180 mm	S002198		274,50
Anschlusstutzen exzentrisch ø 180 mm	S003024		175,50
EAS (see page 191)			1971,50
Reduced price for EAS without display			-192,50
Glass ceramic coated (GKB)			325,00
Combustion chamber inner lining cast iron (FR/ Guss)			429,00
Catalyst module BKH 5.0	HK000210		1132,50
Supply air connection box ø 125 mm included at EAS version	HK000135		130,00

Available variants:

Front variants			
Door frame, black		SET213326	7441,00

Energy efficiency index A +

Auslaufartikel



BSK 09 with top-mount heat exchanger

Set consists of:	Art.-Nr.	No.	Price
Eck 42/42/42, side-opening door, single glazing two-piece ceramic glass		1	
Chamotte lining set Eck 42/42/42		1	
Cast iron hot air hood ø 200 mm		1	
Door frame		1	
Thermal concrete cladding BSK 09		1	

Additional options

Heat protective panels for BSK 09 side & back walls	BSK9000-128		260,50
Additional ring for raised cladding BSK 09 *	BSK9000-008		302,50
* Differences of colour between the height extension ring and other components of BSK/BSO are due to manufacturing process and cannot be excluded. These colour differences are no reason for a claim.			
Conversion kit right hinge door	02380		173,00
EAS (see page 191)			2030,00
Reduced price for EAS without display			-192,50
Air flap adapter ø 125 mm for direct assembly motor at device	N003156		31,00
Socket blend stainless steel	BSK9000-131		217,00

Available variants:



Front variants			
Door frame, black		SET213041	6792,00

Energy efficiency index A +

flat

Tunnel

BSK

Eck

Panorama

Auslaufartikel



BSK 09 with top- mount accumulator

Set consists of:	Art.-Nr.	No.	Price
Eck 42/42/42, side-opening door, single glazing two-piece ceramic glass		1	
Chamotte lining set Eck 42/42/42		1	
Modular top-mount accumulator		4	
Cast iron dome MAS ø 180 horizontal/ vertical		1	
Mounting ring for modular top-mount storage		1	
Door frame		1	
Thermal concrete cladding BSK 09		1	

Additional options			
Heat protective panels for BSK 09 side & back walls	BSK9000-128		260,50
Additional ring for raised cladding BSK 09 *	BSK9000-008		302,50
* Differences of colour between the height extension ring and other components of BSK/BSO are due to manufacturing process and cannot be excluded. These colour differences are no reason for a claim.			
Conversion kit right hinge door	02380		173,00
EAS (see page 191)			2030,00
Reduced price for EAS without display			-192,50
Air flap adapter ø 125 mm for direct assembly motor at device	N003156		31,00
Socket blend stainless steel	BSK9000-131		217,00

Available variants:



Front variants			
Door frame, black		SET211402	8172,50

Energy efficiency index A +

Flat

Tunnel

BSK

Eck

Panorama

Auslaufartikel



BSK 01 side-opening door

Set consists of:	Art.-Nr.	No.	Price
Eck 57/52/52 , side-opening door, single glazing two-piece ceramic glass		1	
Chamotte lining set Eck 57/52/52		1	
Cast iron hot air hood ø 200 mm		1	
Door frame		1	
Thermal concrete cladding BSK 01		1	

Additional options

Heat protective panels for BSK 01 side & back walls	BSK1000-143		303,50
Damper flap ø 200 mm with stainless steel handle	02460+10275		380,50
Additional ring for raised cladding BSK 01 *	BSK1000-009		309,00
* Differences of colour between the height extension ring and other components of BSK/BSO are due to manufacturing process and cannot be excluded. These colour differences are no reason for a claim.			
Conversion kit right hinge door	02380		173,00
Spare connecting piece ø 250 mm	R014022-02		0,00
Spare connecting piece ø 180 mm	R014022-03		0,00
EAS (see page 191)			2030,00
Reduced price for EAS without display			-192,50
Air flap adapter ø 125 mm for direct assembly motor at device	N003156		31,00
Socket blend stainless steel	BSK1000-153		217,00

Available variants:

Front variants			
Door frame, black		SET213042	7351,00

Energy efficiency class A

flat

Tunnel

BSK

Eck

Panorama

Auslaufartikel



BSK 01 lifting door

Set consists of:	Art.-Nr.	No.	Price
Eck 57/52/52 , lifting door, single glazing two-piece ceramic glass		1	
Chamotte lining set Eck 57/52/52		1	
Cast iron hot air hood ø 200 mm		1	
Mounting frame		1	
Thermal concrete cladding BSK 01		1	

Additional options			
Heat protective panels for BSK 01 side & back walls	BSK1000-143		303,50
Counterweights for non-self closing door	49097		60,50
Damper flap ø 200 mm with stainless steel handle	02460+10275		380,50
Additional ring for raised cladding BSK 01 *	BSK1000-009		309,00
* Differences of colour between the height extension ring and other components of BSK/BSO are due to manufacturing process and cannot be excluded. These colour differences are no reason for a claim.			
Spare connecting piece ø 250 mm	R014022-02		0,00
Spare connecting piece ø 180 mm	R014022-03		0,00
EAS (see page 191)			2030,00
Reduced price for EAS without display			-192,50
Air flap adapter ø 125 mm for direct assembly motor at device	N003156		31,00
Socket blend stainless steel	BSK1000-153		217,00

Available variants:

Front variants			
Mounting frame, black 50 mm		SET213043	8634,50

Energy efficiency class A



BSK 02 Corner fireplace waterbearing 45/67/44 left side, lifting door

Set consists of:	Art.-Nr.	No.	Price
Corner fireplace waterbearing 45/67/44, left side, lifting door two-piece ceramic glass, outlet ø 180 mm		1	
Chamotte lining set, bright, for Eck-Kamin 45/67/44 l/r		1	
Thermal concrete cladding BSK 02		1	
ISO upper lining		1	

Additional options			
EOS (see page 191)			3677,50
EAS (see page 191)			2030,00
Reduced price for EAS without display			-192,50
Air flap adapter ø 125 mm for direct assembly motor at device	N003156		31,00
Counterweights for non-self closing door	49097		60,50
Set- heat protective panel 1x rear - 1x lateral	BSK2000-208		50,00
Additional ring for raised cladding BSK 02 *	BSK2000-007		396,50
* Differences of colour between the height extension ring and other components of BSK/BSO are due to manufacturing process and cannot be excluded. These colour differences are no reason for a claim.			
Conversion kit for cleaning on top including push-in handle	BSK2000-201		272,50
Socket blend stainless steel	BSK2000-162		217,00

Available variants:

Front variants			
Mounting frame, black 50 mm		SET212994	12322,50

Energy efficiency index A +

BSK 02 Corner fireplace waterbearing 45/67/44 right side, lifting door



Set consists of:	Art.-Nr.	No.	Price
Corner fireplace waterbearing 45/67/44, right side, lifting door two-piece ceramic glass, outlet ø 180 mm		1	
Chamotte lining set, bright, for Eck-Kamin 45/67/44 l/r		1	
Thermal concrete cladding BSK 02		1	
ISO upper lining		1	

Additional options			
EOS (see page 191)			3677,50
EAS (see page 191)			2030,00
Reduced price for EAS without display			-192,50
Air flap adapter ø 125 mm for direct assembly motor at device	N003156		31,00
Counterweights for non-self closing door	49097		60,50
Set- heat protective panel 1x rear - 1x lateral	BSK2000-208		50,00
Additional ring for raised cladding BSK 02 *	BSK2000-007		396,50
* Differences of colour between the height extension ring and other components of BSK/BSO are due to manufacturing process and cannot be excluded. These colour differences are no reason for a claim.			
Conversion kit for cleaning on top including push-in handle	BSK2000-201		272,50
Socket blend stainless steel	BSK2000-162		217,00

Available variants:

Front variants			
Mounting frame, black 50 mm		SET212996	12322,50

Energy efficiency index A +

Auslaufartikel



BSK 02 Eck 45/67/44 left side, lifting door

Set consists of:	Art.-Nr.	No.	Price
Eck 45/67/44, left side , lifting door, single glazing two-piece ceramic glass		1	
Chamotte lining set Eck 45/67/44 l		1	
Cast iron hot air hood ø 200 mm		1	
Thermal concrete cladding BSK 02		1	

Additional options

Heat protective panels for BSK 02 side & back walls	BSK2000-125		351,00
Damper flap ø 200 mm with stainless steel handle	02460+10275		380,50
Spare connecting piece ø 250 mm	R014022-02		0,00
Spare connecting piece ø 180 mm	R014022-03		0,00
Counterweights for non-self closing door	49097		60,50
Additional ring for raised cladding BSK 02 *	BSK2000-007		396,50
* Differences of colour between the height extension ring and other components of BSK/BSO are due to manufacturing process and cannot be excluded. These colour differences are no reason for a claim.			
EAS (see page 191)			2030,00
Reduced price for EAS without display			-192,50
Air flap adapter ø 125 mm for direct assembly motor at device	N003156		31,00
Socket blend stainless steel	BSK2000-162		217,00

Available variants:

Front variants			
Mounting frame, black 50 mm		SET213044	9110,00

Energy efficiency class A

flat

Tunnel

BSK

Eck

Panorama

Auslaufartikel



BSK 02 Eck 45/67/44 right side, lifting door

Set consists of:	Art.-Nr.	No.	Price
Eck 45/67/44, right side, lifting door, single glazing two-piece ceramic glass		1	
Chamotte lining set Eck 45/67/44 r		1	
Cast iron hot air hood ø 200 mm		1	
Thermal concrete cladding BSK 02		1	

Additional options			
Heat protective panels for BSK 02 side & back walls	BSK2000-125		351,00
Damper flap ø 200 mm with stainless steel handle	02460+10275		380,50
Counterweights for non-self closing door	49097		60,50
Spare connecting piece ø 250 mm	R014022-02		0,00
Spare connecting piece ø 180 mm	R014022-03		0,00
Additional ring for raised cladding BSK 02 *	BSK2000-007		396,50
* Differences of colour between the height extension ring and other components of BSK/BSO are due to manufacturing process and cannot be excluded. These colour differences are no reason for a claim.			
EAS (see page 191)			2030,00
Reduced price for EAS without display			-192,50
Air flap adapter ø 125 mm for direct assembly motor at device	N003156		31,00
Socket blend stainless steel	BSK2000-162		217,00

Available variants:

Front variants			
Mounting frame, black 50 mm		SET213045	9110,00

Energy efficiency class A

Flat

Tunnel

BSK

Eck

Panorama

Auslaufartikel



BSK 02 Eck 57/67/44 left side, lifting door

Set consists of:	Art.-Nr.	No.	Price
Eck 57/67/44, left side , lifting door, single glazing two-piece ceramic glass		1	
Chamotte lining set Eck 57/67/44 l		1	
Cast iron hot air hood ø 200 mm		1	
Thermal concrete cladding BSK 02		1	

Additional options			
Heat protective panels for BSK 02 side & back walls	BSK2000-125		351,00
Damper flap ø 200 mm with stainless steel handle	02460+10275		380,50
Counterweights for non-self closing door	49097		60,50
Spare connecting piece ø 250 mm	R014022-02		0,00
Spare connecting piece ø 180 mm	R014022-03		0,00
Additional ring for raised cladding BSK 02 *	BSK2000-007		396,50
* Differences of colour between the height extension ring and other components of BSK/BSO are due to manufacturing process and cannot be excluded. These colour differences are no reason for a claim.			
EAS (see page 191)			2030,00
Reduced price for EAS without display			-192,50
Air flap adapter ø 125 mm for direct assembly motor at device	N003156		31,00
Socket blend stainless steel	BSK2000-162		217,00

Available variants:

Front variants			
Mounting frame, black 50 mm		SET213046	9299,50

Energy efficiency class A

flat

Tunnel

BSK

Eck

Panorama

Auslaufartikel



BSK 02 Eck 57/67/44 right side, lifting door

Set consists of:	Art.-Nr.	No.	Price
Eck 57/67/44, right side, lifting door, single glazing two-piece ceramic glass		1	
Chamotte lining set Eck 57/67/44 r		1	
Cast iron hot air hood ø 200 mm		1	
Thermal concrete cladding BSK 02		1	

Additional options			
Heat protective panels for BSK 02 side & back walls	BSK2000-125		351,00
Damper flap ø 200 mm with stainless steel handle	02460+10275		380,50
Counterweights for non-self closing door	49097		60,50
Spare connecting piece ø 250 mm	R014022-02		0,00
Spare connecting piece ø 180 mm	R014022-03		0,00
Additional ring for raised cladding BSK 02 *	BSK2000-007		396,50
* Differences of colour between the height extension ring and other components of BSK/BSO are due to manufacturing process and cannot be excluded. These colour differences are no reason for a claim.			
EAS (see page 191)			2030,00
Reduced price for EAS without display			-192,50
Air flap adapter ø 125 mm for direct assembly motor at device	N003156		31,00
Socket blend stainless steel	BSK2000-162		217,00

Available variants:

Front variants			
Mounting frame, black 50 mm		SET213047	9299,50

Energy efficiency class A

Auslaufartikel



BSK 03 Eck left side, lifting door

Set consists of:	Art.-Nr.	No.	Price
Eck 57/82/48, left side , lifting door, single glazing two-piece ceramic glass		1	
Chamotte lining set Eck 57/82/48 l		1	
Cast iron hot air hood ø 200 mm		1	
Thermal concrete cladding BSK 03		1	

Additional options			
Heat protective panels for BSK 02 side & back walls	BSK3000-129		420,50
Damper flap ø 200 mm with stainless steel handle	02460+10275		380,50
Counterweights for non-self closing door	49097		60,50
Spare connecting piece ø 250 mm	R014022-02		0,00
Spare connecting piece ø 180 mm	R014022-03		0,00
Additional ring for raised cladding BSK 03 *	BSK3000-007		405,50
* Differences of colour between the height extension ring and other components of BSK/BSO are due to manufacturing process and cannot be excluded. These colour differences are no reason for a claim.			
EAS (see page 191)			2030,00
Reduced price for EAS without display			-192,50
Air flap adapter ø 125 mm for direct assembly motor at device	N003156		31,00
Socket blend stainless steel	BSK3000-142		249,50

Available variants:

Front variants			
Mounting frame, black 50 mm		SET213048	10382,00

Energy efficiency class A

flat

Tunnel

BSK

Eck

Panorama

Auslaufartikel



BSK 03 Eck right side, lifting door

Set consists of:	Art.-Nr.	No.	Price
Eck 57/82/48, right side , lifting door, single glazing two-piece ceramic glass		1	
Chamotte lining set Eck 57/82/48 r		1	
Cast iron hot air hood ø 200 mm		1	
Thermal concrete cladding BSK 03		1	

Additional options			
Heat protective panels for BSK 02 side & back walls	BSK3000-129		420,50
Damper flap ø 200 mm with stainless steel handle	02460+10275		380,50
Counterweights for non-self closing door	49097		60,50
Spare connecting piece ø 250 mm	R014022-02		0,00
Spare connecting piece ø 180 mm	R014022-03		0,00
Additional ring for raised cladding BSK 03 *	BSK3000-007		405,50
* Differences of colour between the height extension ring and other components of BSK/BSO are due to manufacturing process and cannot be excluded. These colour differences are no reason for a claim.			
EAS (see page 191)			2030,00
Reduced price for EAS without display			-192,50
Air flap adapter ø 125 mm for direct assembly motor at device	N003156		31,00
Socket blend stainless steel	BSK3000-142		249,50

Available variants:

Front variants			
Mounting frame, black 50 mm		SET213049	10382,00

Energy efficiency class A

Flat

Tunnel

BSK

Eck

Panorama

Auslaufartikel



BSK 07 low left side

Set consists of:	Art.-Nr.	No.	Price
Eck 38/86/36, left side , lifting door, single glazing two-piece ceramic glass, outlet ø 200 mm		1	
Chamotte lining set Eck 38/86/36		1	
Thermal concrete cladding BSK 07		1	

Additional options			
Heat protective panels for BSK 07 side & back walls	BSK7000-131		374,50
Damper flap ø 200 mm with stainless steel handle	02460+10275		380,50
Smoke pipe adapter for horizontal/vertical outlet Spare connecting piece not possible	BSK7000-129		527,00
Counterweights for non-self closing door	49097		60,50
Additional ring for raised cladding BSK 07 *	BSK7000-007		457,50
* Differences of colour between the height extension ring and other components of BSK/BSO are due to manufacturing process and cannot be excluded. These colour differences are no reason for a claim.			
EAS (see page 191)			2030,00
Reduced price for EAS without display			-192,50
Air flap adapter ø 125 mm for direct assembly motor at device	N003156		31,00
Socket blend stainless steel	BSK7000-137		217,00

Available variants:

Front variants			
Mounting frame, black 50 mm		SET211196	9594,00

flat

Tunnel

BSK

Eck

Panorama

Auslaufartikel



BSK 07 low right side

Set consists of:	Art.-Nr.	No.	Price
Eck 38/86/36, right side , lifting door, single glazing two-piece ceramic glass, outlet ø 200 mm		1	
Chamotte lining set Eck 38/86/36		1	
Thermal concrete cladding BSK 07		1	

Additional options			
Heat protective panels for BSK 07 side & back walls	BSK7000-131		374,50
Damper flap ø 200 mm with stainless steel handle	02460+10275		380,50
Smoke pipe adapter for horizontal/vertical outlet Spare connecting piece not possible	BSK7000-129		527,00
Counterweights for non-self closing door	49097		60,50
Additional ring for raised cladding BSK 07 *	BSK7000-007		457,50
* Differences of colour between the height extension ring and other components of BSK/BSO are due to manufacturing process and cannot be excluded. These colour differences are no reason for a claim.			
EAS (see page 191)			2030,00
Reduced price for EAS without display			-192,50
Air flap adapter ø 125 mm for direct assembly motor at device	N003156		31,00
Socket blend stainless steel	BSK7000-137		217,00

Available variants:

Front variants			
Mounting frame, black 50 mm		SET211198	9594,00

Energy efficiency class A

Auslaufartikel



BSK 07 high left side

Set consists of:	Art.-Nr.	No.	Price
Eck 38/86/36, left side , lifting door, single glazing two-piece ceramic glass, outlet ø 200 mm		1	
Chamotte lining set Eck 38/86/36		1	
Support bearing BSK 07		1	
Thermal concrete cladding BSK 07		1	

Additional options			
Heat protective panels for BSK 07 side & back walls	BSK7000-131		374,50
Damper flap ø 200 mm with stainless steel handle	02460+10275		380,50
Smoke pipe adapter for horizontal/vertical outlet Spare connecting piece not possible	BSK7000-129		527,00
Counterweights for non-self closing door	49097		60,50
Additional ring for raised cladding BSK 07 *	BSK7000-007		457,50
* Differences of colour between the height extension ring and other components of BSK/BSO are due to manufacturing process and cannot be excluded. These colour differences are no reason for a claim.			
EAS (see page 191)			2030,00
Reduced price for EAS without display			-192,50
Socket blend stainless steel	BSK7000-137		217,00

Available variants:

Front variants			
Mounting frame, black 50 mm		SET211200	10183,50

Energy efficiency class A

flat

Tunnel

BSK

Eck

Panorama

Auslaufartikel



BSK 07 high right side

Set consists of:	Art.-Nr.	No.	Price
Eck 38/86/36, right side , lifting door, single glazing two-piece ceramic glass, outlet ø 200 mm		1	
Chamotte lining set Eck 38/86/36		1	
Support bearing BSK 07		1	
Thermal concrete cladding BSK 07		1	

Additional options			
Heat protective panels for BSK 07 side & back walls	BSK7000-131		374,50
Damper flap ø 200 mm with stainless steel handle	02460+10275		380,50
Smoke pipe adapter for horizontal/vertical outlet Spare connecting piece not possible	BSK7000-129		527,00
Counterweights for non-self closing door	49097		60,50
Additional ring for raised cladding BSK 07 *	BSK7000-007		457,50
* Differences of colour between the height extension ring and other components of BSK/BSO are due to manufacturing process and cannot be excluded. These colour differences are no reason for a claim.			
EAS (see page 191)			2030,00
Reduced price for EAS without display			-192,50
Socket blend stainless steel	BSK7000-137		217,00

Available variants:

Front variants			
Mounting frame, black 50 mm		SET211202	10183,50

Energy efficiency class A

Flat

Tunnel

BSK

Eck

Panorama



BSK 12 Corner fireplace waterbearing 42/57/30 left side, side-opening door

Set consists of:	Art.-Nr.	No.	Price
Corner fireplace waterbearing 42/57/30, left side, side-opening door two-piece ceramic glass, outlet ø 180 mm		1	
Chamotte lining set, bright, for Eck-Kamin 42/57/30		1	
Mounting frame		1	
Thermal concrete cladding BSK 12		1	

Additional options			
EOS (see page 191)			3677,50
EAS (see page 191)			2030,00
Reduced price for EAS without display			-192,50
Air flap adapter ø 125 mm for direct assembly motor at device	N003156		31,00
Set heat-protective panel	BSK12000-124		56,50
Additional ring for raised cladding BSK 12 *	BSK12000-007		386,00
* Differences of colour between the height extension ring and other components of BSK/BSO are due to manufacturing process and cannot be excluded. These colour differences are no reason for a claim.			
Socket blend stainless steel	BSK12000-017		217,00

Available variants:

Front variants			
Mounting frame, black 50 mm		SET213020	9577,00

Energy efficiency index A +

BSK 12 Corner fireplace waterbearing 42/57/30 right side, side-opening door



Set consists of:	Art.-Nr.	No.	Price
Corner fireplace waterbearing 42/57/30, right side, side-opening door two-piece ceramic glass, outlet ø 180 mm		1	
Chamotte lining set, bright, for Eck-Kamin 42/57/30		1	
Mounting frame		1	
Thermal concrete cladding BSK 12		1	

Additional options			
EOS (see page 191)			3677,50
EAS (see page 191)			2030,00
Reduced price for EAS without display			-192,50
Air flap adapter ø 125 mm for direct assembly motor at device	N003156		31,00
Set heat-protective panel	BSK12000-124		56,50
Additional ring for raised cladding BSK 12 *	BSK12000-007		386,00
* Differences of colour between the height extension ring and other components of BSK/BSO are due to manufacturing process and cannot be excluded. These colour differences are no reason for a claim.			
Socket blend stainless steel	BSK12000-017		217,00

Available variants:

Front variants			
Mounting frame, black 50 mm		SET213021	9577,00

Energy efficiency index A +

flat

Tunnel

BSK

Eck

Panorama

Auslaufartikel



BSK 12 Eck 42/57/30 left side, side-opening door

Set consists of:	Art.-Nr.	No.	Price
Eck 42/57/30, left side , side-opening door, single glazing two-piece ceramic glass, outlet ø 200 mm		1	
Chamotte lining set Eck 42/57/30 l		1	
Mounting frame		1	
Thermal concrete cladding BSK 12		1	

Additional options			
Heat protective panels for BSK 12 side & back walls	BSK12000-120		275,50
Damper flap ø 200 mm with stainless steel handle	02460+10275		380,50
Additional ring for raised cladding BSK 12 *	BSK12000-007		386,00
* Differences of colour between the height extension ring and other components of BSK/BSO are due to manufacturing process and cannot be excluded. These colour differences are no reason for a claim.			
EAS (see page 191)			2030,00
Reduced price for EAS without display			-192,50
Air flap adapter ø 125 mm for direct assembly motor at device	N003156		31,00
Socket blend stainless steel	BSK12000-017		217,00

Available variants:

Front variants			
Mounting frame, black 50 mm		SET213022	7487,50

Energy efficiency index A +

BSK 12 Eck 42/57/30 right side, side-opening door

Auslaufartikel



Set consists of:	Art.-Nr.	No.	Price
Eck 42/57/30, right side , side-opening door, single glazing two-piece ceramic glass, outlet ø 200 mm		1	
Chamotte lining set Eck 42/57/30 r		1	
Mounting frame		1	
Thermal concrete cladding BSK 12		1	

Additional options			
Heat protective panels for BSK 12 side & back walls	BSK12000-120		275,50
Damper flap ø 200 mm with stainless steel handle	02460+10275		380,50
Additional ring for raised cladding BSK 12 *	BSK12000-007		386,00
* Differences of colour between the height extension ring and other components of BSK/BSO are due to manufacturing process and cannot be excluded. These colour differences are no reason for a claim.			
EAS (see page 191)			2030,00
Reduced price for EAS without display			-192,50
Air flap adapter ø 125 mm for direct assembly motor at device	N003156		31,00
Socket blend stainless steel	BSK12000-017		217,00

Available variants:

Front variants			
Mounting frame, black 50 mm		SET213023	7487,50

flat

Tunnel

BSK

Eck

Panorama

Energy efficiency index A +

flat

Tunnel

BSK

Eck

Panorama



BSK 10

Set consists of:	Art.-Nr.	No.	Price
Panorama 42/42/42/42, outlet ø 200 mm		1	
Chamotte lining set Panorama 42/42/42/42		1	
Thermal concrete cladding BSK 10		1	

Additional options			
Heat protective panels for BSK 10 back wall	BSK10000-124		187,00
Damper flap ø 200 mm with stainless steel handle	02460+10275		380,50
Additional ring for raised cladding BSK 10 *	BSK10000-012		302,50
* Differences of colour between the height extension ring and other components of BSK/BSO are due to manufacturing process and cannot be excluded. These colour differences are no reason for a claim.			
Counterweights for non-self closing door	49097		60,50
Exchange connecting piece ø 180 mm	I058043		100,00
Socket blend stainless steel	BSK10000-128		217,00

Available variants:

Front variants			
Fire table, black		SET211404	10363,00

Energy efficiency class A

BSK 11



Set consists of:	Art.-Nr.	No.	Price
Panorama 70/25/40/25 outlet ø 200 mm		1	
Chamotte lining set Panorama 70/25/40/25		1	
Thermal concrete cladding BSK 11		1	

Additional options			
Heat protective panels for BSK 11 back wall	BSK11000-124		198,50
Damper flap ø 200 mm with stainless steel handle	02460+10275		380,50
Additional ring for raised cladding BSK 11 *	BSK11000-012		351,00
* Differences of colour between the height extension ring and other components of BSK/BSO are due to manufacturing process and cannot be excluded. These colour differences are no reason for a claim.			
Counterweights for non-self closing door	49097		60,50
Exchange connecting piece ø 180 mm	I058043		100,00
Socket blend stainless steel	BSK11000-129		217,00

Available variants:

Front variants			
Fire table, black		SET211406	11095,50

Energy efficiency index A +



BSK 5.1

Set consists of:	Art.-Nr.	No.	Price
Panorama 57/40/60/40 , outlet ø 200 mm		1	
Chamotte lining set Panorama 57/40/60/40		1	
Thermal concrete cladding BSK 5.1		1	

Additional options			
Heat protective panels for BSK 5.1 back wall	BSK5000-139		129,50
Smoke pipe adapter for horizontal/vertical outlet inclusive spare connecting piece	I009168		557,50
Damper flap ø 200 mm with stainless steel handle	02460+10275		380,50
Connection adapter ø 160 mm for changing the combustion air supply from side to rear	BSK5000-130		151,00
Additional ring for raised cladding BSK 5.1 *	BSK5000-014		405,50
* Differences of colour between the height extension ring and other components of BSK/BSO are due to manufacturing process and cannot be excluded. These colour differences are no reason for a claim.			
Counterweights for non-self closing door	49097		60,50
Exchange connectiong piece ø 180 mm	I019448		79,50
Exchange connectiong piece ø 250 mm	I019450		79,50
Socket blend stainless steel	BSK5000-133		217,00

Available variants:

Front variants			
Fire table, black		SET213069	11125,50

Energy efficiency class A



BSK 13

Set consists of:	Art.-Nr.	No.	Price
Panorama 51/66/50/66 , with support bracket and heat protective panel outlet ø 200 mm		1	
Combustion chamber lining Panorama 51/66/50/66		1	
Thermal concrete cladding BSK 13		1	

Additional options			
Damper flap ø 200 mm with stainless steel handle	02460+10275		380,50
Additional ring for raised cladding BSK 13 *	BSK13000-006		406,50
* Differences of colour between the height extension ring and other components of BSK/BSO are due to manufacturing process and cannot be excluded. These colour differences are no reason for a claim.			
Counterweights for non-self closing door		included/modification	
Exchange connectiong piece ø 180 mm	I019448		79,50
Exchange connectiong piece ø 250 mm	I019450		79,50
Socket blend stainless steel	BSK13000-120		89,00

Available variants:

Front variants			
Fire table black		SET213096	12939,50

Energy efficiency index A +

Glazing formats

Flat glazing



BSG 01

Door dimensions height x width in cm

from
page
264

Eck corners

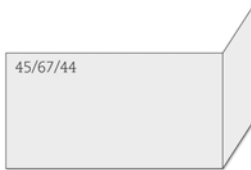

BSG 02

Door dimensions height x width x width in cm

from
page
268

flat

Eck

Door frame- Masonry stove kit systems



Door frame

Supplementary equipment

- EAS** Combustion controls with potential-free relay (without additional functions) consisting of display, 1 x flush-mount box, door switch, thermocouple & bus line, each 2 m long. Preassembled EAS/EOS components, door switch, thermocouple, motor box with transmission and \varnothing 125 mm air flap, flexible hose with adjustable clamps
- EOS** Combustion control with graphic touchscreen display and additional functions (differential temperature control, Moritz's flap control) consisting of: Display with control unit, 2 x flush-mount box, door switch, thermocouple, bus and connecting line, each 2 m long, 4 x water sensors with immersion sleeve and 2x extension cable 3 m. Preassembled EOS components: door switch, thermocouple, motor box with transmission and \varnothing 125 mm air flap, flexible hose with adjustable clamps



BSG 01 low with MSS heat storage set standing next

Set consists of:	Art.-Nr.	No.	Price
GOT 51/67-ZL side-opening door, single glazing		1	
Door frame		1	
GOF 66x42		1	
MSS elbow 90°		2	
MSS heat storage module 20 cm		2	
MSS heat storage module 10 cm		2	
MSS elbow 90° with opening top		1	
MSS heat storage module 20 cm with opening		1	
MSS bypass 40		1	
MSS elbow 90° with cleanout top		2	
MSS elbow 90° with lining, double-layered		1	
MSS base plate 75		3	
MSSI insulating block 30x30 cm		3	
MSS steel tape ring		10	
MSS glue Thermofix 1000 1 kg		2	
MSS connecting block		1	
Thermal concrete cladding BSG 01 (MSS heat storage set standing next)		1	
Inlet adapter		1	
Outlet adapter		1	
Mounting kit (with two clamps and endless tape)		2	
MSS handle with rotating part		1	

Additional options

Double glazing			375,50
Conversion kit right hinge door	02380		173,00

Available variants:

Front variants:			
Door frame, black		SET211476	12583,50

Energy efficiency index A +

BSG 01 low with MSS heat storage set standing next + EAS



Set consists of:	Art.-Nr.	No.	Price
GOT 51/67-ZLside-opening door, single glazing		1	
Door frame		1	
GOF 66x42		1	
MSS elbow 90°		2	
MSS heat storage module 20 cm		2	
MSS heat storage module 10 cm		2	
MSS elbow 90° with opening top		1	
MSS heat storage module 20 cm with opening		1	
MSS bypass 40		1	
MSS elbow 90° with cleanout top		2	
MSS elbow 90° with lining, double-layered		1	
MSS base plate 75		3	
MSSI insulating block 30x30 cm		3	
MSS steel tape ring		10	
MSS glue Thermofix 1000 1 kg		2	
MSS connecting block		1	
Thermal concrete cladding BSG 01 (MSS heat storage set standing next)		1	
Inlet adapter		1	
Outlet adapter		1	
Mounting kit (with two clamps and endless tape)		2	
EAS (see page 191)		1	
Mounting box		1	
Door switch wiring 3 lm		1	
Thermocouple wiring 3 lm		1	
Bus wiring 3 lm		1	
MSS handle with rotating part		1	

Additional options

Reduced price for EAS without display			-192,50
Double glazing			375,50
Conversion kit right hinge door	02380		173,00

Available variants:

Front variants:			
Door frame, black		SET211478	14646,50

Energy efficiency index A +



BSG 01 high with MSS heat storage set standing on top

Set consists of:	Art.-Nr.	No.	Price
GOT 51/67-ZL side-opening door, single glazing		1	
Door frame		1	
GOF 66x42		1	
MSS elbow 90° with lining, double-layered		1	
MSS elbow 90°		4	
MSS outlet block ø 180 with sealing		1	
MSS heat storage module 10 cm with damper flap		1	
MSS elbow 90° with cleanout top		1	
MSS elbow 90° with cleanout left		1	
MSS heat storage module 20 cm		2	
MSS steel tape ring		11	
MSS glue Thermofix 1000 1 kg		2	
MSS connecting block		1	
Thermal concrete cladding BSG 01 (high)		1	
MSS handle with rotating part		1	

Additional options

Double glazing			375,50
Conversion kit right hinge door	02380		173,00

Available variants:

Front variants:			
Door frame, black		SET211480	11102,50

Energy efficiency index A +

BSG 01 high with MSS heat storage set standing on top + EAS



Set consists of:	Art.-Nr.	No.	Price
GOT 51/67-ZL side-opening door, single glazing		1	
Door frame		1	
GOF 66x42		1	
MSS elbow 90° with lining, double-layered		1	
MSS elbow 90°		4	
MSS outlet block ø180		1	
MSS heat storage module 10 cm		1	
MSS elbow 90° with cleanout top		1	
MSS elbow 90° with cleanout left		1	
MSS heat storage module 20 cm		2	
MSS steel tape ring		11	
MSS glue Thermofix 1000 1 kg		2	
MSS connecting block		1	
Thermal concrete cladding BSG 01 (high)		1	
EAS (see page 191)		1	
Mounting box		1	
Door switch wiring 3 lm		1	
Thermocouple wiring 3 lm		1	
Bus wiring 3 lm		1	
MSS handle with rotating part		1	

Additional options			
Reduced price for EAS without display			-192,50
Double glazing			375,50
Conversion kit right hinge door	02380		173,00

Available variants:

Front variants:			
Door frame, black		SET211482	13166,00

Energy efficiency index A +

BSG 02 low left side with MSS heat storage set standing next



flat

Set consists of:	Art.-Nr.	No.	Price
GOT 45/67/44-ZL L, single glazing two-piece ceramic glass		1	
Door frame		1	
GOF 50x35		1	
MSS elbow 90°		2	
MSS heat storage module 20 cm		2	
MSS heat storage module 10 cm		2	
MSS elbow 90° with opening top		1	
MSS heat storage module 20 cm with opening		1	
MSS bypass 40		1	
MSS elbow 90° with cleanout top		2	
MSS elbow 90° with lining, double-layered		1	
MSS base plate 75		3	
MSSI insulating block 30x30 cm		3	
MSS steel tape ring		10	
MSS glue Thermofix 1000 1 kg		2	
MSS connecting block		1	
Thermal concrete cladding BSG 02 (MSS heat storage set standing next)		1	
Inlet adapter		1	
Outlet adapter		1	
Mounting kit (with two clamps and endless tape)		2	
MSS handle with rotating part		1	

Additional options

MSS connecting block backwall	G015107		0,00
instead MSS connecting block / GOF short side (G023205) the MSS connecting block backwall (G015107) will be delivered			

Available variants:

Front variants:			
Door frame, black		SET211488	14014,50

Energy efficiency index A +

BSG 02 low left side with MSS heat storage set standing next + EAS



Set consists of:	Art.-Nr.	No.	Price
GOT 45/67/44-ZL L, single glazing two-piece ceramic glass		1	
Door frame		1	
GOF 50x35		1	
MSS elbow 90°		2	
MSS heat storage module 20 cm		2	
MSS heat storage module 10 cm		2	
MSS elbow 90° with opening top		1	
MSS heat storage module 20 cm with opening		1	
MSS bypass 40		1	
MSS elbow 90° with cleanout top		2	
MSS elbow 90° with lining, double-layered		1	
MSS base plate 75		3	
MSSI insulating block 30x30 cm		3	
MSS steel tape ring		10	
MSS glue Thermofix 1000 1 kg		2	
MSS connecting block		1	
Thermal concrete cladding BSG 02 (MSS heat storage set standing next)		1	
Inlet adapter		1	
Outlet adapter		1	
Mounting kit (with two clamps and endless tape)		2	
EAS (see page 191)		1	
Mounting box		1	
Door switch wiring 3 lm		1	
Thermocouple wiring 3 lm		1	
Bus wiring 3 lm		1	
MSS handle with rotating part		1	

Additional options

MSS connecting block backwall	G015107		0,00
instead MSS connecting block / GOF short side (G023205) the MSS connecting block backwall (G015107) will be delivered			
Reduced price for EAS without display			-192,50

Available variants:

Front variants:			
Door frame, black		SET211490	16078,00

Energy efficiency index A +

BSG 02 low right side with MSS heat storage set standing next



flat

Set consists of:	Art.-Nr.	No.	Price
GOT 45/67/44-ZL R , single glazing two-piece ceramic glass		1	
Door frame		1	
GOF 50x35		1	
MSS elbow 90°		2	
MSS heat storage module 20 cm		2	
MSS heat storage module 10 cm		2	
MSS elbow 90° with opening top		1	
MSS heat storage module 20 cm with opening		1	
MSS bypass 40		1	
MSS elbow 90° with cleanout top		2	
MSS elbow 90° with lining, double-layered		1	
MSS base plate 75		3	
MSSI insulating block 30x30 cm		3	
MSS steel tape ring		10	
MSS glue Thermofix 1000 1 kg		2	
MSS connecting block		1	
Thermal concrete cladding BSG 02 (MSS heat storage set standing next)		1	
Inlet adapter		1	
Outlet adapter		1	
Mounting kit (with two clamps and endless tape)		2	
MSS handle with rotating part		1	

Additional options

MSS connecting block backwall	G015107		0,00
instead MSS connecting block / GOF short side (G023204) the MSS connecting block backwall (G015107) will be delivered			

Available variants:

Front variants:			
Door frame, black		SET211484	14014,50

Energy efficiency index A +

BSG 02 low right side with MSS heat storage set standing next + EAS



Set consists of:	Art.-Nr.	No.	Price
GOT 45/67/44-ZL R, single glazing two-piece ceramic glass		1	
Door frame		1	
GOF 50x35		1	
MSS elbow 90°		2	
MSS heat storage module 20 cm		2	
MSS heat storage module 10 cm		2	
MSS elbow 90° with opening top		1	
MSS heat storage module 20 cm with opening		1	
MSS bypass 40		1	
MSS elbow 90° with cleanout top		2	
MSS elbow 90° with lining, double-layered		1	
MSS base plate 75		3	
MSSI insulating block 30x30 cm		3	
MSS steel tape ring		10	
MSS glue Thermofix 1000 1 kg		2	
MSS connecting block		1	
Thermal concrete cladding BSG 02 (MSS heat storage set standing next)		1	
Inlet adapter		1	
Outlet adapter		1	
Mounting kit (with two clamps and endless tape)		2	
EAS (see page 191)		1	
Mounting box		1	
Door switch wiring 3 lm		1	
Thermocouple wiring 3 lm		1	
Bus wiring 3 lm		1	
MSS handle with rotating part		1	

Additional options

MSS connecting block backwall	G015107		0,00
instead MSS connecting block / GOF short side (G023204) the MSS connecting block backwall (G015107) will be delivered			
Reduced price for EAS without display			-192,50

Available variants:

Front variants:			
Door frame, black		SET211486	16078,00

Energy efficiency index A +



BSG 02 high left side with MSS heat storage set standing on top

Set consists of:	Art.-Nr.	No.	Price
GOT 45/67/44-ZL L , single glazing two-piece ceramic glass		1	
Door frame		1	
GOF 50x35		1	
MSS elbow 90° with lining, double-layered		1	
MSS elbow 90°		3	
MSS outlet block ø180		1	
MSS elbow 90°		2	
MSS heat storage module 10 cm		1	
MSS steel tape ring		10	
MSS heat storage module with lining 20 cm, double-layered		1	
MSS base plate 100		4	
MSS elbow 90°		1	
MSSI insulating block 20x30 cm		2	
MSSI insulating block 30x30 cm		1	
MSS glue Thermofix 1000 1 kg		2	
Thermal concrete cladding BSG 02 (high)		1	
MSS handle with rotating part		1	

Available variants:

Front variants:			
Door frame, black		SET211496	12658,00

Energy efficiency index A +

BSG 02 high left side with MSS heat storage set standing on top + EAS



Set consists of:	Art.-Nr.	No.	Price
GOT 45/67/44-ZL L, single glazing two-piece ceramic glass		1	
Door frame		1	
GOF 50x35		1	
MSS elbow 90° with lining, double-layered		1	
MSS elbow 90°		3	
MSS outlet block ø180		1	
MSS elbow 90°		2	
MSS heat storage module 10 cm		1	
MSS steel tape ring		10	
MSS heat storage module with lining 20 cm, double-layered		1	
MSS base plate 100		4	
MSS elbow 90°		1	
MSSI insulating block 20x30 cm		2	
MSSI insulating block 30x30 cm		1	
MSS glue Thermofix 1000 1 kg		2	
Thermal concrete cladding BSG 02 (high)		1	
EAS (see page 191)		1	
Mounting box		1	
Door switch wiring 3 lm		1	
Thermocouple wiring 3 lm		1	
Bus wiring 3 lm		1	
MSS handle with rotating part		1	

Additional options

Reduced price for EAS without display			-192,50
---------------------------------------	--	--	---------

Available variants:

Front variants:			
Door frame, black		SET211498	14721,00

Energy efficiency index A +



BSG 02 high right side with MSS heat storage set standing on top

Set consists of:	Art.-Nr.	No.	Price
GOT 45/67/44-ZL R, single glazing two-piece ceramic glass		1	
Door frame		1	
GOF 50x35		1	
MSS elbow 90° with lining, double-layered		1	
MSS elbow 90°		3	
MSS outlet block ø180		1	
MSS elbow 90°		2	
MSS heat storage module 10 cm		1	
MSS steel tape ring		10	
MSS heat storage module with lining 20 cm, double-layered		1	
MSS base plate 100		4	
MSS elbow 90°		1	
MSSI insulating block 20x30 cm		2	
MSSI insulating block 30x30 cm		1	
MSS glue Thermofix 1000 1 kg		2	
Thermal concrete cladding BSG 02 (high)		1	
MSS handle with rotating part		1	

Available variants:

Front variants:			
Door frame, black		SET211492	12658,00

Energy efficiency index A +

BSG 02 high right side with MSS heat storage set standing on top + EAS



Set consists of:	Art.-Nr.	No.	Price
GOT 45/67/44-ZL R, single glazing two-piece ceramic glass		1	
Door frame		1	
GOF 50x35		1	
MSS elbow 90° with lining, double-layered		1	
MSS elbow 90°		3	
MSS outlet block ø180		1	
MSS elbow 90°		2	
MSS heat storage module 10 cm		1	
MSS steel tape ring		10	
MSS heat storage module with lining 20 cm, double-layered		1	
MSS base plate 100		4	
MSS elbow 90°		1	
MSSI insulating block 20x30 cm		2	
MSSI insulating block 30x30 cm		1	
MSS glue Thermofix 1000 1 kg		2	
Thermal concrete cladding BSG 02 (high)		1	
EAS (see page 191)		1	
Mounting box		1	
Door switch wiring 3 lm		1	
Thermocouple wiring 3 lm		1	
Bus wiring 3 lm		1	
MSS handle with rotating part		1	

Additional options

Reduced price for EAS without display			-192,50
---------------------------------------	--	--	---------

Available variants:

Front variants:			
Door frame, black		SET211494	14721,00

Energy efficiency index A +

Glazing formats

Flat glazing



HKD 7

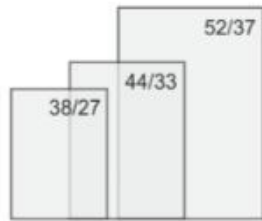

HKD Glass panes

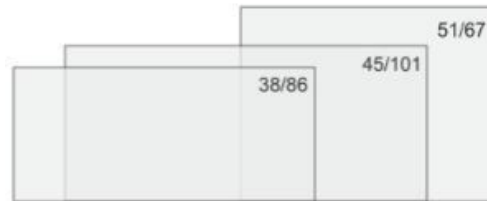

KK-Glass panes

Door dimensions height x width in cm

from page 278

Tunnel formats



HKD 7

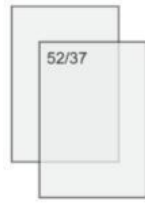

HKD 2.2.
HKD 2.2 XL

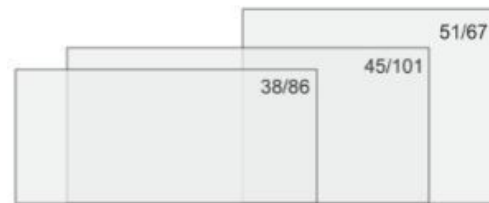

KK-Glass panes

Door dimensions height x width in cm

from page 296

Eck corners

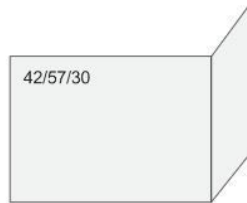

KK Glass panes



Door dimensions height x width in cm

from page 310

Door frame - mounting frame HKD



Door frame



Mounting frame



Cast iron frame



Steel front plate
42 x 79 cm



Cast iron front plate
42 x 79 cm



Steel front plate
48 x 83 cm



Door frame
R = 330



Mounting frame
R = 380

Door frame - mounting frame Fireplace waterbearing



Door frame



Mounting frame 50 mm



Mounting frame 70 mm

Supplementary equipment

- EAS** Combustion controls with potential-free relay (without additional functions) consisting of display, 1 x flush-mount box, door switch, thermocouple & bus line, each 2 m long. Preassembled EAS/EOS components, door switch, thermocouple, motor box with transmission and \varnothing 125 mm air flap, flexible hose with adjustable clamps
- EOS** Combustion control with graphic touchscreen display and additional functions (differential temperature control, Moritz's flap control) consisting of: Display with control unit, 2 x flush-mount box, door switch, thermocouple, bus and connecting line, each 2 m long, 4 x water sensors with immersion sleeve and 2x extension cable 3 m. Preassembled EOS components: door switch, thermocouple, motor box with transmission and \varnothing 125 mm air flap, flexible hose with adjustable clamps



HKD 2.6.k SK side-opening door flat glass

Set consists of:	Art.-Nr.	No.	Price
HKD 2.6 k SK , Double glazing		1	
Door frame, mounting frame, or front plate		1	
Inner lining set for HKD 2.6 k SK		1	
Upper lining HKD 2.6 k SK		1	
Support bearing HKD 2.6 k SK		1	

Additional options			
EAS (see page 277)			2030,00
Reduced price for EAS without display			-192,50
EOS (see page 277)			3677,50
Door handle black	02056-01		117,00

Available variants:

Front variants:			
Door frame, black		SET209179	6827,50
Cast iron frame		SET209181	6845,00

Energy efficiency index A +

HKD 2.6.k SK cast iron doors



Set consists of:	Art.-Nr.	No.	Price
HKD 2.6 k SK , cast iron doors		1	
Cast iron frame, front plate		1	
Inner lining set for HKD 2.6 k SK		1	
Upper lining HKD 2.6 k SK		1	
Support bearing HKD 2.6 k SK		1	

Additional options			
EAS (see page 277)			2030,00
Reduced price for EAS without display			-192,50
EOS (see page 277)			3677,50
Door handle black	02056-01		117,00

Available variants:

Front variants:			
Cast iron frame		SET209185	6845,00

Energy efficiency index A +







B7 side-opening door flat glass

Set consists of:	Art.-Nr.	No.	Price
B7 with doors HKD 6.1 DF, single glazing		1	
Door frame / Cast iron frame / front plate		1	
Inner lining set for B7		1	
Upper lining B7		1	
Support bearing B7		1	

Additional options			
EAS (see page 277)			2030,00
Reduced price for EAS without display			-192,50
EOS (see page 277)			3677,50
Double glazing			0,00
Door handle black	02056-01		117,00

Available variants:

Front variants:				
Door frame, black		SET209045		6122,50
Door frame, stainless steel		SET209046		6199,50
Cast iron frame		SET209047		6140,00
Steel front plate, black 48 x 83 cm		SET209048		6357,50
Cast iron front plate 48 x 83 cm		SET209053		6314,00

Energy efficiency index A +



B7 side-opening door cast iron doors



Set consists of:	Art.-Nr.	No.	Price
B7 with doors HKD 6.1, DF, cast iron doors		1	
Cast iron frame / front plate		1	
Inner lining set for B7		1	
Upper lining B7		1	
Support bearing B7		1	

Additional options			
EAS (see page 277)			2030,00
Reduced price for EAS without display			-192,50
EOS (see page 277)			3677,50
Door handle black	02056-01		117,00

Available variants:

Front variants:				
Cast iron frame		SET209058		6140,00
Cast iron front plate 48 x 83 cm		SET209059		6314,00

Energy efficiency index A +







B8 side-opening door flat glass

Set consists of:	Art.-Nr.	No.	Price
B8 with doors , HKD 6.1 DF, single glazing		1	
Door frame / Cast iron frame / front plate		1	
Inner lining set for B8		1	
Upper lining B8		1	
Support bearing B8		1	

Additional options			
EAS (see page 277)			2030,00
Reduced price for EAS without display			-192,50
EOS (see page 277)			3677,50
Double glazing			0,00
Door handle black	02056-01		117,00

Available variants:

Front variants:				
Door frame, black		SET209060		6691,00
Door frame, stainless steel		SET209061		6768,50
Cast iron frame		SET209062		6708,50
Steel front plate, black 48 x 83 cm		SET209063		6926,50
Cast iron front plate 48 x 83 cm		SET209064		6883,00

Energy efficiency index A +

B8 side-opening door cast iron doors



Set consists of:	Art.-Nr.	No.	Price
B8 with doors , HKD 6.1 DF, cast iron doors		1	
Cast iron frame / front plate		1	
Inner lining set for B8		1	
Upper lining B8		1	
Support bearing B8		1	

Additional options			
EAS (see page 277)			2030,00
Reduced price for EAS without display			-192,50
EOS (see page 277)			3677,50
Door handle black	02056-01		117,00

Available variants:

Front variants:				
Cast iron frame		SET209070		6708,50
Cast iron front plate 48 x 83 cm		SET209071		6883,00

Energy efficiency index A +







B4 side-opening door flat glass



Set consists of:	Art.-Nr.	No.	Price
B4 with doors , HKD 4.1 DF, single glazing, with cleaning mechanism		1	
Door frame, mounting frame, or front plate		1	
Inner lining set for B4		1	
Upper lining B4		1	
Support bearing B4		1	
side/rear outlet		1	







Additional options			
EAS (see page277)			2030,00
Reduced price for EAS without display			-192,50
EOS (see page277)			3677,50
Smoke pipe connection with cover, top outlet ø 180 mm for Kompaktkessel B4			0,00
Conversion kit/ extension for cleaning on front	11726		259,50
Conversion kit/extension for cleaning on side	11727		204,00
Conversion kit for cleaning on top including push-in handle	BSK2000-201		272,50
Double glazing			0,00
Door handle black	02056-01		117,00

Available variants:







Front variants:			
Door frame, black		SET209072	10021,50
Door frame, stainless steel		SET209073	10123,00
Mounting frame, black		SET208312	10073,50
Mounting frame, stainless steel		SET208313	10168,00
Cast iron frame		SET209074	10051,50
Steel front plate, black 48 x 83 cm		SET209075	10220,50
Cast iron front plate 48 x 83 cm		SET209082	10151,50

Smoke hood variants:



Cast iron hot air hood ø 180 mm	R014022-03	1	
Front variants:			
Door frame, black		SET213106	10393,50
Door frame, stainless steel		SET213107	10495,00
Mounting frame, black		SET213108	10445,50
Mounting frame, stainless steel		SET213109	10540,00
Cast iron frame		SET213110	10423,50
Steel front plate, black 48 x 83 cm		SET213111	10592,50
Cast iron front plate 48 x 83 cm		SET213112	10523,50



+ Modular accumulator MAS 440 double-layered		R009042	5	
Cast iron dome MAS ø 180		R009095-01	1	
Mounting ring		10077	1	
Front variants:				
Door frame, black		SET213113		11985,50
Door frame, stainless steel		SET213114		12087,00
Mounting frame, black		SET213115		12037,50
Mounting frame, stainless steel		SET213116		12131,50
Cast iron frame		SET213117		12015,50
Steel front plate, black 48 x 83 cm		SET213118		12184,50
Cast iron front plate 48 x 83 cm		SET213119		12115,50

Energy efficiency index A +



B4 side-opening door cast iron doors

Set consists of:	Art.-Nr.	No.	Price
B4 with doors HKD 4.1, cast iron doors, with cleaning mechanism		1	
Cast iron frame, front plate		1	
Inner lining set for B4		1	
Upper lining B4		1	
Support bearing B4		1	
side/rear outlet		1	



Additional options			
EAS (see page277)			2030,00
Reduced price for EAS without display			-192,50
EOS (see page277)			3677,50
Smoke pipe connection with cover, top outlet ø 180 mm for Kompaktkessel B4			0,00
Conversion kit/ extension for cleaning on front	11726		259,50
Conversion kit/extension for cleaning on side	11727		204,00
Conversion kit for cleaning on top including push-in handle	BSK2000-201		272,50
Door handle black	02056-01		117,00

Available variants:



Front variants:			
Cast iron frame		SET209087	10051,50
Cast iron front plate 48 x 83 cm		SET209088	10151,50

Smoke hood variants



Cast iron hot air hood ø 180 mm	R014022-03	1	
Front variants:			
Cast iron frame		SET213120	10423,50
Cast iron front plate 48 x 83 cm		SET213121	10523,50



+ Modular accumulator MAS 440 double-layered	R009042	5	
Cast iron dome MAS ø 180	R009095-01	1	
Mounting ring	10077	1	
Front variants:			
Cast iron frame		SET213122	12015,50
Cast iron front plate 48 x 83 cm		SET213123	12115,50

Energy efficiency index A +



HKD 2.2 k SK side-opening door flat glass

Set consists of:	Art.-Nr.	No.	Price
HKD 2.2 k SK, Side-opening door, flat, single glazing		1	
Door frame, mounting frame, or front plate		1	
Inner lining set for HKD 2.2 k SK		1	
Upper lining HKD 2.2 k SK		1	
Support bearing HKD 2.2 k SK		1	

Additional options			
EAS (see page 277)			2030,00
Reduced price for EAS without display			-192,50
EOS (see page 277)			3677,50
Double glazing			208,00
Door handle black	02056-01		117,00
Option front with door HKD 2.2 round glass			Price on request

Available variants:

Front variants:				
Door frame, black		SET209165		6746,50
Door frame, stainless steel		SET209166		6806,00
Mounting frame, black		SET209167		6877,50
Mounting frame, stainless steel		SET209168		7020,50
Cast iron front plate 48 x 83 cm		SET209170		6915,50
Steel front plate 48 x 83 cm		SET209171		6882,00

Energy efficiency index A +

HKD 2.2 SK + EAS (with Moritz's flap mode)

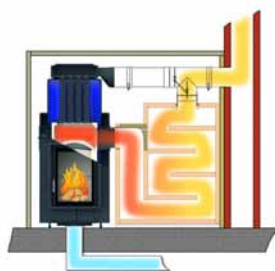

Heat storage mode
with Moritz's flap

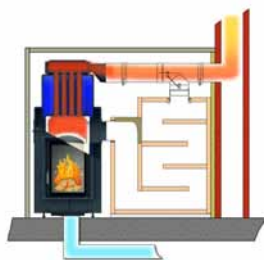

Boiler operation
with Moritz's flap

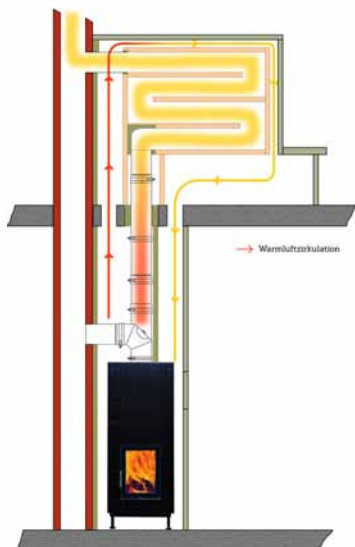

Additional option: smoke
pipe connection kit in-
stead Moritz's flap

Set consists of:	Art.-Nr.	No.	Price
HKD 2.2 SK DF side-opening door flat glass, single glazed for EAS/EOS, with cleaning mechanism		1	
Door frame or mounting frame		1	
Inner lining set for HKD 2.2 SK flat/round		1	
Upper lining HKD 2.2 SK		1	
Moritz's smoke valve		1	
EAS (see page 277)		1	
Mounting box		1	
Door switch wiring 2 lm		1	
Thermocouple wiring 2 lm		1	
Bus wiring 2 lm		1	
Connecting piece for side/rear smoke outlet ø 180 mm / Boiler		1	
Connecting piece for side/rear smoke outlet ø 180 mm / Reheater		1	

Additional options			
Add. charge EOS ¹			1648,00
Reduced price for EAS without display			-192,50
Smoke pipe outlet on top ø 180 mm	W043140		0,00
Smoke valve actuator with insulation (10338 and 10329) ²			933,00
Conversion kit/ extension for cleaning on front	11726		259,50
Conversion kit/extension for cleaning on side	W043135		249,00
Double glazing			208,00
Door handle black	02056-01		117,00
Front option with HKD 2.6 door (optional double glass, simple glass or control window)			Price on request
Option front with door HKD 2.2 round glass			Price on request

Available variants:

Front variants:			
Door frame, black		SET209400	13347,00
Door frame, stainless steel		SET209401	13407,00
Mounting frame, black		SET209402	13478,50
Mounting frame, stainless steel		SET209403	13621,50

¹compared to EAS: EOS control & display unit, second flush-mount box, connecting cable for control & display unit 2m long, 4x water temperature sensor with sleeve and 2x extension cable 3m long.

²possible only in combination with EOS.

Energy efficiency index A +



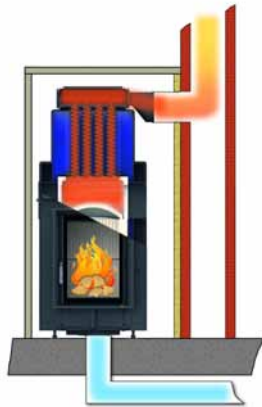

Boiler operation with direct connection

HKD 2.2 SK with direct connection + EAS

Set consists of:	Art.-Nr.	No.	Price
HKD 2.2 SK DF side-opening door flat glass, single glazed for EAS/EOS, with cleaning mechanism		1	
Door frame or mounting frame		1	
Inner lining set for HKD 2.2 SK flat/round		1	
Upper lining HKD 2.2 SK		1	
EAS (see page 277)		1	
Mounting box		1	
Door switch wiring 2 lm		1	
Thermocouple wiring 2 lm		1	
Bus wiring 2 lm		1	
Connecting piece for side/rear smoke outlet ø 180 mm		1	

Additional options			
Add. charge EOS ¹			1648,00
Reduced price for EAS without display			-192,50
Smoke pipe outlet on top ø 180 mm	W043140		0,00
Conversion kit/ extension for cleaning on front	11726		259,50
Conversion kit/extension for cleaning on side	W043135		249,00
Double glazing			208,00
Door handle black	02056-01		117,00
Front option with HKD 2.6 door (optional double glass, simple glass or control window)			Price on request
Option front with door HKD 2.2 round glass			Price on request

Available variants:

Front variants:			
Door frame, black		SET209414	12753,50
Door frame, stainless steel		SET209415	12813,50
Mounting frame, black		SET209416	12885,00
Mounting frame, stainless steel		SET209417	13028,00

¹compared to EAS: EOS control & display unit, second flush-mount box, connecting cable for control & display unit 2m long, 4x water temperature sensor with sleeve and 2x extension cable 3m long.

Energy efficiency index A +

HKD 2.2 XL SK/h + EAS (with Moritz's flap mode)



Heat storage mode with Moritz's flap



Boiler operation with Moritz's flap

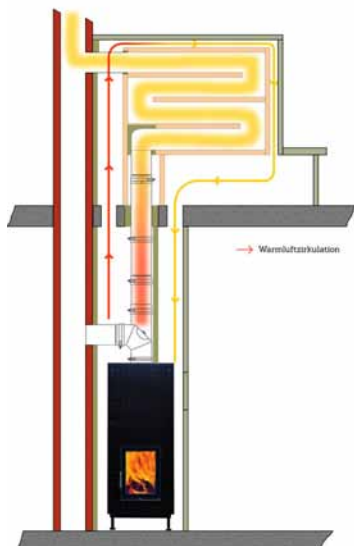

Additional option: smoke pipe connection kit instead Moritz's flap

Set consists of:	Art.-Nr.	No.	Price
HKD 2.2 XL SK/h DF side-opening door flat glass , single glazed for EAS/EOS with cleaning mechanism		1	
Door frame or mounting frame		1	
Inner lining set for HKD 2.2 XL SK /h flat/round		1	
Upper lining HKD 2.2 XL SK /h		1	
Moritz's smoke valve		1	
EAS (see page 277)		1	
Mounting box		1	
Door switch wiring 2 lm		1	
Thermocouple wiring 2 lm		1	
Bus wiring 2 lm		1	
Connecting piece for side/rear smoke outlet ø 180 mm / Boiler		1	
Connecting piece for side/rear smoke outlet ø 180 mm / Reheater		1	

Additional options			
Add. charge EOS ¹			1648,00
Reduced price for EAS without display			-192,50
Smoke pipe outlet on top ø 180 mm	W043140		0,00
Smoke valve actuator with insulation (10338 and 10329) ²			933,00
Conversion kit/ extension for cleaning on front	11726		259,50
Conversion kit/extension for cleaning on side	W043135		249,00
Double glazing			208,00
Door handle black	02056-01		117,00
Front option with HKD 2.6 door (optional double glass, simple glass or control window)			Price on request
Option front with door HKD 2.2 round glass			Price on request

Available variants:

Front variants:			
Door frame, black		SET209428	13816,00
Door frame, stainless steel		SET209429	13875,50
Mounting frame, black		SET209430	13947,00
Mounting frame, stainless steel		SET209431	14090,00

¹compared to EAS: EOS control & display unit, second flush-mount box, connecting cable for control & display unit 2m long, 4x water temperature sensor with sleeve and 2x extension cable 3m long.

²possible only in combination with EOS.

Energy efficiency index A +



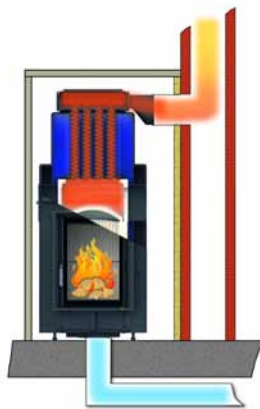

Boiler operation with direct connection

HKD 2.2 XL SK/h with direct connection + EAS

Set consists of:	Art.-Nr.	No.	Price
HKD 2.2 XL SK/h DF side-opening door flat glass , single glazed for EAS/EOS with cleaning mechanism		1	
Door frame or mounting frame		1	
Inner lining set for HKD 2.2 XL SK /h flat/round		1	
Upper lining HKD 2.2 XL SK /h		1	
EAS (see page 277)		1	
Mounting box		1	
Door switch wiring 2 lm		1	
Thermocouple wiring 2 lm		1	
Bus wiring 2 lm		1	
Connecting piece for side/rear smoke outlet ø 180 mm		1	

Additional options			
Add. charge EOS ¹			1648,00
Reduced price for EAS without display			-192,50
Smoke pipe outlet on top ø 180 mm	W043140		0,00
Conversion kit/ extension for cleaning on front	11726		259,50
Conversion kit/extension for cleaning on side	W043135		249,00
Double glazing			208,00
Door handle black	02056-01		117,00
Front option with HKD 2.6 door (optional double glass, simple glass or control window)			Price on request
Option front with door HKD 2.2 round glass			Price on request

Available variants:

Front variants:			
Door frame, black		SET209433	13222,50
Door frame, stainless steel		SET209434	13282,00
Mounting frame, black		SET209435	13353,50
Mounting frame, stainless steel		SET209436	13496,50

¹compared to EAS: EOS control & display unit, second flush-mount box, connecting cable for control & display unit 2m long, 4x water temperature sensor with sleeve and 2x extension cable 3m long.

Energy efficiency index A +

HKD 7 SK + EAS (with Moritz's flap mode)

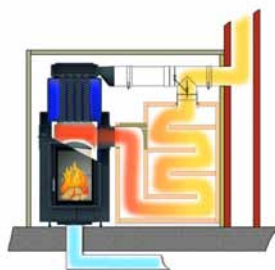

Heat storage mode
with Moritz's flap



Boiler operation
with Moritz's flap

Set consists of:	Art.-Nr.	No.	Price
HKD 7 SK DF side-opening door flat glass , single glazed for EAS/EOS, with cleaning mechanism		1	
Door frame or mounting frame		1	
Inner lining set for HKD 7 SK		1	
Upper lining HKD 7 SK		1	
Moritz's smoke valve		1	
EAS (see page 277)		1	
Mounting box		1	
Door switch wiring 2 lm		1	
Thermocouple wiring 2 lm		1	
Bus wiring 2 lm		1	
Connecting piece for side/rear smoke outlet ø 180 mm / Boiler		1	
Connecting piece for side/rear smoke outlet ø 180 mm / Reheater		1	

Additional options			
Add. charge EOS ¹			1648,00
Reduced price for EAS without display			-192,50
Smoke pipe outlet on top ø 180 mm	W043140		0,00
Smoke valve actuator with insulation (10338 and 10329) ²			933,00
Conversion kit/ extension for cleaning on front	11726		259,50
Conversion kit/extension for cleaning on side	W043135		249,00
Conversion kit for cleaning on top including push-in handle	BSO5000-123		275,50
Double glazing			208,00
Door handle black	02056-01		117,00

Available variants:

Front variants:			
Door frame, black		SET213002	15068,50
Mounting frame, black		SET213003	15050,00

¹compared to EAS: EOS control & display unit, second flush-mount box, connecting cable for control & display unit 2m long, 4x water temperature sensor with sleeve and 2x extension cable 3m long.

²possible only in combination with EOS.

Energy efficiency index A +

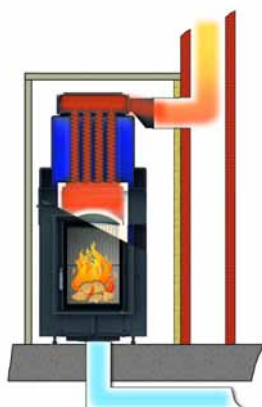

Boiler operation with direct connection

HKD 7 SK with direct connection + EAS

Set consists of:	Art.-Nr.	No.	Price
HKD 7 SK DF side-opening door flat glass, single glazed for EAS/EOS, with cleaning mechanism		1	
Door frame or mounting frame		1	
Inner lining set for HKD 7 SK		1	
Upper lining HKD 7 SK		1	
EAS (see page 277)		1	
Mounting box		1	
Door switch wiring 2 lm		1	
Thermocouple wiring 2 lm		1	
Bus wiring 2 lm		1	
Connecting piece for side/rear smoke outlet ø 180 mm		1	

Additional options			
Add. charge EOS ¹			1648,00
Reduced price for EAS without display			-192,50
Smoke pipe outlet on top ø 180 mm	W043140		0,00
Conversion kit/ extension for cleaning on front	11726		259,50
Conversion kit/extension for cleaning on side	W043135		249,00
Conversion kit for cleaning on top including push-in handle	BSO5000-123		275,50
Double glazing			208,00
Door handle black	02056-01		117,00

Available variants:

Front variants:			
Door frame, black		SET213004	14475,00
Mounting frame, black		SET213005	14456,50

¹compared to EAS: EOS control & display unit, second flush-mount box, connecting cable for control & display unit 2m long, 4x water temperature sensor with sleeve and 2x extension cable 3m long.

Energy efficiency index A +

Stil-Kamin 51/67 side-opening door, single glazing, with top-mount boiler

Auslaufartikel



Set consists of:	Art.-Nr.	No.	Price
Stil-Kamin 51/67 , side-opening door, single glazing		1	
Door frame		1	
Chamotte lining set Stil 51/67		1	
ISO upper lining / deflection		1	
Top-mount boiler		1	

Additional options			
EAS (see page 277)			2030,00
Reduced price for EAS without display			-192,50
EOS (see page 277)			3677,50
Smoke pipe adapter for horizontal outlet	BSK7000-129		527,00
Exchange connectiong pieceø 180 mm	I058043		100,00
Double glazing			375,50

Available variants:

Front variants:			
Door frame, black		SET210553	7569,50

Energy efficiency index A +

flat

Tunnel

Additional door DHT

Eck

Heating Center

Boiler

Auslaufartikel





Stil-Kamin 51/67 lifting door, single glazing, with top-mount boiler

Set consists of:	Art.-Nr.	No.	Price
Stil-Kamin 51/67 , lifting door, single glazing		1	
Door frame or mounting frame		1	
Chamotte lining set Stil 51/67		1	
ISO upper lining / deflection		1	
Top-mount boiler		1	

Additional options			
EAS (see page 277)			2030,00
Reduced price for EAS without display			-192,50
EOS (see page 277)			3677,50
Smoke pipe adapter for horizontal outlet	BSK7000-129		527,00
Exchange connectiong pieceø 180 mm	I058043		100,00
Double glazing			375,50
Counterweights for non-self closing door	49097		60,50

Available variants:

Front variants:			
Door frame, black		SET210555	8679,00
Mounting frame, black, 50 mm		SET210557	8679,00
Mounting frame, black, 70 mm		SET210559	8762,00

Energy efficiency index A +

flat

Tunnel

Additional door DHT

Eck

Heating Center

Boiler

Architektur-Kamin 38/86, lifting door with top-mount boiler

Auslaufartikel



Set consists of:	Art.-Nr.	No.	Price
AK 38/86 , lifting door, single glazing		1	
Door frame or mounting frame		1	
Inner lining set for Stil AK 38/86		1	
ISO upper lining / deflection		1	
Top-mount boiler AK 38/86		1	

Additional options			
EAS (see page 277)			2030,00
Reduced price for EAS without display			-192,50
EOS (see page 277)			3677,50
Smoke pipe adapter for horizontal/vertical outlet	BSK7000-129		527,00
Exchange connecting piece \varnothing 180 mm	I058043		100,00
Double glazing			416,00

Available variants:

Front variants:			
Door frame, black		SET208761	10507,50
Mounting frame, black, 50 mm		SET208763	10447,00
Mounting frame, black, 70 mm		SET208923	10473,50

Energy efficiency index A +

flat

Tunnel

Additional door DHT

Eck

Heating Center

Boiler





Architektur-Kamin 45/101, lifting door with top-mount boiler

Set consists of:	Art.-Nr.	No.	Price
AK 45/101 , lifting door, single glazing		1	
Door frame or mounting frame		1	
Inner lining set for Stil AK 45/101		1	
ISO upper lining / deflection		1	
Top-mount boiler AK 45/101		1	

Additional options			
EAS (see page 277)			2030,00
Reduced price for EAS without display			-192,50
EOS (see page 277)			3677,50
Smoke pipe adapter for horizontal outlet	I019490		388,50
Double glazing			526,50
Counterweights for non-self closing door	49097		60,50

Available variants:

Front variants:			
Door frame, black		SET205287	10851,00
Mounting frame, black, 50 mm		SET205289	10788,50
Mounting frame, black, 70 mm		SET208925	10835,50

Energy efficiency index A +



Boiler module flat glass

Set consists of:	Art.-Nr.	No.	Price
Boiler module rear outlet		1	2470,00
Additional options			
Conversion kit for top outlet	W027082		184,50

possible combinations:

BKH (from page 12)

flat

Tunnel

Additional door DHT

Eck

Heating Center

Boiler

HKD 2.2 SK Tunnel + EAS (with Moritz's flap mode)

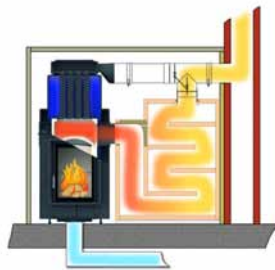

Heat storage mode
with Moritz's flap



Boiler operation
with Moritz's flap

Set consists of:	Art.-Nr.	No.	Price
HKD 2.2 SK DF/DF side-opening door flat glass, Tunnel single glazed for EAS/EOS, with cleaning mechanism		1	
Door frame or mounting frame		2	
Inner lining set for HKD 2.2 SK Tunnel flat/round		1	
Upper lining HKD 2.2 SK		1	
Moritz's smoke valve		1	
EAS (see page 277)		1	
Mounting box		1	
Door switch wiring 2 lm		1	
Thermocouple wiring 2 lm		1	
Bus wiring 2 lm		1	
Connecting piece for side/rear smoke outlet ø 180 mm		1	
Smoke pipe connecting piece ø 180 mm Side		1	

Additional options			
Add. charge EOS ¹			1648,00
Reduced price for EAS without display			-192,50
Smoke pipe outlet on top ø 180 mm	W043140		0,00
Smoke valve actuator with insulation (10338 and 10329) ² (EOS 6 is required)			933,00
Conversion kit/ extension for cleaning on front	11726		259,50
Conversion kit/extension for cleaning on side	W043135		249,00
Double glazing			416,00
Door lock as revision handle	02429		91,00
Door handle black	02056-01		117,00
Option front with door HKD 2.2 round glass			Price on request

Available variants:

Front variants:			
Door frame, black		SET209407	15229,00
Door frame, stainless steel		SET209408	15348,50
Mounting frame, black		SET209409	15491,50
Mounting frame, stainless steel		SET209410	15777,50

¹compared to EAS: EOS control & display unit, second flush-mount box, connecting cable for control & display unit 2m long, 4x water temperature sensor with sleeve and 2x extension cable 3m long.

²possible only in combination with EOS.

Energy efficiency index A +

HKD 2.2 SK Tunnel with direct connection incl. EAS



Boiler operation with direct connection

Set consists of:	Art.-Nr.	No.	Price
HKD 2.2 SK DF/DF side-opening door flat glass, Tunnel single glazed for EAS/EOS, with cleaning mechanism		1	
Door frame or mounting frame		2	
Inner lining set for HKD 2.2 SK Tunnel flat/round		1	
Upper lining HKD 2.2 SK		1	
EAS (see page 277)		1	
Mounting box		1	
Door switch wiring 2 lm		1	
Thermocouple wiring 2 lm		1	
Bus wiring 2 lm		1	
Connecting piece for side/rear smoke outlet ø 180 mm		1	

Additional options			
Add. charge EOS ¹			1648,00
Reduced price for EAS without display			-192,50
Smoke pipe outlet on top ø 180 mm	W043140		0,00
Conversion kit/ extension for cleaning on front	11726		259,50
Conversion kit/extension for cleaning on side	W043135		249,00
Double glazing			416,00
Door lock as revision handle	02429		91,00
Door handle black	02056-01		117,00
Option front with door HKD 2.2 round glass			Price on request

Available variants:

Front variants:			
Door frame, black		SET209421	14635,50
Door frame, stainless steel		SET209422	14755,00
Mounting frame, black		SET209423	14898,00
Mounting frame, stainless steel		SET209424	15184,00

¹compared to EAS: EOS control & display unit, second flush-mount box, connecting cable for control & display unit 2m long, 4x water temperature sensor with sleeve and 2x extension cable 3m long.

Energy efficiency index A +

HKD 2.2 XL SK /h Tunnel + EAS (with Moritz's flap mode)

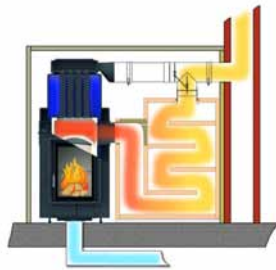

Heat storage mode
with Moritz's flap



Boiler operation
with Moritz's flap

Set consists of:	Art.-Nr.	No.	Price
HKD 2.2 XL SK/h DF/DF side-opening door flat glass, Tunnel, single glazed for EAS/EOS, with cleaning mechanism		1	
Door frame or mounting frame		2	
Inner lining set for HKD 2.2 XL SK/h Tunnel flat/round		1	
Upper lining HKD 2.2 XL SK/h		1	
Moritz's smoke valve		1	
EAS (see page 277)		1	
Mounting box		1	
Door switch wiring 2 lm		1	
Thermocouple wiring 2 lm		1	
Bus wiring 2 lm		1	
Connecting piece for side/rear smoke outlet ø 180 mm		1	
Smoke pipe connecting piece ø 180 mm Side		1	

Additional options			
Add. charge EOS ¹			1648,00
Reduced price for EAS without display			-192,50
Smoke pipe outlet on top ø 180 mm	W043140		0,00
Smoke valve actuator with insulation (10338 and 10329) ² (EOS 6 is required)			933,00
Conversion kit/ extension for cleaning on front	11726		259,50
Conversion kit/extension for cleaning on side	W043135		249,00
Double glazing			416,00
Door lock as revision handle	02429		91,00
Door handle black	02056-01		117,00
Option front with door HKD 2.2 round glass			Price on request

Available variants:

Front variants:			
Door frame, black		SET209438	15693,50
Door frame, stainless steel		SET209439	15813,00
Mounting frame, black		SET209440	15956,00
Mounting frame, stainless steel		SET209441	16242,00

¹ compared to EAS: EOS control & display unit, second flush-mount box, connecting cable for control & display unit 2m long, 4x water temperature sensor with sleeve and 2x extension cable 3m long.

² possible only in combination with EOS.

Energy efficiency index A +

HKD 2.2 XL SK /h Tunnel with direct connection incl. EAS

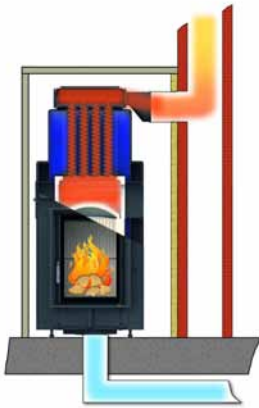

Boiler operation with direct connection

Set consists of:	Art.-Nr.	No.	Price
HKD 2.2 XL SK/h DF/DF side-opening door flat glass, Tunnel , single glazed for EAS/EOS, with cleaning mechanism		1	
Door frame or mounting frame		2	
Inner lining set for HKD 2.2 XL SK/h Tunnel flat/round		1	
Upper lining HKD 2.2 XL SK/h		1	
EAS (see page 277)		1	
Mounting box		1	
Door switch wiring 2 lm		1	
Thermocouple wiring 2 lm		1	
Bus wiring 2 lm		1	
Connecting piece for side/rear smoke outlet ø 180 mm		1	

Additional options			
Add. charge EOS ¹			1648,00
Reduced price for EAS without display			-192,50
Smoke pipe outlet on top ø 180 mm	W043140		0,00
Conversion kit/ extension for cleaning on front	11726		259,50
Conversion kit/extension for cleaning on side	W043135		249,00
Double glazing			416,00
Door lock as revision handle	02429		91,00
Door handle black	02056-01		117,00
Option front with door HKD 2.2 round glass			Price on request

Available variants:

Front variants:			
Door frame, black		SET209443	15100,00
Door frame, stainless steel		SET209444	15220,00
Mounting frame, black		SET209445	15363,00
Mounting frame, stainless steel		SET209446	15649,00

¹compared to EAS: EOS control & display unit, second flush-mount box, connecting cable for control & display unit 2m long, 4x water temperature sensor with sleeve and 2x extension cable 3m long.

Energy efficiency index A +

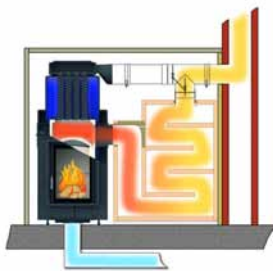

Heat storage mode
with Moritz's flap

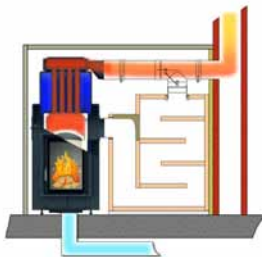

Boiler operation
with Moritz's flap

HKD 7 SK Tunnel + EAS (with Moritz's flap mode)

Set consists of:	Art.-Nr.	No.	Price
HKD 7 SK DF/DF side-opening door flat glass, Tunnel single glazed for EAS/EOS, with cleaning mechanism		1	
Door frame or mounting frame		2	
Inner lining set for HKD 7 SK Tunnel		1	
Upper lining HKD 7 SK		1	
Moritz's smoke valve		1	
EAS (see page 277)		1	
Mounting box		1	
Door switch wiring 2 lm		1	
Thermocouple wiring 2 lm		1	
Bus wiring 2 lm		1	
Connecting piece for side/rear smoke outlet ø 180 mm		1	
Smoke pipe connecting piece ø 180 mm Side		1	

Additional options

Add. charge EOS ¹			1648,00
Reduced price for EAS without display			-192,50
Smoke pipe outlet on top ø 180 mm	W043140		0,00
Smoke valve actuator with insulation (10338 and 10329) ² (EOS 6 is required)			933,00
Conversion kit/ extension for cleaning on front	11726		259,50
Conversion kit/extension for cleaning on side	W043135		249,00
Conversion kit for cleaning on top including push-in handle	BSO5000-123		275,50
Double glazing			416,00
Door handle black	02056-01		117,00

Available variants:

Front variants:			
Door frame, black		SET213006	17305,50
Mounting frame, black		SET213007	17269,00

¹ compared to EAS: EOS control & display unit, second flush-mount box, connecting cable for control & display unit 2m long, 4x water temperature sensor with sleeve and 2x extension cable 3m long.

² possible only in combination with EOS.

Energy efficiency index A +

HKD 7 SK Tunnel with direct connection incl. EAS



Boiler operation with direct connection

Set consists of:	Art.-Nr.	No.	Price
HKD 7 SK DF/DF side-opening door flat glass, Tunnel single glazed for EAS/EOS, with cleaning mechanism		1	
Door frame or mounting frame		2	
Inner lining set for HKD 7 SK Tunnel		1	
Upper lining HKD 7 SK		1	
EAS (see page 277)		1	
Mounting box		1	
Door switch wiring 2 lm		1	
Thermocouple wiring 2 lm		1	
Bus wiring 2 lm		1	
Connecting piece for side/rear smoke outlet ø 180 mm		1	

Additional options			
Add. charge EOS ¹			1648,00
Reduced price for EAS without display			-192,50
Smoke pipe outlet on top ø 180 mm	W043140		0,00
Conversion kit/ extension for cleaning on front	11726		259,50
Conversion kit/extension for cleaning on side	W043135		249,00
Conversion kit for cleaning on top including push-in handle	BSO5000-123		275,50
Double glazing			416,00
Door handle black	02056-01		117,00

Available variants:

Front variants:			
Door frame, black		SET213008	16712,00
Mounting frame, black		SET213009	16676,00

¹compared to EAS: EOS control & display unit, second flush-mount box, connecting cable for control & display unit 2m long, 4x water temperature sensor with sleeve and 2x extension cable 3m long.

Energy efficiency index A +

Auslaufartikel

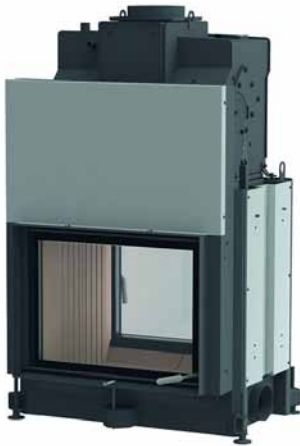

Stil-Kamin Tunnel 51/67 ST/DT, single glazing, with top-mount boiler

Set consists of:	Art.-Nr.	No.	Price
Stil-Kamin Tunnel , 51/67 ST/DT, single glazing		1	
Door frame or mounting frame		2	
Chamotte lining set Stil Tunnel 51/67		1	
ISO upper lining / deflection		1	
Top-mount boiler		1	

Additional options			
EAS (see page 277)			2218,50
Reduced price for EAS without display			-192,50
EOS (see page 277)			3866,00
Smoke pipe adapter for horizontal/vertical outlet	BSK7000-129		527,00
Counterweights for non-self closing door	49097		60,50
Double glazing			751,50
Revision handle	02426		169,00
Version with 2 lifting doors upon request			

Available variants:

Front variants:			
Door frame, black		SET210564	11964,50
Door frame, black DT Mounting frame, black ST 50 mm		SET210566	11964,50
Door frame, black DT Mounting frame, black ST 70 mm		SET210568	12048,00

Energy efficiency index A +

flat

Tunnel

Additional door DHT

Eck

Heating Center

Boiler

Architektur-Kamin Tunnel 38/86, lifting/tilting door, with top-mount boiler



Auslaufartikel



Set consists of:	Art.-Nr.	No.	Price
AK Tunnel 38/86, ST/KT, single glazing		1	
Door frame or mounting frame		2	
Inner lining set for Stil AK Tunnel 38/86		1	
ISO upper lining / deflection		1	
Top-mount boiler AK 38/86		1	

Additional options			
EAS (see page 277)			2030,00
Reduced price for EAS without display			-192,50
EOS (see page 277)			3677,50
Smoke pipe adapter for horizontal/vertical outlet	BSK7000-129		527,00
Exchange connecting piece ø 180 mm	I058043		100,00
Double glazing (also one side only available on request)			832,00
Counterweights for non-self closing door	49097		60,50
Version with 2 lifting doors upon request			

Available variants:

Front variants:			
Door frame, black		SET208767	13353,50
Mounting frame, black, 50 mm		SET208769	13232,50
Mounting frame, black, 70 mm		SET208924	13286,00

Energy efficiency index A +

Flat

Tunnel

Additional door DHT

Eck

Heating Center

Boiler





Architektur-Kamin Tunnel 45/101, ST/KT, with top-mount boiler

Set consists of:	Art.-Nr.	No.	Price
Fireplace waterbearing Tunnel AK 45/101, single glazing		1	
Door frame or mounting frame		2	
Inner lining set for Fireplace waterbearing Tunnel 45/101		1	
ISO upper lining / deflection		1	
Top-mount boiler AK 45/101		1	

Additional options			
EAS (see page 277)			2030,00
Reduced price for EAS without display			-192,50
EOS (see page 277)			3677,50
Smoke pipe adapter for horizontal outlet	I019490		388,50
Double glazing			1053,00
Counterweights for non-self closing door	49097		60,50
Version with 2 lifting doors upon request			

Available variants:

Front variants:			
Door frame, black		SET208281	13957,00
Mounting frame, black, 50 mm		SET208283	13832,00
Mounting frame, black, 70 mm		SET208926	13925,50

Energy efficiency index A +



Boiler module Tunnel

Set consists of:	Art.-Nr.	No.	Price
Boiler module rear outlet		1	2470,00
Additional options			
Conversion kit for top outlet	W027082		184,50

possible combinations:

BKH (from page 34)

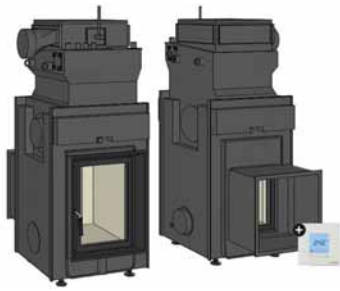

Heat storage mode with Moritz's flap



Boiler operation with Moritz's flap

HKD 2.2 SK + EAS DHT M (with Moritz's flap mode)

Set consists of:	Art.-Nr.	No.	Price
HKD 2.2 SK DF side-opening door flat glass, single glazed for EAS/EOS, with cleaning mechanism DHT M		1	
Door frame or mounting frame		1	
Inner lining set for HKD 2.2 SK flat/round		1	
Upper lining HKD 2.2 SK		1	
Moritz's smoke valve		1	
EAS (see page 277)		1	
Mounting box		1	
Door switch wiring 2 lm		1	
Thermocouple wiring 2 lm		1	
Bus wiring 2 lm		1	
Connecting piece for side/rear smoke outlet ø 180 mm		1	
Smoke pipe connecting piece ø 180 mm Side		1	

Additional options

Add. charge EOS ¹			1648,00
Reduced price for EAS without display			-192,50
Smoke pipe outlet on top ø 180 mm	W043140		0,00
Smoke valve actuator with insulation (10338 and 10329) ²			933,00
Double glazing			208,00
Revision handle	02429		91,00
Door handle black	02056-01		117,00
Option front with door HKD 2.2 round glass			Price on request

Available variants:

Front variants:			
Door frame, black		SET212281	14867,00
Door frame, stainless steel		SET212282	14926,50
Mounting frame, black		SET212283	14998,00
Mounting frame, stainless steel		SET212284	15141,00

¹compared to EAS: EOS control & display unit, second flush-mount box, connecting cable for control & display unit 2m long, 4x water temperature sensor with sleeve and 2x extension cable 3m long.

²possible only in combination with EOS.

Energy efficiency index A +

flat

Tunnel

Additional door DHT

Boiler

Eck

Heating Center

HKD 2.2 SK + EAS DHT M with direct connection

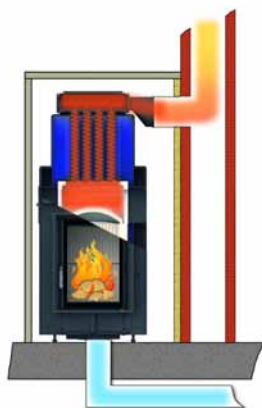
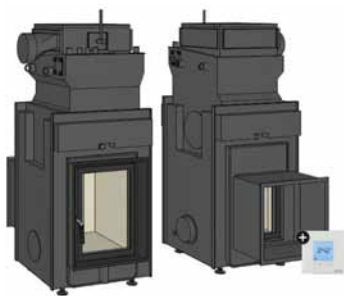

Boiler operation with direct connection

Set consists of:	Art.-Nr.	No.	Price
HKD 2.2 SK DF side-opening door flat glass, single glazed for EAS/EOS DHT M		1	
Door frame or mounting frame		1	
Inner lining set for HKD 2.2 SK flat/round		1	
Upper lining HKD 2.2 SK		1	
EAS (see page 277)		1	
Mounting box		1	
Door switch wiring 2 lm		1	
Thermocouple wiring 2 lm		1	
Bus wiring 2 lm		1	
Connecting piece for side/rear smoke outlet \varnothing 180 mm		1	

Additional options			
Add. charge EOS ¹			1648,00
Reduced price for EAS without display			-192,50
Smoke pipe outlet on top \varnothing 180 mm	W043140		0,00
Double glazing			208,00
Revision handle	02429		91,00
Door handle black	02056-01		117,00
Option front with door HKD 2.2 round glass			Price on request

Available variants:

Front variants:			
Door frame, black		SET212286	14273,50
Door frame, stainless steel		SET212287	14333,00
Mounting frame, black		SET212288	14404,50
Mounting frame, stainless steel		SET212289	14547,50

¹compared to EAS: EOS control & display unit, second flush-mount box, connecting cable for control & display unit 2m long, 4x water temperature sensor with sleeve and 2x extension cable 3m long.

Energy efficiency index A +

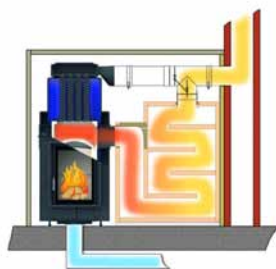
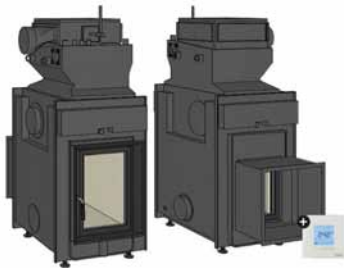

Heat storage mode
with Moritz's flap

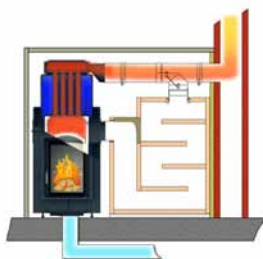

Boiler operation
with Moritz's flap

HKD 2.2 XL SK/h + EAS DHT M (with Moritz's flap mode)

Set consists of:	Art.-Nr.	No.	Price
HKD 2.2 XL SK/h DF side-opening door flat glass , single glazed for EAS/EOS with cleaning mechanism DHT M		1	
Door frame or mounting frame		1	
Inner lining set for HKD 2.2 XL SK /h flat/round		1	
Upper lining HKD 2.2 XL SK /h		1	
Moritz's smoke valve		1	
EAS (see page 277)		1	
Mounting box		1	
Door switch wiring 2 lm		1	
Thermocouple wiring 2 lm		1	
Bus wiring 2 lm		1	
Connecting piece for side/rear smoke outlet ø 180 mm		1	
Smoke pipe connecting piece ø 180 mm Side		1	

Additional options

Add. charge EOS ¹			1648,00
Reduced price for EAS without display			-192,50
Rauchrohrabgang oben ø 180 mm	W043140		0,00
Smoke valve actuator with insulation (10338 and 10329)			933,00
Double glazing			208,00
Revision handle	02429		91,00
Door handle black	02056-01		117,00
Option front with door HKD 2.2 round glass			Price on request

Available variants:

Front variants:			
Door frame, black		SET212291	15336,00
Door frame, stainless steel		SET212292	15396,00
Mounting frame, black		SET212293	15467,50
Mounting frame, stainless steel		SET212294	15610,50

¹compared to EAS: EOS control & display unit, second flush-mount box, connecting cable for control & display unit 2m long, 4x water temperature sensor with sleeve and 2x extension cable 3m long.

²possible only in combination with EOS.

Energy efficiency index A +

HKD 2.2 XL SK/h + EAS DHT M with direct connection

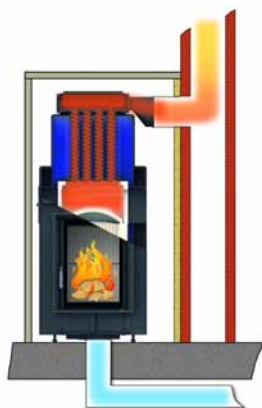
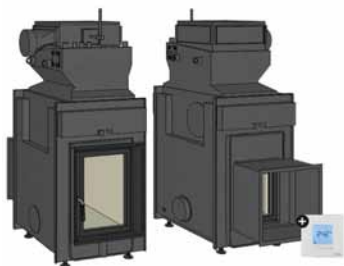

Boiler operation with direct connection

Set consists of:	Art.-Nr.	No.	Price
HKD 2.2 XL SK/h DF side-opening door flat glass , single glazed for EAS/EOS with cleaning mechanism DHT M		1	
Door frame or mounting frame		1	
Inner lining set for HKD 2.2 XL SK /h flat/round		1	
Upper lining HKD 2.2 XL SK /h		1	
EAS (see page 277)		1	
Mounting box		1	
Door switch wiring 2 lm		1	
Thermocouple wiring 2 lm		1	
Bus wiring 2 lm		1	
Connecting piece for side/rear smoke outlet \varnothing 180 mm		1	

Additional options			
Add. charge EOS ¹			1648,00
Reduced price for EAS without display			-192,50
Smoke pipe outlet on top \varnothing 180 mm	W043140		0,00
Double glazing			208,00
Revision handle	02429		91,00
Door handle black	02056-01		117,00
Option front with door HKD 2.2 round glass			Price on request

Available variants:

Front variants:			
Door frame, black		SET212296	14742,50
Door frame, stainless steel		SET212297	14802,50
Mounting frame, black		SET212298	14874,00
Mounting frame, stainless steel		SET212299	15017,00

¹compared to EAS: EOS control & display unit, second flush-mount box, connecting cable for control & display unit 2m long, 4x water temperature sensor with sleeve and 2x extension cable 3m long.

Energy efficiency index A +



Corner fireplace waterbearing 42/57/30 left side, side-opening door

Set consists of:	Art.-Nr.	No.	Price
Corner fireplace waterbearing 42/57/30 left side, side-opening door two-piece ceramic glass, outlet \varnothing 180 mm		1	
Door frame or mounting frame		1	
Inner lining set, bright, for Kamin-Kessel Eck 42/57/30 l/r		1	

Additional options			
EAS (see page 277)			2030,00
Reduced price for EAS without display			-192,50
EOS (see page 277)			3677,50

Available variants:

Front variants:			
Mounting frame, black 50 mm		SET213018	7704,00
Door frame		SET213067	7620,00

Energy efficiency index A +



Corner fireplace waterbearing 42/57/30 right side, side-opening door

Set consists of:	Art.-Nr.	No.	Price
Corner fireplace waterbearing 42/57/30 right side, side-opening door two-piece ceramic glass, outlet \varnothing 180 mm		1	
Door frame or mounting frame		1	
Inner lining set, bright, for Kamin-Kessel Eck 42/57/30 l/r		1	

Additional options			
EAS (see page 277)			2030,00
Reduced price for EAS without display			-192,50
EOS (see page 277)			3677,50

Available variants:

Front variants:			
Mounting frame, black 50 mm		SET213019	7704,00
Door frame		SET213068	7620,00

Energy efficiency index A +

Corner fireplace waterbearing 45/67/44 left side, lifting door



Set consists of:	Art.-Nr.	No.	Price
Corner fireplace waterbearing 45/67/44 left side, lifting door two-piece ceramic glass, outlet ø 180 mm		1	
Mounting frame		1	
Inner lining set, bright, for Kamin-Kessel Eck 45/67/44 l/r		1	
ISO upper lining		1	

Additional options			
EAS (see page 277)			2030,00
Reduced price for EAS without display			-192,50
EOS (see page 277)			3677,50
Counterweights for non-self closing door	49097		60,50
Conversion kit/ extension for cleaning on front	11726		259,50
Conversion kit/extension for cleaning on side	W043135		249,00
Conversion kit for cleaning on top including push-in handle	BSK2000-201		272,50

Available variants:

Front variants:			
Mounting frame, black, 50 mm		SET212984	10307,00
Mounting frame, black, 70 mm		SET212986	10483,00

Energy efficiency index A +

Corner fireplace waterbearing 45/67/44 right side, lifting door



Set consists of:	Art.-Nr.	No.	Price
Corner fireplace waterbearing 45/67/44 right side, lifting door two-piece ceramic glass, outlet ø 180 mm		1	
Mounting frame		1	
Inner lining set, bright, for Kamin-Kessel Eck 45/67/44 l/r		1	
ISO upper lining		1	

Additional options			
EAS (see page 277)			2030,00
Reduced price for EAS without display			-192,50
EOS (see page 277)			3677,50
Counterweights for non-self closing door	49097		60,50
Conversion kit/ extension for cleaning on front	11726		259,50
Conversion kit/extension for cleaning on side	W043135		249,00
Conversion kit for cleaning on top including push-in handle	BSK2000-201		272,50

Available variants:

Front variants:			
Mounting frame, black, 50 mm		SET212989	10307,00
Mounting frame, black, 70 mm		SET212991	10483,00

Energy efficiency index A +



Boiler module Eck

Set consists of:	Art.-Nr.	No.	Price
Boiler module rear outlet		1	2470,00
Additional options			
Conversion kit for top outlet	W027082		184,50

possible combinations:

BKH (from page 54)

	Art.-Nr.	Infos	Designation	Price
Accessories Boiler technology				
	00717.1	<input type="checkbox"/>	Tiled stove pump unit	994,00
	00719.1	<input type="checkbox"/>	Pump control incl. 2 pieces PT 1000	210,50
	902350	<input type="checkbox"/>	Safety valve 651 HN 1/2"	47,00

flat

Tunnel

Additional door DHT



Eck





Heating Center

BHZ - BRUNNER Heating Center





Heating Center 3.0



	Art.-Nr.	info	Designation	Price
Heating Center BHZ 15-50 kW				
For approved hydraulic diagrams, refer to Brunner Hydraulic Manual (https://www.brunner.de/produktdownloads/kessel-waermepumpen/00_brunner_hydraulik-handbuch_5_2022.pdf)				
		■	Heating Center basic module - Hydraulic box, ready for connection, for combination with the BRUNNER system storage tank. Basic module with: - System controller with 5,7"-VGA-Touch-Display - Set of hoses for connection with storage tank, with thermal insulation	
	V009001-02		Basic module BHZ 3.0 with touch-display	6500,00
		■	Heating Center basic module - Hydraulic box, ready for connection, for combination with the BRUNNER system storage tank. Basic module with: - System controller without 5,7"-VGA-Touch-Display - Set of hoses for connection with storage tank, with thermal insulation - Blind cover for Heating Center	
	V009001-01		BHZ 3.0 basic module without touch-display	4795,00
■ must be ordered ■ make a choice □ optional				



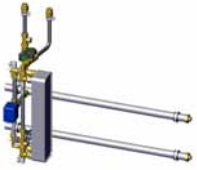
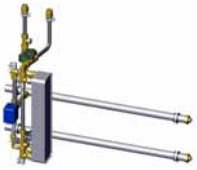

	Art.-Nr.	info	Designation	Price
Heat generator				
Solid fuel module				
	V009104	■	Tiled stove circuit - motorized return flow increase - incl. integrated power measurement	1322,00
Return flow for solid fuel boiler / Collector pipe Heat generator				
	V009098	■	Return flow for solid fuel boiler as well as collector for heat generators * without power measurement *for example: oil/gas boiler etc.	319,00
	V009008-02	■	Return flow for solid fuel boiler as well as collector for heat generators * with power measurement - System storage connection to hydraulic box on the left - connection oil/gas boiler etc. right side to the hydraulic box *for example: oil/gas boiler etc.	658,00
	V009008-01	■	Return flow for solid fuel boiler as well as collector for heat generators * with power measurement - System storage connection to hydraulic box on the right - connection oil/gas boiler etc. left side to the hydraulic box *for example: oil/gas boiler etc.	658,00
■ must be ordered ■ make a choice □ optional				

	Art.-Nr.	info	Designation	Price
Heat generator				
Solar module				
	V009005	<input type="checkbox"/>	Solar module with system separation - Collector sensor by customer - incl. integrated power measurement - Solar primary pump: Wilo Yonos Para ST 15/13 PWM 2, 130 - Solar secondary pump Wilo Yonos Para 15/6 PWM 1, 130	2973,00
Photovoltaic connection				
	V009340-01	<input type="checkbox"/>	Photovoltaic connection for BHZ 3.0 for hot water preparation and heating support incl. - 2 directional energy meter - Electrical screw-in heater 9 kW with safety temperature limiter - Tube set for BHZ 3.0 - Electronic Power Controller Upgradeable for all systems with BHZ 3.0 + System Storage 3.0.	3109,50
ATTENTION: The PV module requires the use of the fresh water module (not possible with hot water storage- module)				
Elektro-Zentralheizungsmodul				
	V009340-03	<input type="checkbox"/>	Electric central heating module BHZ 3.0 for hot water and heating incl. - Electric screw-in heater 9 kW with STB (safety temperature limiter) - Tube set for BHZ 3.0 - Electronic power controller Upgradeable for all systems with BHZ 3.0 + System Storage 3.0.	1729,00
CAUTION: Precondition for the electro- central heating module is the use of the fresh water module (not with hot water storage module possible)				
<input checked="" type="checkbox"/> must be ordered <input checked="" type="checkbox"/> make a choice <input type="checkbox"/> optional				
Heat pump-integration				
	V009390	<input type="checkbox"/>	Integration of air-water heat pump Brunner BWP 3/13 only for Brunner heat pump BWP	1771,50
	V009380-01	<input type="checkbox"/>	Einbindung Fremdwärmepumpe bis 20 kW	1453,50
Note				
- when using heat pump connection, it is not possible to integrate solar module V009005 - when using heat pumps integration, only the system memory 750 liters Art-No. V009800 or 1000 liters Art. No. V009850 can be used - Heat pump integration V009390 can only be retrofitted to BHZ 3.0 if the above mentioned points are given				
<input checked="" type="checkbox"/> must be ordered <input checked="" type="checkbox"/> make a choice <input type="checkbox"/> optional				



	Art.-Nr.	info	Designation	Price
Heat generator				

Electric heaters				
	900822	<input type="checkbox"/>	<p>Electric immersion heater 9 kW with safety temperature limit</p> <p>Immersion depth: 810 mm Non-heated length: 100 mm Thread size: G 1 1/2 " Degree of protection: IP 64 Mounting position: horizontal or vertical from top Star connection, suitable for continuous operation</p> <p>Suitable for installation in Brunner System Storage 3.0 and all commercially available buffer tanks</p>	515,50
	901106	<input type="checkbox"/>	<p>Electric screw in heater 6 kW with safety temperature limiter</p> <p>Immersion depth: 480 mm Length unheated: 100 mm Screw head: G 1 1/2 " Protection class: IP 64 Installation: horizontal and vertical from above Star circuit, suitable for continuous operation</p> <p>Suitable for installation in all Brunner system storages and all standard buffers</p>	512,00
<input checked="" type="checkbox"/> must be ordered <input checked="" type="checkbox"/> make a choice <input type="checkbox"/> optional				

	Art.-Nr.	info	Designation	Price
Heat consumer				
Fresh water module				
	V009490	<input checked="" type="checkbox"/>	<p>Fresh water module 40 l/min: Stainless steel plate heat exchanger with copper soldering</p> <p>Fresh water module 40 L per minute, for fast and hygienic potable water heating in the flow process. Suitable for use in multiple family homes.</p> <ul style="list-style-type: none"> - incl. integrated power measurement - Typ Wilo Para 15/8/130 PWM - incl. V009310 Insulation fresh water module BHZ - Esbe Vormischventil Typ: VTA 370 	3648,00
	V009530	<input checked="" type="checkbox"/>	<p>Fresh water module 40 l/min: Stainless steel plate heat exchanger with nickel soldering</p> <p>Fresh water module 40 L per minute, for fast and hygienic potable water heating in the flow process. Suitable for use in multiple family homes.</p> <ul style="list-style-type: none"> - incl. integrated power measurement - Typ Wilo Para 15/8/130 PWM - incl. V009310 Insulation fresh water module BHZ - Esbe Vormischventil Typ: VTA 370 	7236,50
	V009135	<input type="checkbox"/>	<p>Circulation connection incl. pump in combination with fresh water station</p> <p>Circulation pump Wilo ZRS 15/4. (possible only in combination with fresh water module)</p>	325,00
Hot water loading module				
	V005045	<input checked="" type="checkbox"/>	<p>Hot water loading module</p> <p>Hot water loading module for external hot water storage tank. For use in single-family houses or twin housings.</p>	888,50
<input checked="" type="checkbox"/> must be ordered <input checked="" type="checkbox"/> make a choice <input type="checkbox"/> optional				



	Art.-Nr.	info	Designation	Price
Heat consumer				
Heating circuit module 1				
	V009102	<input checked="" type="checkbox"/>	Mixed heating circuit group 1 with power measurement Heating circuit module with pump Wilo Yonos Para 13/130, e.g. NT-type panel heaters, radiators, convectors or heating pipe systems (underfloor heating or wall-mount heating registers) with power measurement.	1322,00
	V005044	<input checked="" type="checkbox"/>	Mixed heating circuit group 1 without power measurement Heating circuit module with pump Wilo Yonos Para RS 15/6 for outdoor temperature controlled operation with one heating circuit, e.g. NT-type panel heaters, radiators, convectors or heating pipe systems (underfloor heating or wall-mount heating registers) without power measurement.	1120,50
Heat consumer				
Heating circuit module 2				
	V009102	<input checked="" type="checkbox"/>	Mixed heating circuit group 2 with power measurement Heating circuit module with pump Wilo Yonos Para 13/130, e.g. NT-type panel heaters, radiators, convectors or heating pipe systems (underfloor heating or wall-mount heating registers) with power measurement.	1322,00
	V005044	<input checked="" type="checkbox"/>	Mixed heating circuit group 2 without power measurement Heating circuit module with pump Wilo Yonos Para RS 15/6 for outdoor temperature controlled operation with one heating circuit, e.g. NT-type panel heaters, radiators, convectors or heating pipe systems (underfloor heating or wall-mount heating registers) without power measurement.	1120,50
<input checked="" type="checkbox"/> must be ordered <input checked="" type="checkbox"/> make a choice <input type="checkbox"/> optional				

	Art.-Nr.	info	Designation	Price
Accessories for Heating Center				
	E006004-20	<input type="checkbox"/>	Extension board 'Heating circuits' In wall-mount box. For outdoor temperature controlled operation with 2 additional heating circuits - 2 pcs. surface sensors Pt 1000 for heating circuit flow line, with mounting clamp -incl. connection possibility for 2 heat metering systems in combination with UK 100090-01 Connecting cable for data E013005-.. 3-wire required	999,00
	UK100090	<input type="checkbox"/>	Mixed heating circuit group 3,4,5,6, DN 25 without power measurement Heating circuit module with pump Wilo Yonos Para 25/6, for e.g. NT-type panel heaters, radiators, convectors or heating pipe systems (underfloor heating or wall-mount heating registers)	1005,50
	UK100090-01	<input type="checkbox"/>	Mixed heating circuit group 3,4,5,6 DN 25 with power measurement Heating circuit group with volume flow metering, with pump Wilo Yonos Para 25/6, for e.g. NT-type panel heaters, radiators, convectors or heating pipe systems (underfloor heating or wall-mount heating registers)	1410,00
	900197	<input type="checkbox"/>	Manifold 2x, DN 25 - Manifold with wall mounting bracket, for 2 heating circuit modules, or alternatively for 1 heating circuit module and 1 hot water tank loading module - Flow and Return are thermally separated, with EPP thermal insulation	457,00
	900198	<input type="checkbox"/>	Manifold 3x, DN 25 - Manifold with wall mounting bracket, for 3 heating circuit modules, or alternatively for 2 pcs. heating circuit module and 1 pc. hot water tank loading module - Flow and Return are thermally separated, with EPP thermal insulation	549,50
	900199	<input type="checkbox"/>	Manifold 5x, DN 25 - Manifold with wall mounting bracket, for 5 heating circuit modules, or alternatively for 4 pcs. heating circuit module and 1 pc. hot water tank loading module - Flow and Return are thermally separated, with EPP thermal insulation	1398,00
	900288	<input type="checkbox"/>	Power inverter + battery box NV500/1000 For uninterrupted operation (emergency power supply) during power outages. Suitable for typical 12 Volt lead batteries for automotive or solar applications with a capacity between 65 Ah and 125 Ah (the battery is not supplied).	984,00
	SET211001	<input checked="" type="checkbox"/>	Insulating shell kit consists of 2 collector pipe insulating pieces	53,50
<input checked="" type="checkbox"/> must be ordered <input checked="" type="checkbox"/> make a choice <input type="checkbox"/> optional				



	Art.-Nr.	info	Designation	Price
Accessories for Heating Center				
		<input type="checkbox"/>	Mounting box Flush-mount box for installation of additional touchsensitive display.	
	900001		Standard mounting box Dimensions L x W x D = 159 x 159 x 75 mm	17,00
	E004007-01		Mounting box for dry wall installation Dimensions L x W x D = 165 x 165 x 72 mm	108,50
		<input type="checkbox"/>	Connection wiring Touch-Display universal connection wiring (CAN-Bus) for data exchange between wood and pellet boilers, BHZ Heating Center and all extension boards with additional Touch-Display (5 wires)	
	E013001-2		Connection wiring 2 m	30,50
	E013001-3		Connection wiring 3 m	33,00
	E013001-4		Connection wiring 4 m	37,00
	E013001-5		Connection wiring 5 m	40,50
	E013001-7		Connection wiring 7 m	49,00
	E013001-10		Connection wiring 10 m	58,50
			Connection wiring > 10 m up to max. 30 m by metre	upon request
		<input type="checkbox"/>	Connection wiring Data universal connection wiring (CAN-Bus) for data exchange between wood and pellet boilers, BHZ Heating Center and all extension boards (3 wires)	
	E013005-1		Connection wiring 0,7 m	23,50
	E013005-2		Connection wiring 2 m	27,50
	E013005-3		Connection wiring 3 m	30,50
	E013005-4		Connection wiring 4 m	33,00
	E013005-5		Connection wiring 5 m	37,50
	E013005-7		Connection wiring 7 m	43,50
	E013005-10		Connection wiring 10 m	56,00
			Connection wiring > 10 m up to max. 30 m by metre	upon request
■ must be ordered ■ make a choice □ optional				

	Art.-Nr.	info	Designation	Price
Accessories for Heating Center				
		<input type="checkbox"/>	Extension wiring for temperature sensor extension wiring with screen, for Pt 1000 temperature sensors	
	E013013-01		Extension wiring 3 m	45,50
	E013013-02		Extension wiring 5 m	52,00
	E013013-03		Extension wiring 10 m	75,50
	E013013-04		Extension wiring 15 m	93,50
	10339	<input type="checkbox"/>	Temperature sensor with immersion sleeve for variable use, e.g. as boiler sensor for existing solid fuel boilers Temperature sensor Pt1000 with immersion sleeve DN 15 (1/2")	49,00
	900205	<input type="checkbox"/>	Temperature sensor with clamping band for variable use, e.g. as boiler sensor for existing solid fuel boilers Temperature sensor Pt1000 with clamping band as contact sensor	19,00
	V009181	<input type="checkbox"/>	Passage from 22 ferrule/1" male	18,00
■ must be ordered ■ make a choice □ optional				

	Art.-Nr.	Infos	Designation	Price
System storage				
		<input type="checkbox"/>	System storage The system storage (buffer tank) is enabled for laminar loading and optimized for operation with renewable heating sources. - Efficient thermal insulation from 100 mm Polyester mats (thermal conductivity index WLG = 0,35) - Incl. 8 pcs. ball valves - Connection option for Brunner air-water heat pump BWP 3/13	
	V009800		System storage 750 l	2828,00
	V009850		System storage 1000 l	3100,50



Accessories System storage				
	900098		Automatic top-of-tank breather (for all system storage tanks)	18,00
	V005363		Horizontal venting pipe for system storage 750l und 1000l	32,50
	V006068		Horizontal venting pipe for system storage 1500l	34,00
	V008074		Horizontal venting pipe for system storage 2000 l	36,00



System storage				
		<input type="checkbox"/>	System storage The system storage (buffer tank) is enabled for laminar loading and optimized for operation with renewable heating sources. - Efficient thermal insulation from 100 mm Polyester mats (thermal conductivity index WLG = 0,35) - Incl. 8 pcs. ball valves	
	V006070		System storage 1500 l	3847,50
	V008080		System storage 2000 l	4691,00

Accessories System storage				
	900098		Automatic top-of-tank breather (for all system storage tanks)	18,00
	V005363		Horizontal venting pipe for system storage 750l und 1000l	32,50
	V006068		Horizontal venting pipe for system storage 1500l	34,00
	V008074		Horizontal venting pipe for system storage 2000 l	36,00

	Art.-Nr.	Infos	Designation	Price
Standard storage				
		<input type="checkbox"/>	Standard storage The standard storage (buffer tank) for extension of storage volume.	
	V007023		Standard storage 750 l	1611,50
	V005071		Standard storage 1000 l	2064,00
	V006048		Standard storage 1500 l	2745,00
	V008050		Standard storage 2000 l	3260,00

System storage tank and Standard storage tank can be hydraulically connected by using a set of connecting hoses (see Accessories for storage tanks). Both tanks must be of the same size and volume.

Accessories for storage tanks				
		<input type="checkbox"/>	Flexible hose connection kit insulated for hydraulic connection between System storage tank and Standard storage tank. Both tanks must be of the same size and volume.	
	900122K		Flexible hose connection kit insulated consisting of: - 8 pcs. double threaded fitting with gasket - 4 pcs. flexible hose, L=170 mm	327,00
	900123K		Flexible hose connection kit insulated consisting of: - 8 pcs. double threaded fitting with gasket - 4 pcs. flexible hose, L=450 mm	367,50
	SET211000	<input checked="" type="checkbox"/>	Ball valves insulation KIT consisting of 4 pcs. insulation for ball valve DN 32 with ball valve extension 4 pcs. insulation for ball valve DN 25 with ball valve extension	252,00
<input checked="" type="checkbox"/> must be ordered <input checked="" type="checkbox"/> make a choice <input type="checkbox"/> optional				

	Art.-Nr.	Infos	Designation	Price
Free installation of the extension board basic				
For approved hydraulic diagrams, refer to Brunner Hydraulic Manual				
(https://www.brunner.de/produktdownloads/kessel-waermepumpen/00_brunner_hydraulik-handbuch_5_2022.pdf)				
	E006004-10	<input checked="" type="checkbox"/>	Extension board 'Basic' In wall-mount box. For outdoor temperature controlled operation of 2 mixed heating circuits, hot water storage tank loading, incl. necessary temperature sensors (Data wiring with 3 wires is necessary for connection with boiler). - 3 pcs. storage tank sensor Pt 1000 with sleeve DN 15 (1/2") - 2 pcs. surface sensors Pt 1000 for heating circuit flow line, with mounting clamp - 1 pc. hot water storage tank temperature sensor Pt 1000 with sleeve DN 15 (1/2") - 1 pc. outdoor sensor Pt 1000 Precondition for this version: Boiler operation with EOS 6	1211,50
Hydraulic components				
	UK100090	<input type="checkbox"/>	Mixed heating circuit 1-6, DN 25 Heating circuit module with pump Wilo Yonos Para 25/6, for e.g. NT-type panel heaters, radiators, convectors or heating pipe systems (underfloor heating or wall-mount heating registers)	1005,50
	UK100100	<input type="checkbox"/>	Hot water storage external loading module, DN Hot water storage loading module with pump Wilo Yonos Para 25/6, for loading of a new or already existing hot water storage tank in case of high demand for domestic hot water	685,00
<input checked="" type="checkbox"/> must be ordered <input checked="" type="checkbox"/> make a choice <input type="checkbox"/> optional				

	Art.-Nr.	Infos	Designation	Price
Accessories for free installation				
	900197	<input type="checkbox"/>	Manifold 2x, DN 25 - Manifold with wall mounting bracket, for 2 heating circuit modules, or alternatively for 1 pc. heating circuit module and 1 pc. hot water tank loading module - Flow and Return are thermally separated, with EPP thermal insulation	457,00
	900198	<input type="checkbox"/>	Manifold 3x, DN 25 - Manifold with wall mounting bracket, for 3 heating circuit modules, or alternatively for 2 pcs. heating circuit module and 1 pc. hot water tank loading module - Flow and Return are thermally separated, with EPP thermal insulation	549,50
	900199	<input type="checkbox"/>	Manifold 5x, DN 25 - Manifold with wall mounting bracket, for 5 heating circuit modules, or alternatively for 4 pcs. heating circuit module and 1 pc. hot water tank loading module - Flow and Return are thermally separated, with EPP thermal insulation	1398,00
	00717.1	<input type="checkbox"/>	Tiled stove pump unit	994,00
■ must be ordered ■ make a choice □ optional				

Standard storage

from
page
327

	Art.-Nr.	Infos	Designation	Price
Free Installation extension board 'Heating circuits'				
	E006004-20	<input type="checkbox"/>	Extension board 'Heating circuits' In wall-mount box. For outdoor temperature controlled operation with 2 additional heating circuits - 2 pcs. surface sensors Pt 1000 for heating circuit flow line, with mounting clamp - incl. connection possibility for 2 heat metering systems in combination with UK 100090-01 - Connecting cable for data E013005-.. 3-wire required Precondition for this version: Boiler operation with EOS 6, Extension board 'Basic'	999,00
Hydraulic components				
	UK100090	<input type="checkbox"/>	Mixed heating circuit 1-6, DN 25 Heating circuit module with pump Wilo Yonos Para 25/6, for e.g. NT-type panel heaters, radiators, convectors or heating pipe systems (underfloor heating or wall-mount heating registers)	1005,50
	UK100090-01	<input type="checkbox"/>	Mixed heating circuit group 3,4,5,6 DN 25 with power measurement Heating circuit group with volume flow metering, with pump Wilo Yonos Para 25/6, for e.g. NT-type panel heaters, radiators, convectors or heating pipe systems (underfloor heating or wall-mount heating registers)	1410,00
Accessories for free installation				
	900197	<input type="checkbox"/>	Manifold 2x, DN 25 - Manifold with wall mounting bracket, for 2 heating circuit modules, or alternatively for 1 pc. heating circuit module and 1 pc. hot water tank loading module - Flow and Return are thermally separated, with EPP thermal insulation	457,00
	900198	<input type="checkbox"/>	Manifold 3x, DN 25 - Manifold with wall mounting bracket, for 3 heating circuit modules, or alternatively for 2 pcs. heating circuit module and 1 pc. hot water tank loading module - Flow and Return are thermally separated, with EPP thermal insulation	549,50
	900199	<input type="checkbox"/>	Manifold 5x, DN 25 - Manifold with wall mounting bracket, for 5 heating circuit modules, or alternatively for 4 pcs. heating circuit module and 1 pc. hot water tank loading module - Flow and Return are thermally separated, with EPP thermal insulation	1398,00
■ must be ordered ■ make a choice □ optional				

	Art.-Nr.	Infos	Designation	Price
Free installation of the extension board of power registration for heat generator				
	E006004-40	<input type="checkbox"/>	<p>Extension board 'Performance'</p> <p>In wall-mount box. For heat metering and balancing of a connected additional heating, e.g. oil/gas boiler or heat pump.</p> <p>- Connecting cable for data E013005-.. 3-wire required</p> <p>Precondition for this version: Boiler operation with EOS 6, Extension board 'Basic'</p> <p>If only the performance of the boiler should be recorded the extension board of Power registration can be connected directly to the EOS without the extension board Basic (EWP Basis).</p>	979,00



Hydraulic components				
		<input type="checkbox"/>	Performance Kit	
	900202		<p>for measurement of heat quantity</p> <p>Set capacity up to 15 kW</p> <p>consists of:</p> <ul style="list-style-type: none"> - flowmeter DN 15 - 2 contact sensors with clamping band 	244,50
	900203		<p>Set capacity 30-50 kW</p> <p>consisting of:</p> <ul style="list-style-type: none"> - Flowmeter DN 20 - 2 contact sensors with clamping band 	268,50
<p>■ must be ordered ■ make a choice □ optional</p>				

	Art.-Nr.	Infos	Designation	Price
Extension board for tiled stove performance metering				
	E006004-70	<input type="checkbox"/>	<p>Extension board for tiled stove performance metering</p> <ul style="list-style-type: none"> - Wall-mount box - 2 pcs. surface temperature sensor Pt 1000 - Extension kit for power measurement, with Huba sensor 5.0-85 l/min <p>- Power metering and balancing of an additionally connected heat generator or receiver is possible</p> <p>Caution: Combination is possible only with BRUNNER tiled stove pump unit (Art. No. 00717.1)</p> <p>Connecting cable for data E013005-... 3-wire required</p> <p>Precondition for this version: Boiler operation with EOS 6, Extension board 'Basic'</p> <p>If only the performance of the boiler should be recorded the extension board of Power registration can be connected directly to the EOS without the extension board Basic (EWP Basis).</p>	1336,00
<input checked="" type="checkbox"/> must be ordered <input type="checkbox"/> make a choice <input type="checkbox"/> optional				

Tiled stove pump unit

from
page
328

	Art.-Nr.	Infos	Designation	Price
Free installation of the extention board Oil / Gas / Solar				
	E006004-30	<input type="checkbox"/>	<p>Extention board Oil / Gas / Solar</p> <p>In-wall mount box. For intergration of a thermal solar system with separate circuits, and a switch-over function (e.g. zone valve) between hot water storage tank loading or loading of a buffer tank via solar heating. Coil control of a switching valve (e.g. zone valve) for connection of oil or gas heater (requires wiring ofr data transfer between the individual extension boards, with 3 wires)</p> <ul style="list-style-type: none"> - 1 x Pt 1000 temperature sensor for hot water storage with immersion sleeve DN 15 (1/2") - 1 x Pt 1000 boiler temperature sensore with immersion sleeve DN 15 (1/2") - 1 x Pt 1000 collector temperature sensor wiht immersion sleeve DN 15 (1/2") <p>Connecting cable for data E013005-.. 3-wire required</p> <p>Precondition for this version: Boiler operation with EOS 6, Extension board 'Basic'</p>	1133,00
<input checked="" type="checkbox"/> must be ordered <input checked="" type="checkbox"/> make a choice <input type="checkbox"/> optional				

	Art.-Nr.	Infos	Designation	Price
Accessories for free installation				
		<input type="checkbox"/>	Connection wiring Data universal connection wiring (CAN Bus) for data exchange between boiler, BHZ and all extension boards..	
	E013005-1		Connection wiring 0,7 m	23,50
	E013005-2		Connection wiring 2 m	27,50
	E013005-3		Connection wiring 3 m	30,50
	E013005-4		Connection wiring 4 m	33,00
	E013005-5		Connection wiring 5 m	37,50
	E013005-7		Connection wiring 7 m	43,50
	E013005-10		Connection wiring 10 m	56,00
			Connection wiring > 10 m up to max. 200 m by metre	
		<input type="checkbox"/>	Extension wiring for temperature sensor extension wiring with screen, for Pt 1000 temperature sensors	
	E013013-01		Extension wiring 3 m	45,50
	E013013-02		Extension wiring 5 m	52,00
	E013013-03		Extension wiring 10 m	75,50
	E013013-04		Extension wiring 15 m	93,50

flat

Tunnel

Additional door DHT

Eck

Heating Center



Iron Dog 01

	Art.-Nr.	No.	Price
Iron Dog 01	50000		2945,00

Energy efficiency class A

	Art.-Nr.	No.	Price
Heat protective panel (backwall) for Iron Dog 01	50130		149,00



Air supply box	Art.-Nr.	No.	Price
Air supply box	K006110		236,00



Aluflex hose	Art.-Nr.	No.	Price
Aluflex hose	N003054		62,50



Iron Dog 02

	Art.-Nr.	No.	Price
Iron Dog 02	K007088		3083,00

Energy efficiency class A

	Art.-Nr.	No.	Price
Heat protective panel (backwall) for Iron Dog 02	K007090		152,00



Air supply box	Art.-Nr.	No.	Price
Air supply box	K007101		255,00



Aluflex hose	Art.-Nr.	No.	Price
Aluflex hose	N003054		62,50



Iron Dog 04

	Art.-Nr.	No.	Price
Iron Dog 04	50030		4418,50

Energy efficiency class A



	Art.-Nr.	No.	Price
Air supply box			
Air supply box	K009160		304,00



	Art.-Nr.	No.	Price
Aluflex hose			
Aluflex hose	N003054		62,50



Iron Dog 06 with grill function

	Art.-Nr.	No.	Price
Iron Dog 06	K011001		8341,50

Energy efficiency index A +



Accessories	Art.-Nr.	No.	Price
Baking tray	K011152		162,00
Cooking grill (1 piece included in delivery of Iron Dog 06)	K011037		251,50
Double-enamelled cast iron oven-pan	K011151		175,50



Air supply box	Art.-Nr.	No.	Price
Air supply box	K011155		255,00



Aluflex hose	Price	No.	Price
Aluflex hose	N003054		62,50



Iron Dog 07

	Art.-Nr.	No.	Price
Iron Dog 07 firing door right	K012001-03		4888,50
Iron Dog 07 firing door left	K012001-04		4888,50

Energy efficiency index A +



Aluflex hose	Art.-Nr.	No.	Price
Aluflex hose	N003054		62,50



Baking oven Kirschgarten

Article description	Art.-Nr.	Price
Baking oven door Kirschgarten	10702	1131,50
Baking oven smoke pipe connection ø 180 mm	10280	483,50
Soot cleaning door 1½ tile with cast iron fittings and wooden knob	10617	314,50
Dial thermometer	900118	78,50



Dial thermometer

Mounting accessories

Soot cleaning door Art.-Nr.: 10617

	Frame external dimensions W x H in mm	Frame external dimensions W x H in mm	Dimensions of door opening W x H in mm
1 1/2-tile size	340 x 150 mm	295 x 115 mm	275 x 100 mm



Soot cleaning door

Baking oven Sailerhof



Article description	Art.-Nr.	Price
Baking oven door Sailerhof	10701	608,50
Baking oven smoke pipe connection ø 180 mm	10703	440,00
Soot cleaning door 1½ tile with cast iron fittings and wooden knob	10617	314,50
Dial thermometer	900118	78,50



Baking oven smoke pipe connection



Soot cleaning door



Dial thermometer

Baking oven Feuer-Iglu



Feuer-Iglu

Article description	Art.-Nr.	Price
Fire Igloo 950 with insulated lid	Q010048	2821,50
Cast iron door 2 wings, with connection block	Q010047	734,00
Dial thermometer 50 - 500 °C	900118	78,50
Damper ø 180 mm with recessed handle	900121	446,00



Cast iron doors with 2 wings



Dial thermometer



Damper ø 180 mm
with recessed handle



Baking oven Grannus



Grannus top cover for outdoor use



Side table for Grannus with support bearing

Baking oven Grannus

Article description	Art.-Nr.	Price
Baking oven Grannus	Q010079	5297,00
Consisting of: - Grannus thermal concrete cladding - Fire Igloo - lean door - 2 x dial thermometer		
Grannus top cover for outdoor use	Q010072	1343,50
Support bearing Grannus (set consisting of 2 pieces galvanized)	Q010102	691,50
Side table for Grannus (without cover plate)	Q010110	1619,00
Support bearing side board	Q010104	290,50



Fireplace grill 24/30

Available variants

Variant	Art.-Nr.	No.	Price
Fireplace grill 24/30, for smaller fireplaces and HKD 2.2	N006092		245,50



Fireplace grill 42/30

Available variants

Variant	Art.-Nr.	No.	Price
Fireplace grill 42/30, for bigger fireplaces	N006090		304,00

MAS

HKD



MAS Modular Accumulators - MAS 360 vertical

Set consists of:	Art.-Nr.	No.	Price
MAS 360 Accumulation stone		6	
Top cover, vertical MAS 360		1	

Additional options			
Reduction for missing cast iron dome when MAS is being used (in case of devices listed below)	D003362		-78,50
MAS 360 storage stone with bore for thermocouple (1 piece necessary for EAS/EOS devices)	10047		205,50
Cleaning brush MAS 110 mm	902248		50,00

Available variants:

MAS 360 suitable for:			
HKD 2.2 flat short HKD 2.2 round short HKD 2.6 short	SET211441		1438,00

flat

MAS Modular Accumulators - MAS 360 horizontal



Set consists of:	Art.-Nr.	No.	Price
MAS 360 Accumulation stone		5	
Top cover, horizontal MAS 360		1	

Additional options			
Reduction for missing cast iron dome when MAS is being used (in case of devices listed below)	D003362		-78,50
MAS 360 storage stone with bore for thermocouple (1 piece necessary for EAS/EOS devices)	10047		205,50
Cleaning brush MAS 110 mm	902248		50,00

Available variants:

MAS 360 suitable for:			
HKD 2.2 flat short HKD 2.2 round short HKD 2.6 short	SET211442		1436,50

Eck

Tunnel



MAS modular top-mount storage SET 440

Set consists of:	Art.-Nr.	No.	Price
MAS 440 Accumulation stone double-layered		5	
Cast iron dome MAS ø 180		1	
Mounting ring		1	

Additional options			
Exchange connectiong piece ø 200 mm	R009105		75,50
Exchange connectiong piece ø 160 mm	07137		75,50
Cleaning brush MAS 110 mm	902248		50,00

Available variants:

MAS 440 suitable for:			
HKD 2.2 flat HKD 2.2 round HKD 5.1 BKH 5.0 Flach/Tunnel 42-50 BKH 5.0 Flach/Tunnel 42-66 BKH 5.0 Flach/Tunnel 50-98 Stil-Kamin 62/76 Stil-Kamin 75/90 Stil-Kamin 53/88 Eck-Kamin 42/42/42 Eck-Kamin D/S 51/52/52 Eck-Kamin D/S 57/52/52 Eck-Kamin S 57/67/44 Eck-Kamin S 45/67/44 Eck-Kamin S 57//82/48 Eck-Kamin S 45/82/48	SET211444		2171,50



MAS modular top-mount storage SET 440

Set consists of:	Art.-Nr.	No.	Price
MAS 440 Accumulation stone double-layered		5	
Cast iron dome MAS ø 180		1	
Mounting ring		1	

Additional options			
Reduction for missing cast iron dome when MAS is being used (in case of devices listed below)	08287		-78,50
Exchange connectiong piece ø 200 mm	R009105		75,50
Exchange connectiong piece ø 160 mm	07137		75,50
Cleaning brush MAS 110 mm	902248		50,00

Available variants:

MAS 440 suitable for:			
HKD 6.1 HKD 2.2 round short DF 33	SET211446		2166,00



MAS modular top-mount storage SET 440

Set consists of:	Art.-Nr.	No.	Price
MAS 440 Accumulation stone double-layered		7	
Cast iron dome MAS ø 180		1	
Mounting ring		1	

Additional options

Exchange connecting piece ø 200 mm	R009105		75,50
Exchange connecting piece ø 160 mm	07137		75,50
Cleaning brush MAS 110 mm	902248		50,00

Available variants:

MAS 440 suitable for:			
HKD 7, HKD 8, HKD 11	SET212772		2730,50



MAS modular top-mount storage SET 440

Set consists of:	Art.-Nr.	No.	Price
MAS 440 Accumulation stone double-layered		3	
Cast iron dome MAS ø 200		1	
Mounting ring		1	

Additional options

Cleaning brush MAS 110 mm	902248		50,00
---------------------------	--------	--	-------

Available variants:

MAS 440 suitable for:			
Panorama-Kamin 51/50/50/50	SET213097		1607,00

MSS

Art.-Nr.	Identification of parts	Designation	Price
MSS double-layered			
R013066	1	MSS heat storage module with lining 10 cm, double-layered	140,00
R013065	2	MSS heat storage module with lining 20 cm, double-layered	201,00
R013063	3	MSS T-piece with lining, double-layered	303,50
R013061	4	MSS elbow 90° with lining, double-layered	241,00
R013126	5	MSS inlet block ø 180, double-layered	194,50
R013020	6	MSS steel tape ring, packaging steel tape 16 x 0,5	6,00
R013020-25	6	MSS steel tape ring set 25 pcs. in box	128,00
R013169	7	MSS 3-way elbow 90° ø180, double-layer	409,50
900133		MSS glue Thermofix 1000 1 kg	14,50
900133K		MSS glue in box with 16 pcs. / 1 kg each	234,50

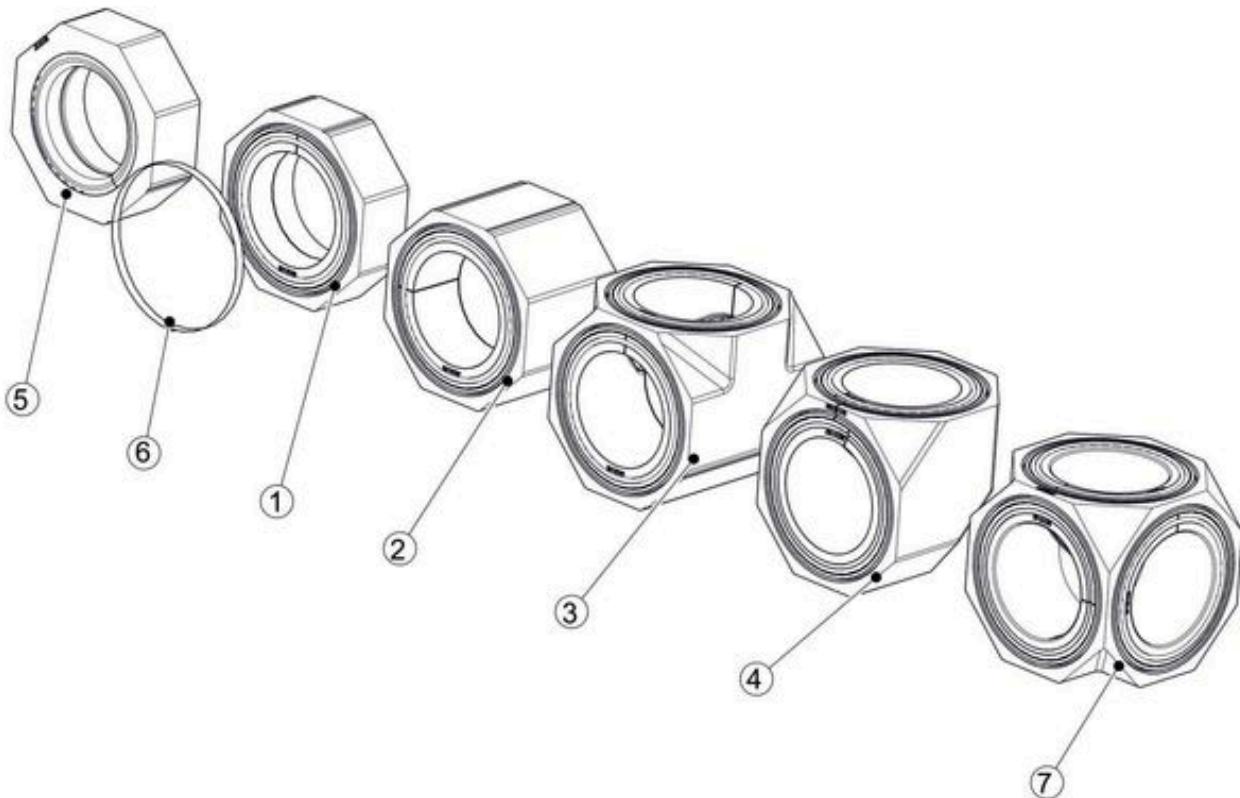

Art.-Nr.	Identification of parts	Designation	Price
MSS single-layered			
R013002	1	MSS heat storage module 10 cm	60,50
R013001	2	MSS heat storage module 20 cm	107,50
R013004	3	MSS T-piece 90°	140,50
R013165	22	MSS elbow 45° single-layer	151,50
R013005	4	MSS elbow 90°	151,50
R013017	5	MSS elbow 90° with cleanout right	194,50
R013018	6	MSS elbow 90° with cleanout left	194,50
R013019	7	MSS elbow 90° with cleanout top	194,50
R013068	8	MSS outlet block ø 160 with sealing	58,00
R013067	9	MSS outlet block ø 180 with sealing	58,00
R013109	11	MSS heat storage module 10 cm with damper flap	380,50
R013016	13	MSS heat storage module 20 cm with cleanout	136,50
R013079	18	MSS cleanout cover with sealing	37,50
R013020	19	MSS steel tape ring, packaging steel tape 16 x 0,5	6,00
R013020-25	19	MSS steel tape ring set 25 pcs. in box	128,00
900133		MSS glue Thermofix 1000 1 kg	14,50
900133K		MSS glue in box with 16 pcs. / 1 kg each	234,50

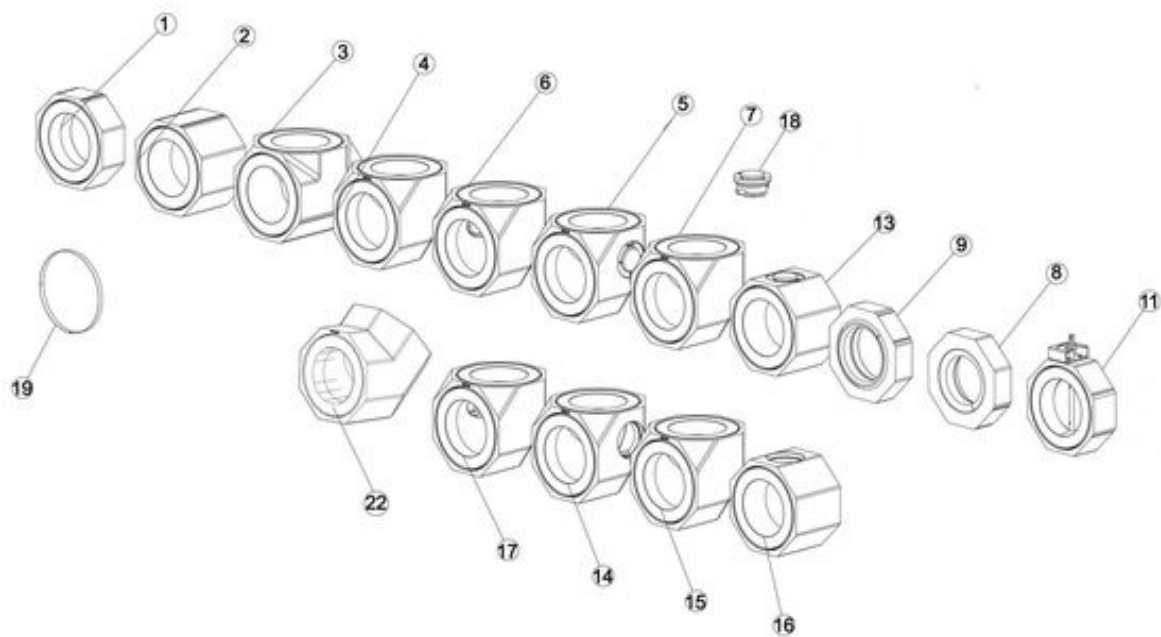

MSS Bypass

If you need to create a bypass, you can set together two MSS with cleanouts, but without using a cleanout cover. In the cleaning openings a bypass has to be inserted. (see MSS assembly instructions)

Art.-Nnr.	Identification of parts	Designation	Price
MSS double-layered			
R013073	10	MSS bypass 30 with sealings	44,00
R013074	12	MSS bypass 40 with sealings	44,00
R013009	17	MSS elbow 90° with opening left	157,50
R013006	14	MSS elbow 90° with opening right	157,50
R013007	15	MSS elbow 90° with opening top	157,50
R013003	16	MSS heat storage module 20 cm with opening	126,00

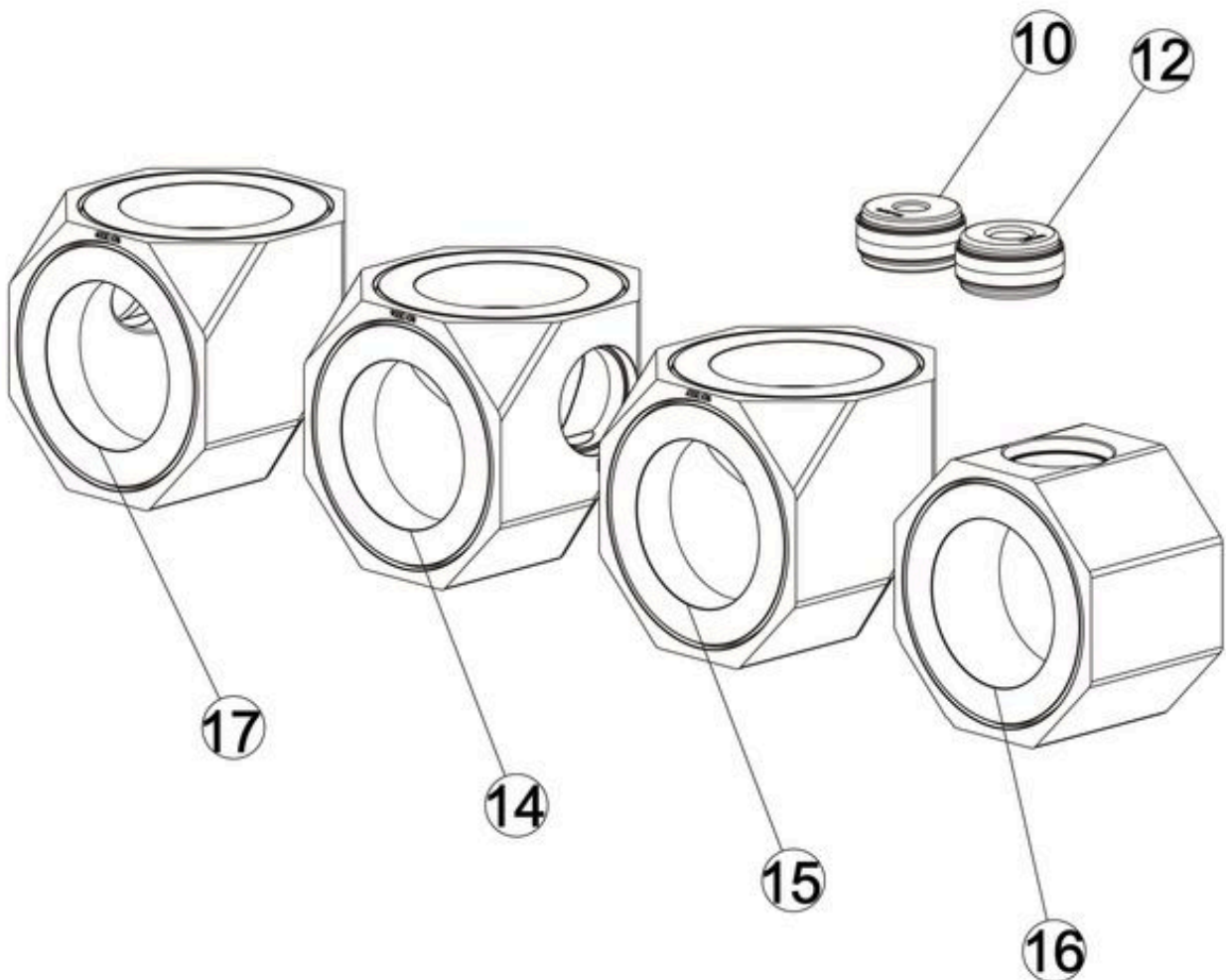

MSS

HKD

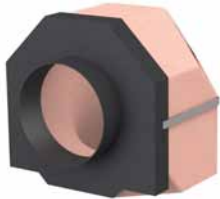
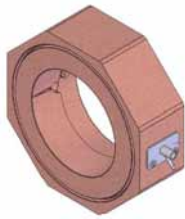

flat

MSS with connection for thermocouple and negative pressure hose

	Art.-Nr.	Price
MSS heat storage module 10 cm with connecting plate for T1, T3 USA (for temperature and negative pressure)	R013133	186,50
MSS inlet adapter for MSS elbow 90 °	R013138	313,50
MSS outlet adapter for MSS Bogen 90 °	R013145	218,00

Art.-Nr.

Identification of parts

Designation

Price

MSS double-layered			
Art.-Nr.	Identification of parts	Designation	Price
R013108	1	MSSI insulating block 30 x 30 cm	46,00
R013107	2	MSSI insulating block 20 x 30 cm	37,50
R013123	3	MSS base plate 75 30 x 30 cm	46,00
R013124	4	MSS base plate 100 30 x 30 cm	49,00

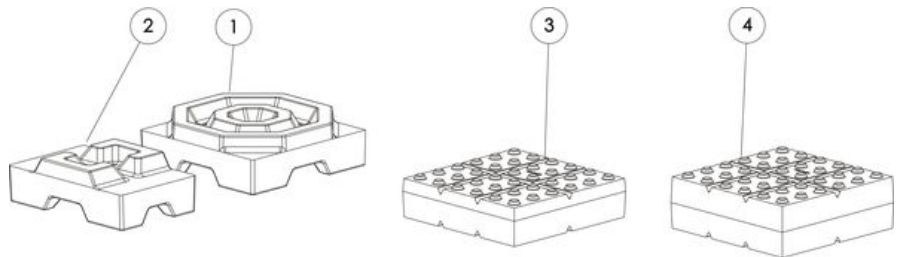

Accessories



	Art.-Nr.	Price
MSS handle with rotating part	R013170	60,50

Eck

Tunnel

MSS Pallets

Art.-Nr.	Pcs./Pallet	Designation	Price
R013018P	16	MSS elbow 90° with cleanout left	2795,00
R013019P	16	MSS elbow 90° with cleanout top	2795,00
R013017P	16	MSS elbow 90° with cleanout right	2795,00
R013005P	16	MSS elbow 90°	2184,50
R013165P	12	MSS elbow 45°	1692,50
R013001P	16	MSS heat storage module 20 cm	1540,50
R013002P	32	MSS heat storage module 10 cm	1742,50
R013061P	16	MSS elbow 90° with lining, double-layered	3475,50
R013004P	16	MSS T-piece 90°	2039,50
R013063P	16	MSS T-piece with lining, double-layered	4370,50
R013067P	16	MSS outlet block ø 180 with sealing	826,00
R013066P	32	MSS heat storage module with lining 10 cm, double-layered	4054,00
R013065P	32	MSS heat storage module with lining 20 cm, double-layered	5800,00
R013126P	40	MSS inlet block ø 180, double-layered	6988,00
R013108P	32	MSSI insulating block 30 x 30 cm	1313,00
R013107P	48	MSSI insulating block 20 x 30 cm	1630,00
R013123P	40	MSS base plate 75, 30 x 30 cm	1640,50
R013124P	32	MSS base plate 100, 30 x 30 cm	1536,50

HKD

Flat

Eck

Tunnel

MAS, MSS, GNF

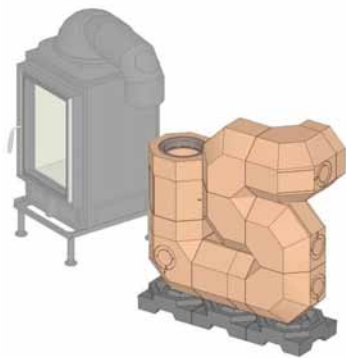

SET213010

MSS heat storage set standing next for HKD stoves 296 kg

Set consists of:	Art.-Nr.	No.	Price
MSS accumulation stone 10 cm	R013002	2	
MSS accumulation stone 20 cm	R013001	2	
MSS elbow 90° with cleanout left	R013018	1	
MSSI insulating block 30x30 cm	R013108	3	
MSS elbow 90°	R013005	1	
MSS elbow 90° with cleanout top	R013019	3	
MSS elbow 90° with opening top	R013007	1	
MSS inlet block ø 180, double-layered	R013126	1	
MSS outlet block ø 160 with sealing	R013068	1	
MSS heat storage module 20 cm with opening	R013003	1	
MSS steel tape ring	R013020	12	
MSS bypass 30 with sealings	R013073	1	
MSS glue Thermofix 1000 1 kg	900133	2	
MSS handle with rotating part	R013170	1	

Available variants:

MSS heat storage set standing next suitable for:			
HKD 7, 8 HKD 11 HKD 4.1, 5.1, 6.1 HKD 2.2, HKD 2.2 XL	SET213010		2142,00

Additional options			
SET socket stones	SET213014		284,50

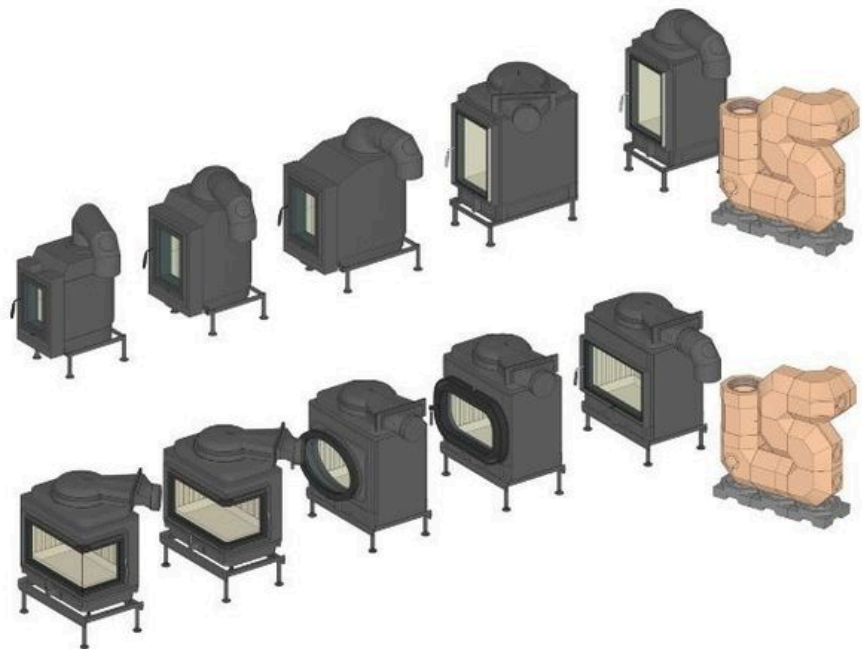

MSS heat storage set standing next for HKD stoves 426 kg

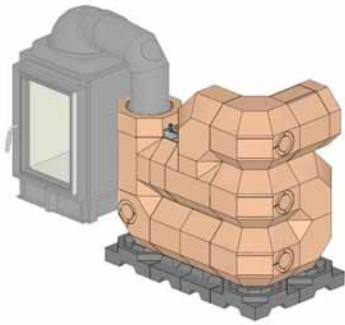

SET213011

Set consists of:	Art.-Nr.	No.	Price
MSS inlet block ø 180, double-layered	R013126	1	
MSS heat storage module 10 cm with damper flap	R013109	1	
MSS outlet block ø 160 with sealing	R013068	1	
MSS T-piece 90°	R013004	2	
MSS elbow 90°	R013005	4	
MSS elbow 90° with cleanout top	R013019	3	
MSS heat storage module 10 cm	R013002	1	
MSS heat storage module 20 cm	R013001	3	
MSS elbow 90° with cleanout left	R013018	1	
MSS steel tape ring	R013020	17	
MSS glue Thermofix 1000 1 kg	900133	3	
MSSI insulating block 30x30 cm	R013108	3	
MSSI insulating block 20x30 cm	R013107	2	
MSS handle with rotating part	R013170	1	
Stainless steel handle for damper flaps / flue gas flaps	10275	1	

Available variants:

MSS heat storage set standing next suitable for:	Art.-Nr.	No.	Price
HKD 7, 8 HKD 11 HKD 4.1, 5.1, 6.1 HKD 2.2, HKD 2.2 XL	SET213011		3284,00

Additional options	Art.-Nr.	No.	Price
SET socket stones	SET213015		244,00

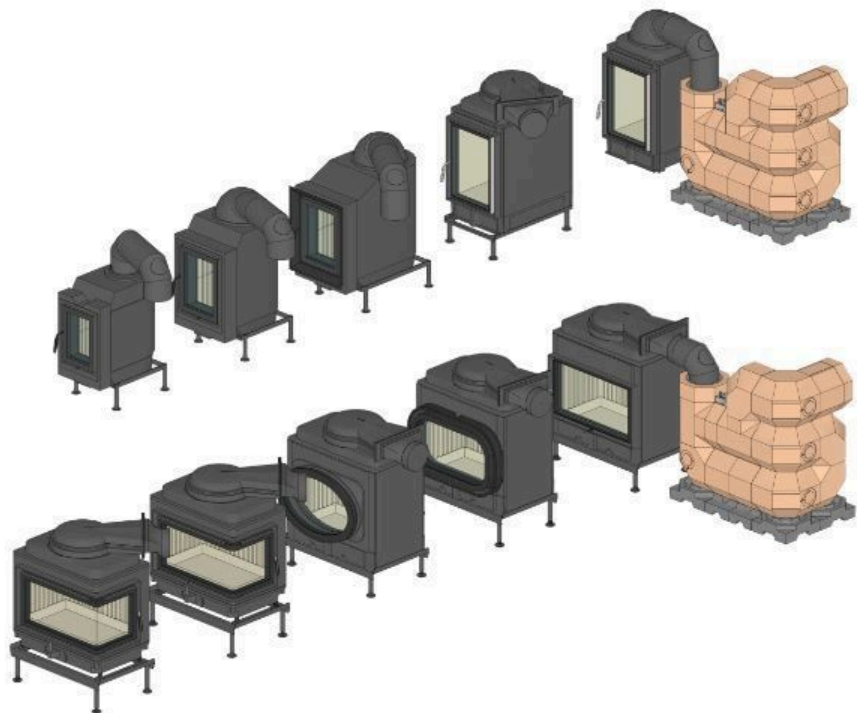

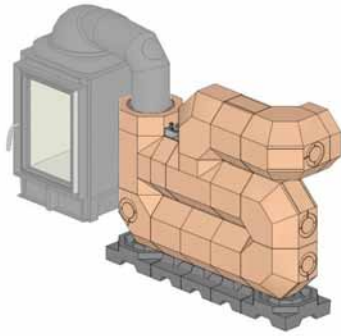

SET213012

MSS heat storage set standing next for HKD stoves 395 kg

Set consists of:	Art.-Nr.	No.	Price
MSS inlet block ø 180, double-layered	R013126	1	
MSS accumulation stone 10 cm	R013109	1	
MSS outlet block ø 160 with sealing	R013068	1	
MSS T-piece 90°	R013004	2	
MSS heat storage module 20 cm	R013001	6	
MSS elbow 90° with cleanout top	R013019	3	
MSS heat storage module 10 cm	R013002	1	
MSS elbow 90°	R013005	1	
MSS elbow 90° with cleanout left	R013018	1	
MSS handle with rotating part	R013170	1	
MSS steel tape ring	R013020	17	
MSS glue Thermofix 1000 1 kg	900133	3	
MSSI insulating block 30x30 cm	R013108	2	
MSSI insulating block 20x30 cm	R013107	3	
Stainless steel handle for damper flaps / flue gas flaps	10275	1	

Available variants:

MSS heat storage set standing next suitable for:			
HKD 7, 8 HKD 11 HKD 4.1, 5.1, 6.1 HKD 2.2, HKD 2.2 XL	SET213012		3143,00



MSS heat storage set standing next for HKD stoves 211,5 kg

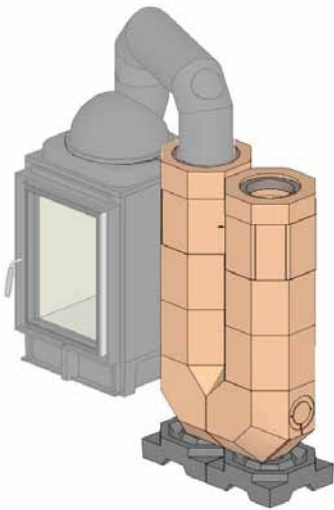

SET213013

Set consists of:	Art.-Nr.	No.	Price
MSS inlet block ø 180, double-layered	R013126	1	
MSS outlet block ø 160 with sealing	R013068	1	
MSS elbow 90°	R013005	1	
MSS heat storage module 20 cm	R013001	4	
MSS elbow 90° with cleanout top	R013019	1	
MSS heat storage module 20 cm with opening	R013003	2	
MSS bypass 30 with sealings	R013073	1	
MSS steel tape ring	R013020	9	
MSS glue Thermofix 1000 1 kg	900133	2	
MSSI insulating block 30x30 cm	R013108	2	
MSS handle with rotating part	R013170	1	

Available variants:

MSS heat storage set standing next suitable for:	SET213013	1557,50
HKD 6.1 HKD 7, 8 HKD 11 HKD 4.1, 5.1 HKD 2.2		

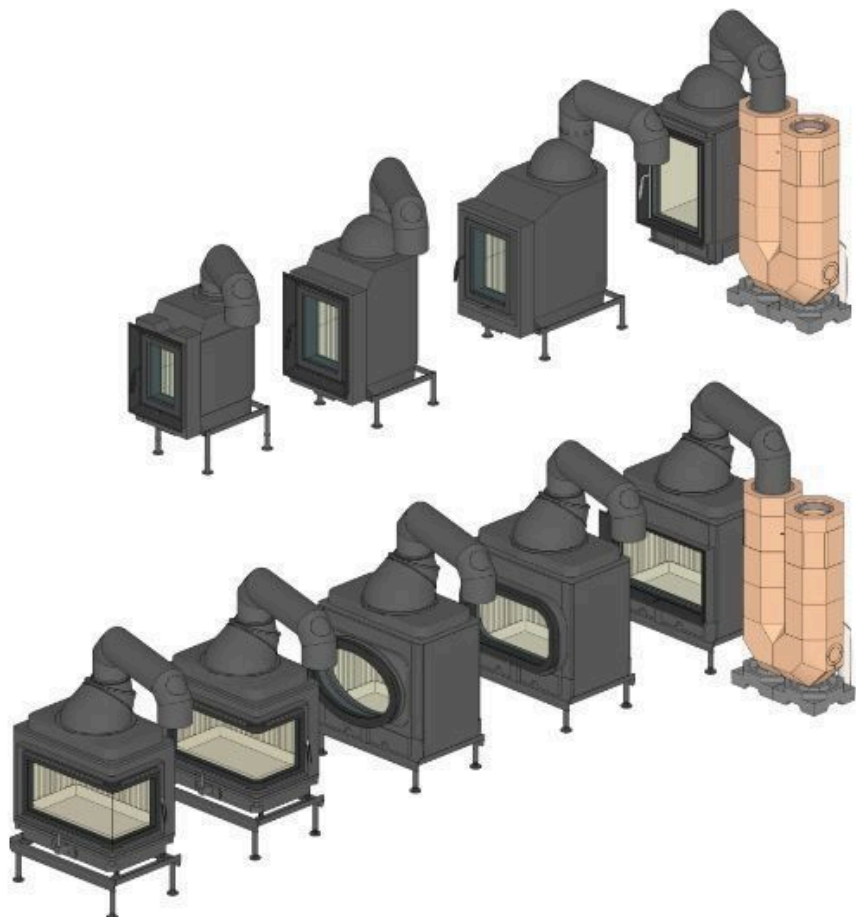

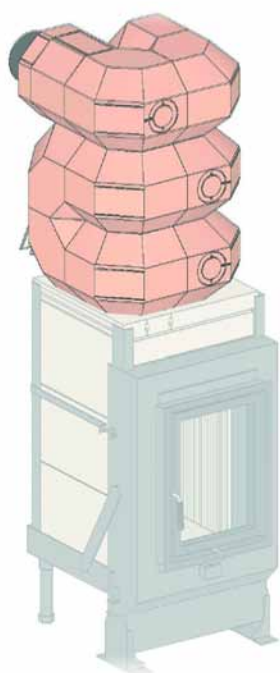

MSS heat storage set standing on top 400 kg

Set consists of:	Art.-Nr.	No.	Price
Accumulation stone MSS connecting block / GOF top cover	G013196	1	
MSS elbow 90° with lining, double-layered	R013061	1	
MSS elbow 90° with cleanout top	R013019	3	
MSS outlet block ø 180 with sealing	R013067	1	
MSS heat storage module 20 cm	R013001	1	
MSS elbow 90°	R013005	6	
MSS steel tape ring, packaging steel tape 16 x 0,5	R013020	13	
MSS glue Thermofix 1000 1 kg	900133	2	
MSS elbow 90° with cleanout left	R013018	1	
MSS handle with rotating part	R013170	1	

Available variants:

MSS heat storage set standing on top suitable for:			
GOF 37x42 + GOT 52/37-ZL side-opening door	SET211451		2463,00

With the MSS set a flue outlet can be realized either to the left or right side.

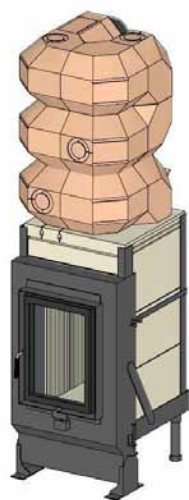

MSS heat storage set standing on top 300 kg

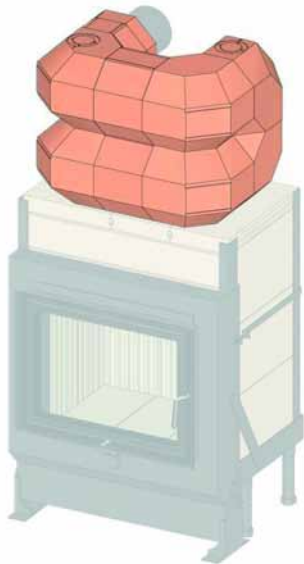

Set consists of:	Art.-Nr.	No.	Price
Accumulation stone MSS connecting block / GOF top cover	G013196	1	
MSS elbow 90° with lining, double-layered	R013061	1	
MSS elbow 90° with cleanout top	R013019	1	
MSS outlet block ø 180 with sealing	R013067	1	
MSS heat storage module 10 cm	R013002	1	
MSS elbow 90°	R013005	4	
MSS elbow 90° with cleanout left	R013018	1	
MSS steel tape ring, packaging steel tape 16 x 0,5	R013020	11	
MSS glue Thermofix 1000 1 kg	900133	2	
MSS heat storage module 20 cm	R013001	2	
MSS handle with rotating part	R013170	1	

Available variants:

MSS heat storage set standing on top suitable for:		
GOF 66x42 + GOT 51/67-ZL side-opening door	SET211412	1927,50

With the MSS set a flue outlet can be realized either to the left or right side.

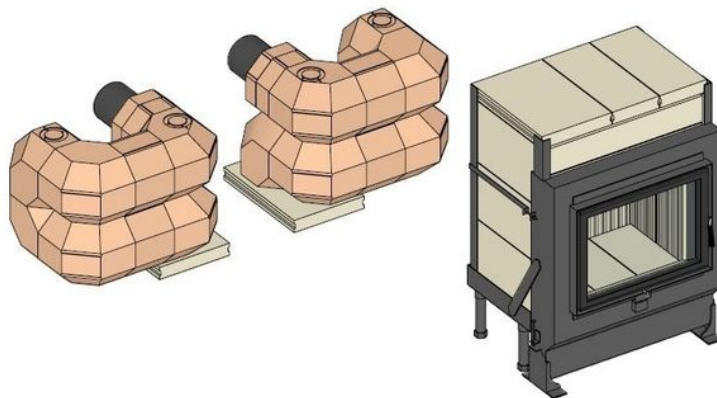



MSS heat storage set standing on top 270 kg

Set consists of:	Art.-Nr.	No.	Price
Accumulation stone MSS connecting block / GOF top cover	G013196	1	
MSS elbow 90° with lining, double-layered	R013061	1	
MSS elbow 90° with cleanout top	R013019	2	
MSS outlet block ø 180 with sealing	R013067	1	
MSS heat storage module 20 cm	R013001	1	
MSS elbow 90°	R013005	3	
MSS steel tape ring, packaging steel tape 16 x 0,5	R013020	9	
MSS glue Thermofix 1000 1 kg	900133	1	
MSS elbow 90° with cleanout right	R013017	1	
MSS handle with rotating part	R013170	1	

Available variants:

MSS heat storage set standing on top suitable for:			
GOF 37x37 + GOT HKD 6.1	SET211453		1776,50
GOF 37x37 + GOT HKD 5.1/12			

With the MSS set a flue outlet can be realized either to the left or right side.

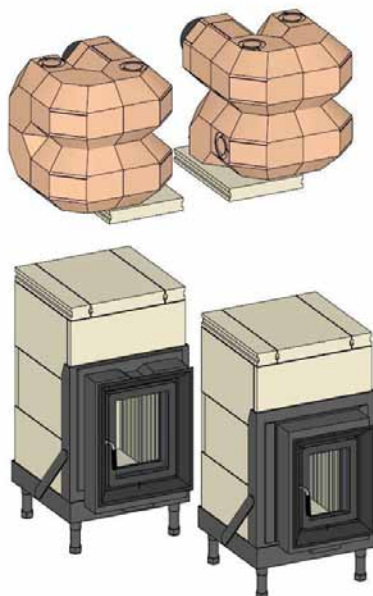

MSS heat storage set standing next 410 kg

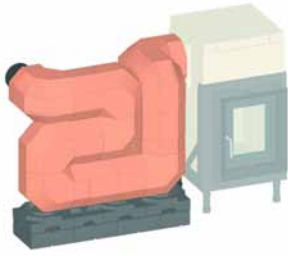

Set consists of:	Art.-Nr.	No.	Price
Accumulation stone MSS connecting block / GOF side	G015107	1	
MSS elbow 90° with lining, double-layered	R013061	1	
MSS outlet block ø 180 with sealing	R013067	1	
MSS heat storage module 10 cm	R013002	2	
MSS elbow 90°	R013005	3	
MSS steel tape ring, packaging steel tape 16 x 0,5	R013020	18	
MSS glue Thermofix 1000 1 kg	900133	2	
MSS heat storage module 20 cm	R013001	5	
MSSI insulating block 30x30 cm	R013108	3	
MSSI insulating block 20x30 cm	R013107	1	
MSS elbow 90° with opening left	R013009	1	
MSS elbow 90° with opening top	R013007	1	
MSS bypass 30 with sealings	R013073	1	
MSS heat storage module with lining 10 cm, double-layered	R013066	1	
MSS base plate 100 30x30 cm	R013124	4	
MSS elbow 90° with cleanout top	R013019	2	
MSS handle with rotating part	R013170	1	

Available variants:

MSS heat storage set standing on top suitable for:			
GOF 37x37 + GOT HKD 6.1	SET211457		3024,50
GOF 37x37 + GOT HKD 5.1/12			

The MSS accumulation block can be mounted either to the left or right side of the GOF

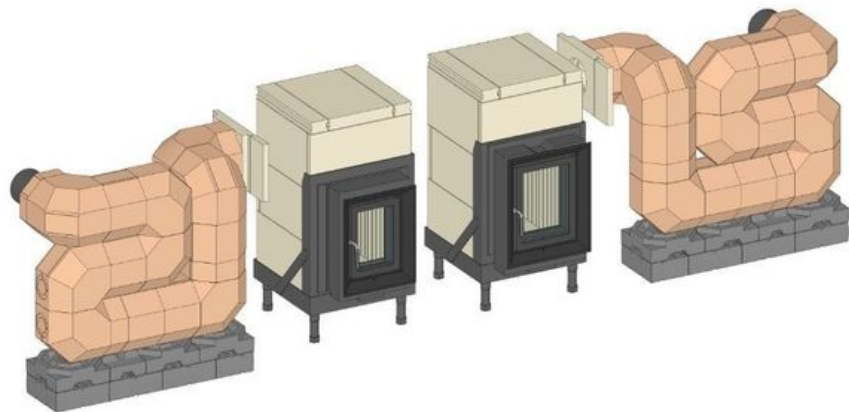

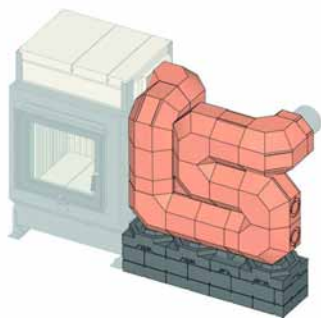

MSS heat storage set standing next 410 kg

Set consists of:	Art.-Nr.	No.	Price
Accumulation stone MSS connecting block / GOF side	G015107	1	
MSS elbow 90° with lining, double-layered	R013061	1	
MSS elbow 90° with cleanout top	R013019	2	
MSS outlet block ø 180 with sealing	R013067	1	
MSS heat storage module 10 cm	R013002	2	
MSS elbow 90°	R013005	3	
MSS steel tape ring, packaging steel tape 16 x 0,5	R013020	18	
MSS glue Thermofix 1000 1 kg	900133	3	
MSS heat storage module 20 cm	R013001	5	
MSSI insulating block 30x30 cm	R013108	3	
MSSI insulating block 20x30 cm	R013107	1	
MSS elbow 90° with opening left	R013009	1	
MSS elbow 90° with opening top	R013007	1	
MSS bypass 30 with sealings	R013073	1	
MSS heat storage module with lining 10 cm, double-layered	R013066	1	
MSS base plate 75 30x30 cm	R013123	4	
MSS base plate 100 30x30 cm	R013124	4	
MSS handle with rotating part	R013170	1	

Available variants:

MSS heat storage set standing next suitable for:			
GOF 37x42 + GOT 52/37-ZL side-opening door	SET211417		3223,50
GOF 55x42 + GOT 51/67-ZL side-opening door			

The MSS accumulation block can be mounted either to the left or right side of the GOF

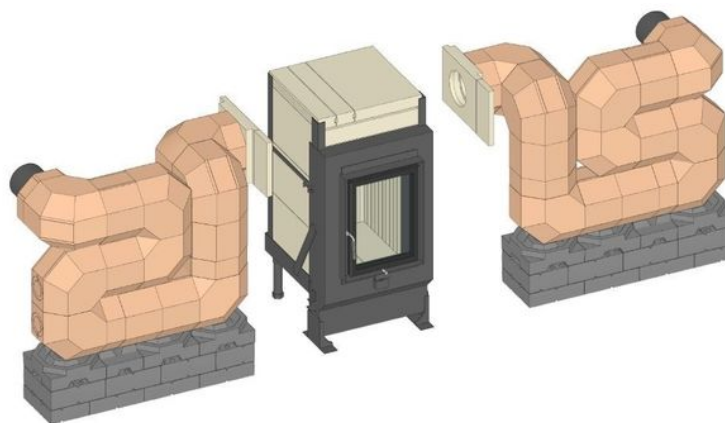

MSS heat storage set standing next (bank) 390 kg

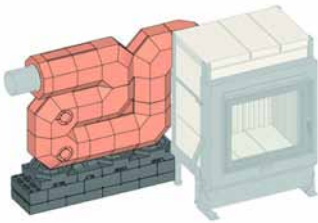

Set consists of:	Art.-Nr.	No.	Price
Accumulation stone MSS connecting block / GOF side	G015107	1	
MSS elbow 90° with lining, double-layered	R013061	1	
MSS outlet block ø 180 with sealing	R013067	1	
MSS heat storage module 10 cm	R013002	2	
MSS elbow 90°	R013005	2	
MSS steel tape ring, packaging steel tape 16 x 0,5	R013020	17	
MSS glue Thermofix 1000 1 kg	900133	3	
MSS heat storage module 20 cm	R013001	6	
MSSI insulating block 30x30 cm	R013108	3	
MSSI insulating block 20x30 cm	R013107	1	
MSS elbow 90° with opening top	R013007	2	
MSS bypass 30 with sealings	R013073	1	
MSS base plate 75 30x30 cm	R013123	4	
MSS base plate 100 30x30 cm	R013124	4	
MSS elbow 90° with cleanout right	R013017	2	
MSS handle with rotating part	R013170	1	

Available variants:

MSS heat storage set standing next suitable for:			
GOF 37x42 + GOT 52/37-ZL side-opening door	SET211418		3033,50
GOF 66x42 + GOT 51/67-ZL side-opening door			

The MSS accumulation block can be mounted either to the left or right side of the GOF

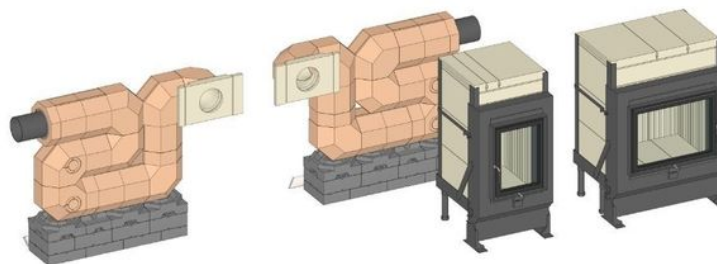

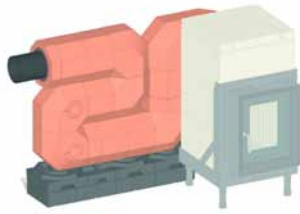

MSS heat storage set standing next (bank) 390 kg

Set consists of:	Art.-Nr.	No.	Price
Accumulation stone MSS connecting block / GOF side	G015107	1	
MSS elbow 90° with lining, double-layered	R013061	1	
MSS outlet block ø 180 with sealing	R013067	1	
MSS heat storage module 10 cm	R013002	2	
MSS elbow 90°	R013005	2	
MSS steel tape ring, packaging steel tape 16 x 0,5	R013020	17	
MSS glue Thermofix 1000 1 kg	900133	3	
MSS heat storage module 20 cm	R013001	6	
MSSI insulating block 30x30 cm	R013108	3	
MSSI insulating block 20x30 cm	R013107	1	
MSS elbow 90° with opening top	R013007	2	
MSS bypass 30 with sealings	R013073	1	
MSS base plate 100 30x30 cm	R013124	4	
MSS elbow 90° with cleanout right	R013017	2	
MSS handle with rotating part	R013170	1	

Available variants:

MSS heat storage set standing next suitable for:			
GOF 37x37+ GOT HKD 5.1/12 GOF 37x37 + GOT HKD 6.1	SET211459		2849,00

The MSS accumulation block can be mounted either to the left or right side of the GOF

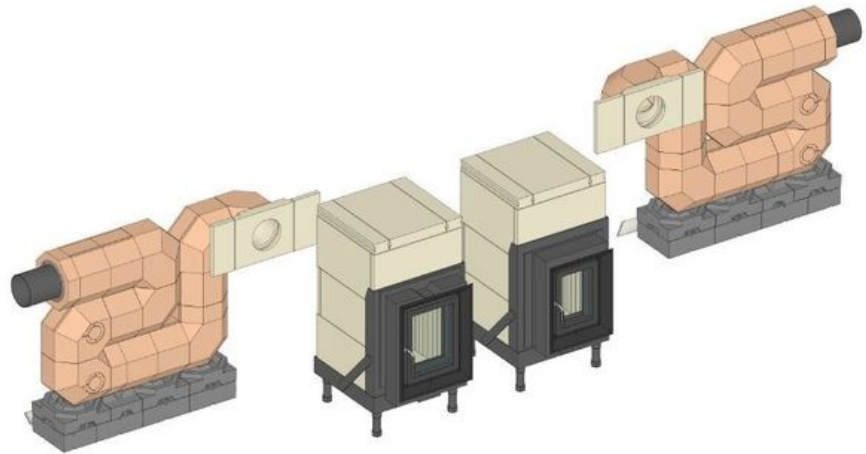

MSS heat storage set standing next 430 kg

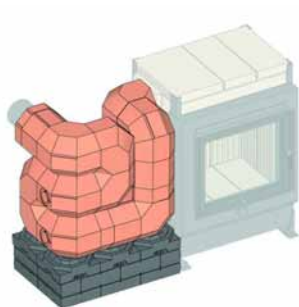

Set consists of:	Art.-Nr.	No.	Price
Accumulation stone MSS connecting block / GOF side	G015107	1	
MSS elbow 90° with lining, double-layered	R013061	1	
MSS elbow 90° with cleanout top	R013019	2	
MSS outlet block ø 180 with sealing	R013067	1	
MSS heat storage module 10 cm	R013002	2	
MSS elbow 90°	R013005	5	
MSS steel tape ring, packaging steel tape 16 x 0,5	R013020	17	
MSS glue Thermofix 1000 1 kg	900133	3	
MSS heat storage module 20 cm	R013001	3	
MSSI insulating block 30x30 cm	R013108	4	
MSS elbow 90° with opening left	R013009	1	
MSS elbow 90° with opening top	R013007	1	
MSS bypass 30 with sealings	R013073	1	
MSS heat storage module with lining 10 cm, double-layered	R013066	1	
MSS base plate 75 30x30 cm	R013123	4	
MSS base plate 100 30x30 cm	R013124	4	
MSS handle with rotating part	R013170	1	

Available variants:

MSS heat storage set standing next suitable for:			
GOF 37x42 + GOT 52/37-ZL side-opening door	SET211420		3314,50
GOF 66x42 + GOT 51/67-ZL side-opening door			

The MSS accumulation block can be mounted either to the left or right side of the GOF

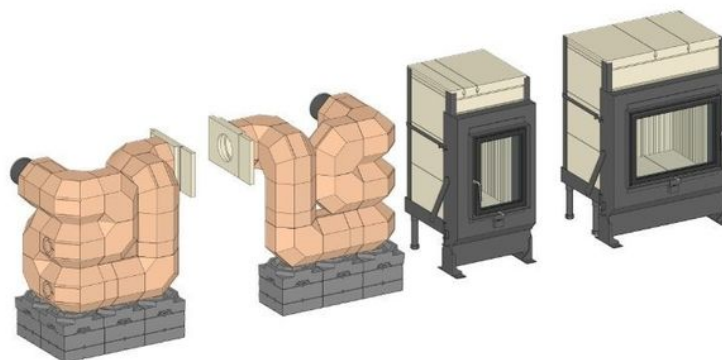

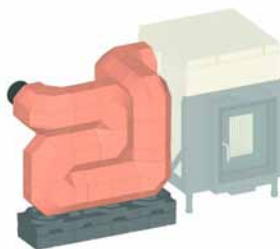

MSS heat storage set standing next 430 kg

Set consists of:	Art.-Nr.	No.	Price
Accumulation stone MSS connecting block / GOF side	G015107	1	
MSS elbow 90° with lining, double-layered	R013061	1	
MSS outlet block ø 180 with sealing	R013067	1	
MSS heat storage module 10 cm	R013002	2	
MSS elbow 90°	R013005	3	
MSS steel tape ring, packaging steel tape 16 x 0,5	R013020	19	
MSS glue Thermofix 1000 1 kg	900133	3	
MSS heat storage module 20 cm	R013001	6	
MSSI insulating block 30x30 cm	R013108	3	
MSSI insulating block 20x30 cm	R013107	1	
MSS elbow 90° with opening left	R013009	1	
MSS elbow 90° with opening top	R013007	1	
MSS bypass 30 with sealings	R013073	1	
MSS heat storage module with lining 10 cm, double-layered	R013066	1	
MSS base plate 100 30x30 cm	R013124	4	
MSS elbow 90° with cleanout top	R013019	2	
MSS handle with rotating part	R013170	1	

Available variants:

MSS heat storage set standing next suitable for:			
GOF 37x37+ GOT HKD 5.1/12	SET211458		3152,00
GOF 37x37 + GOT HKD 6.1			

The MSS accumulation block can be mounted either to the left or right side of the GOF

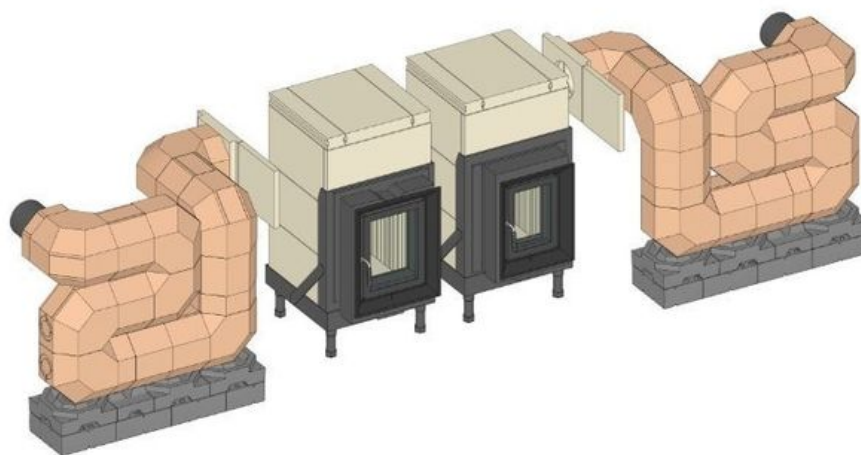

MSS heat storage set standing next 430 kg



Set consists of:	Art.-Nr.	No.	Price
Accumulation stone MSS connecting block / GOF side	G015107	1	
MSS elbow 90° with lining, double-layered	R013061	1	
MSS outlet block ø 180 with sealing	R013067	1	
MSS heat storage module 10 cm	R013002	2	
MSS elbow 90°	R013005	5	
MSS steel tape ring, packaging steel tape 16 x 0,5	R013020	17	
MSS glue Thermofix 1000 1 kg	900133	3	
MSS heat storage module 20 cm	R013001	3	
MSSI insulating block 30x30 cm	R013108	4	
MSS elbow 90° with opening top	R013007	1	
MSS bypass 30 with sealings	R013073	1	
MSS base plate 100 30x30 cm	R013124	4	
MSS heat storage module with lining 10 cm, double-layered	R013066	1	
MSS elbow 90° with cleanout top	R013019	2	
MSS elbow 90° with opening left	R013009	1	
MSS handle with rotating part	R013170	1	

Available variants:

MSS heat storage set standing next suitable for:		
GOF 37x37+ GOT HKD 5.1/12	SET211460	3130,00
GOF 37x37 + GOT HKD 6.1		

The MSS accumulation block can be mounted either to the left or right side of the GOF

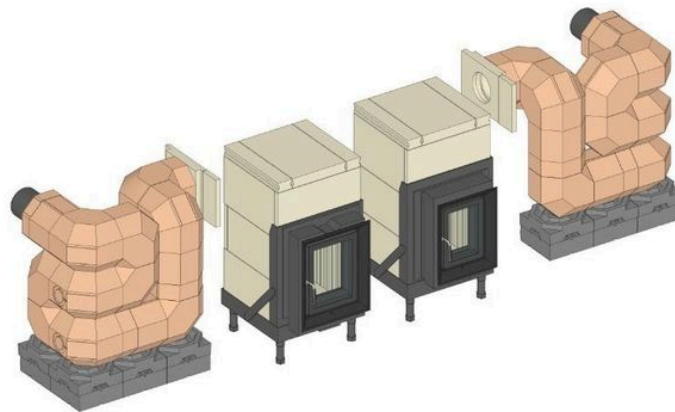

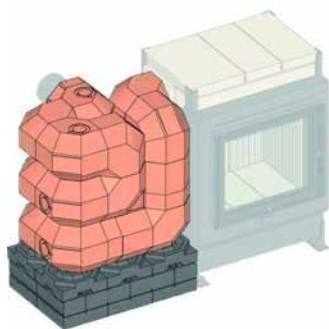

MSS heat storage set standing next 530 kg

Set consists of:	Art.-Nr.	No.	Price
Accumulation stone MSS connecting block / GOF side	G015107	1	
MSS elbow 90° with lining, double-layered	R013061	1	
MSS elbow 90° with cleanout top	R013019	2	
MSS outlet block ø 180 with sealing	R013067	1	
MSS heat storage module 10 cm	R013002	2	
MSS elbow 90°	R013005	7	
MSS steel tape ring, packaging steel tape 16 x 0,5	R013020	21	
MSS glue Thermofix 1000 1 kg	900133	3	
MSS heat storage module 20 cm	R013001	2	
MSSI insulating block 30x30 cm	R013108	6	
MSS elbow 90° with opening left	R013009	1	
MSS elbow 90° with opening top	R013007	1	
MSS bypass 30 with sealings	R013073	1	
MSS heat storage module with lining 10 cm, double-layered	R013066	1	
MSS base plate 75 30x30 cm	R013123	6	
MSS base plate 100 30x30 cm	R013124	6	
MSS elbow 90° with cleanout right	R013017	2	
MSS handle with rotating part	R013170	1	

Available variants:

MSS heat storage set standing next suitable for:			
GOF 37x42 + GOT 52/37-ZL side-opening door	SET211421		4204,00
GOF 66x42 + GOT 51/67-ZL side-opening door			

The MSS accumulation block can be mounted either to the left or right side of the GOF

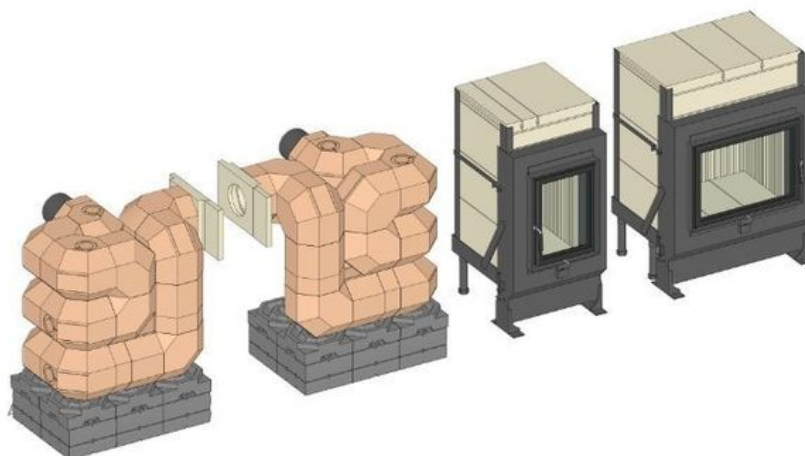

MSS heat storage set standing next 530 kg

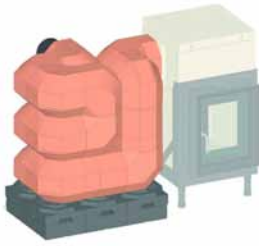

Set consists of:	Art.-Nr.	No.	Price
Accumulation stone MSS connecting block / GOF side	G015107	1	
MSS elbow 90° with lining, double-layered	R013061	1	
MSS outlet block ø 180 with sealing	R013067	1	
MSS heat storage module 10 cm	R013002	2	
MSS elbow 90°	R013005	7	
MSS steel tape ring, packaging steel tape 16 x 0,5	R013020	21	
MSS glue Thermofix 1000 1 kg	900133	3	
MSS heat storage module 20 cm	R013001	2	
MSSI insulating block 30x30 cm	R013108	6	
MSS elbow 90° with opening top	R013007	1	
MSS bypass 30 with sealings	R013073	1	
MSS base plate 100 30x30 cm	R013124	6	
MSS heat storage module with lining 10 cm, double-layered	R013066	1	
MSS elbow 90° with cleanout top	R013019	2	
MSS elbow 90° with opening left	R013009	1	
MSS elbow 90° with cleanout right	R013017	2	
MSS handle with rotating part	R013170	1	

Available variants:

MSS heat storage set standing next suitable for:			
GOF 37x37+ GOT HKD 5.1/12	SET211462		3927,50
GOF 37x37 + GOT HKD 6.1			

The MSS accumulation block can be mounted either to the left or right side of the GOF

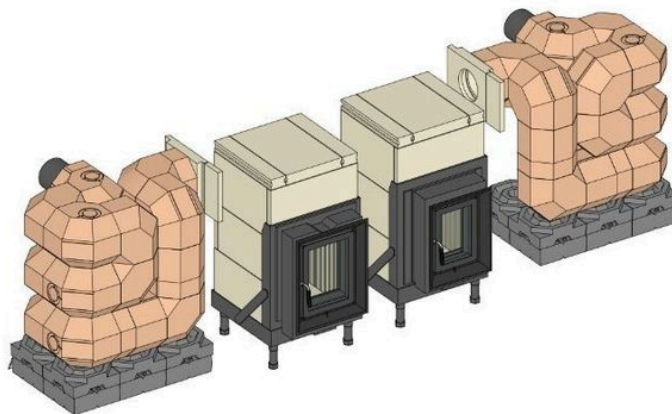

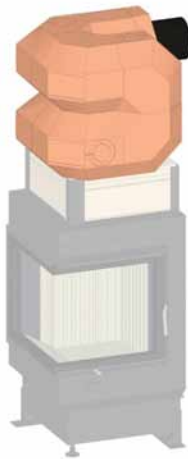

MSS heat storage set standing on top 280 kg

Set consists of:	Art.-Nr.	No.	Price
Accumulation stone MSS connecting block / GOF top cover	G021138	1	
MSS elbow 90° with lining, double-layered	R013061	1	
MSS elbow 90°	R013018	1	
MSS elbow 90°	R013005	3	
MSS outlet block ø 180 with sealing	R013067	1	
MSS steel tape ring, packaging steel tape 16 x 0,5	R013020	9	
MSS glue Thermofix 1000 1 kg	900133	2	
MSS heat storage module 20 cm	R013001	1	
MSS elbow 90°	R013019	2	
MSS handle with rotating part	R013170	1	

Available variants:

MSS heat storage set standing on top suitable for:			
GOF 35x35 + GOT 51/52/52-ZL side-opening door	SET211507		1773,00

Note: For top-mount MSS kits in connection with door frame and flush casing, it is necessary to plan a wall thickness of ≤ 20 mm

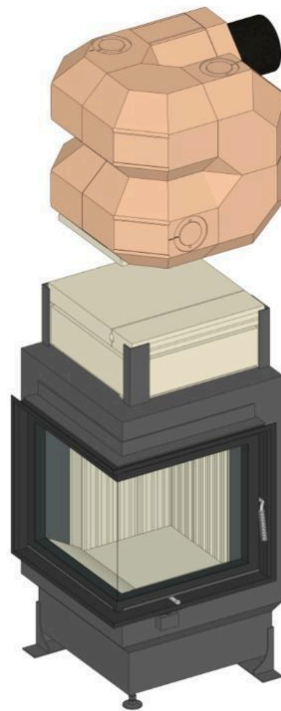

MSS heat storage set standing on top 330 kg



Set consists of:	Art.-Nr.	No.	Price
Accumulation stone MSS connecting block / GOF top cover	G021138	1	
MSS elbow 90° with lining, double-layered	R013061	1	
MSS elbow 90° with cleanout top	R013019	2	
MSS outlet block ø 180 with sealing	R013067	1	
MSS elbow 90°	R013005	3	
MSS steel tape ring, packaging steel tape 16 x 0,5	R013020	14	
MSS glue Thermofix 1000 1 kg	900133	2	
MSS heat storage module 20 cm	R013001	1	
MSS heat storage module with lining 20 cm, double-layered	R013065	1	
MSS heat storage module 10 cm	R013002	4	
MSS elbow 90° with cleanout right	R013017	1	
MSSI insulating block 30x30 cm	R013108	1	
MSSI insulating block 20x30 cm	R013107	2	
MSS base plate 100 30x30 cm	R013124	3	
MSS handle with rotating part	R013170	1	

Available variants:

MSS heat storage set standing on top suitable for:		
GOF 50x35 + GOT 45/67/44-ZL lifting door	SET211455	2513,00

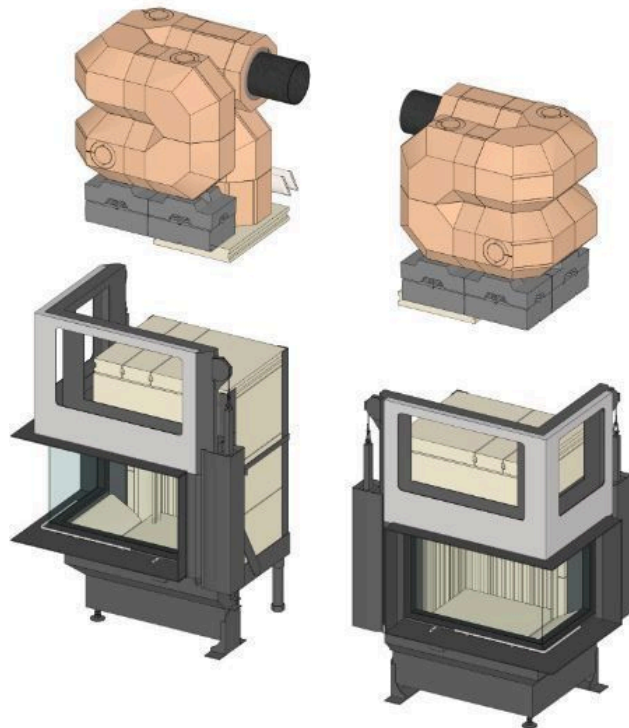

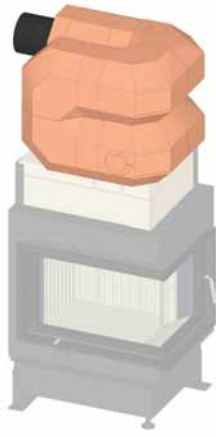

MSS heat storage set standing on top 330 kg

Set consists of:	Art.-Nr.	No.	Price
Accumulation stone MSS connecting block / GOF top cover	G021138	1	
MSS elbow 90° with lining, double-layered	R013061	1	
MSS outlet block ø 180 with sealing	R013067	1	
MSS elbow 90°	R013005	3	
MSS steel tape ring, packaging steel tape 16 x 0,5	R013020	13	
MSS glue Thermofix 1000 1 kg	900133	2	
MSS heat storage module 10 cm	R013002	4	
MSS heat storage module 20 cm	R013001	1	
MSS elbow 90°	R013019	2	
MSS elbow 90°	R013017	1	
MSS handle with rotating part	R013170	1	

Available variants:

MSS heat storage set standing on top suitable for:			
GOF 50x35 + GOT 45/67/44-ZL side-opening door	SET211506		2038,50

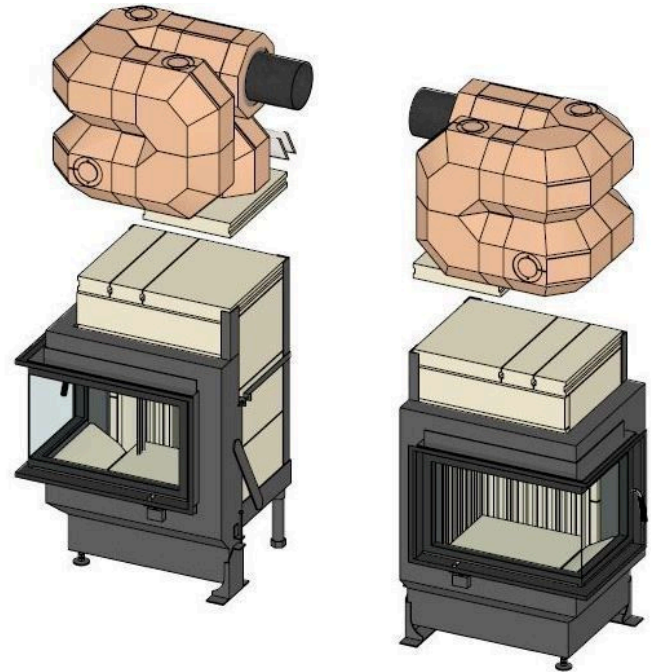

MSS heat storage set standing next at corner right side 390 kg

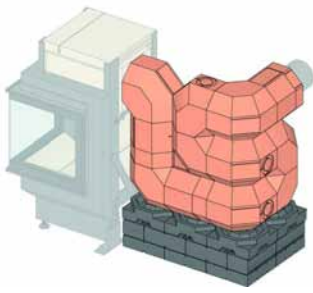

Set consists of:	Art.-Nr.	No.	Price
Accumulation stone MSS connecting block / GOF side	G023205	1	
MSS elbow 90° with lining, double-layered	R013061	1	
MSS elbow 90° with cleanout top	R013019	3	
MSS outlet block ø 180 with sealing	R013067	1	
MSS heat storage module 10 cm	R013002	2	
MSS elbow 90°	R013005	4	
MSS steel tape ring, packaging steel tape 16 x 0,5	R013020	15	
MSS glue Thermofix 1000 1 kg	900133	2	
MSS heat storage module 20 cm	R013001	2	
MSSI insulating block 30x30 cm	R013108	4	
MSS elbow 90° with opening top	R013007	1	
MSS bypass 30 with sealings	R013073	1	
MSS base plate 75 30x30 cm	R013123	4	
MSS base plate 100 30x30 cm	R013124	4	
MSS heat storage module 20 cm with opening	R013003	1	
MSS handle with rotating part	R013170	1	

Available variants:

MSS heat storage set standing next suitable for:		
GOF 35x35 + GOT 51/52/52-ZL side-opening door	SET211423	3053,00

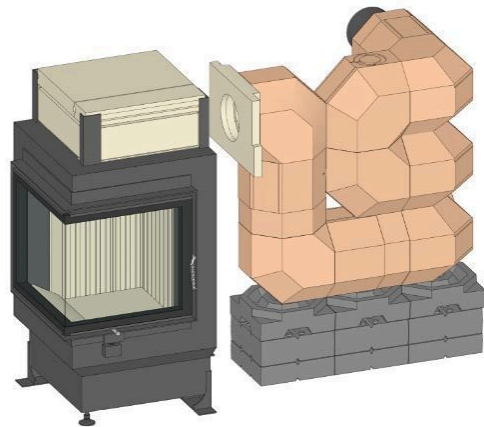

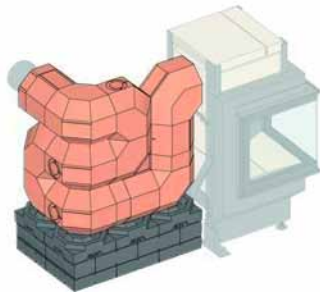

MSS heat storage set standing next at corner left side 390 kg

Set consists of:	Art.-Nr.	No.	Price
Accumulation stone MSS connecting block / GOF side	G023204	1	
MSS elbow 90° with lining, double-layered	R013061	1	
MSS elbow 90° with cleanout top	R013019	3	
MSS outlet block ø 180 with sealing	R013067	1	
MSS heat storage module 10 cm	R013002	2	
MSS elbow 90°	R013005	4	
MSS steel tape ring, packaging steel tape 16 x 0,5	R013020	15	
MSS glue Thermofix 1000 1 kg	900133	2	
MSS heat storage module 20 cm	R013001	2	
MSS insulating block 30x30 cm	R013108	4	
MSS elbow 90° with opening top	R013007	1	
MSS bypass 30 with sealings	R013073	1	
MSS base plate 75 30x30 cm	R013123	4	
MSS base plate 100 30x30 cm	R013124	4	
MSS heat storage module 20 cm with opening	R013003	1	
MSS handle with rotating part	R013170	1	

Available variants:

MSS heat storage set standing next suitable for:		
GOF 35x35 + GOT 51/52/52-ZL side-opening door	SET211422	3053,00

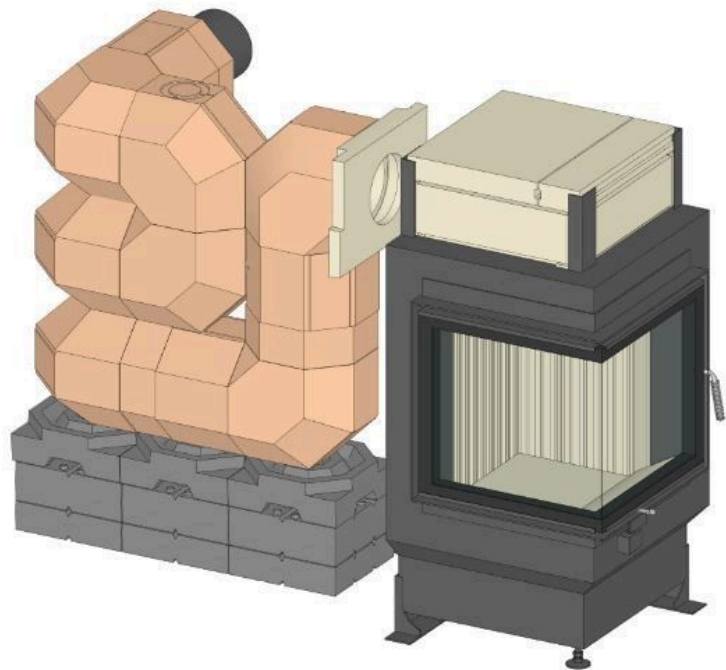

MSS heat storage set standing next at corner right side 390 kg

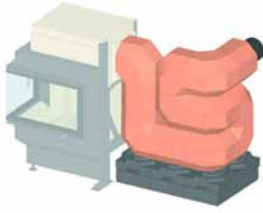

Set consists of:	Art.-Nr.	No.	Price
Accumulation stone MSS connecting block / GOF side	G023205	1	
MSS elbow 90° with lining, double-layered	R013061	1	
MSS elbow 90° with cleanout top	R013019	3	
MSS outlet block ø 180 with sealing	R013067	1	
MSS heat storage module 10 cm	R013002	2	
MSS elbow 90°	R013005	4	
MSS steel tape ring, packaging steel tape 16 x 0,5	R013020	15	
MSS glue Thermofix 1000 1 kg	900133	2	
MSS heat storage module 20 cm	R013001	2	
MSSI insulating block 30x30 cm	R013108	4	
MSS elbow 90° with opening top	R013007	1	
MSS bypass 30 with sealings	R013073	1	
MSS heat storage module 20 cm with opening	R013003	1	
MSS base plate 100 30x30 cm	R013124	4	
MSS handle with rotating part	R013170	1	

Available variants:

MSS heat storage set standing next suitable for:			
GOF 50x35 + GOT 45/67/44-ZL lifting door/side opening door	SET211436		2868,50

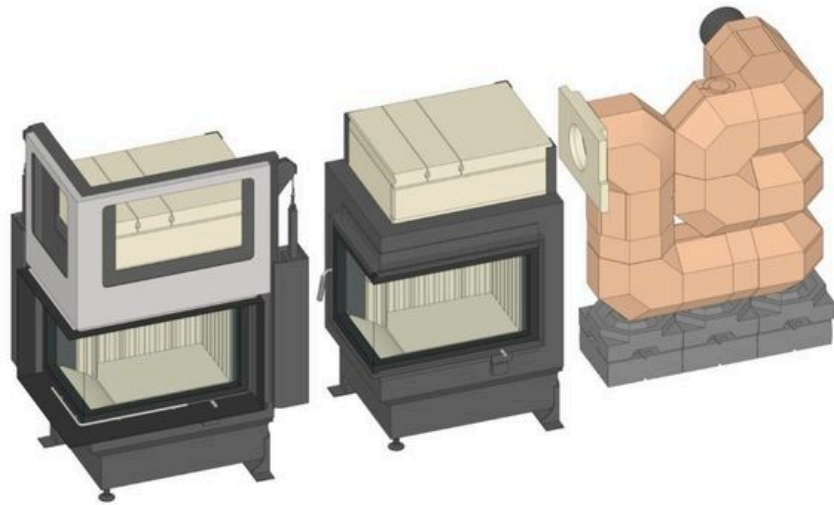

MSS heat storage set standing next at corner left side 390 kg

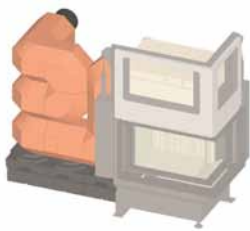

Set consists of:	Art.-Nr.	No.	Price
Accumulation stone MSS connecting block / GOF side	G023204	1	
MSS elbow 90° with lining, double-layered	R013061	1	
MSS elbow 90° with cleanout top	R013019	3	
MSS outlet block ø 180 with sealing	R013067	1	
MSS heat storage module 10 cm	R013002	2	
MSS elbow 90°	R013005	4	
MSS steel tape ring, packaging steel tape 16 x 0,5	R013020	15	
MSS glue Thermofix 1000 1 kg	900133	2	
MSS heat storage module 20 cm	R013001	2	
MSSI insulating block 30x30 cm	R013108	4	
MSS elbow 90° with opening top	R013007	1	
MSS bypass 30 with sealings	R013073	1	
MSS heat storage module 20 cm with opening	R013003	1	
MSS base plate 100 30x30 cm	R013124	4	
MSS handle with rotating part	R013170	1	

Available variants:

MSS heat storage set standing next suitable for:			
GOF 50x35 + GOT 45/67/44-ZL lifting door/side opening door	SET211502		2868,50

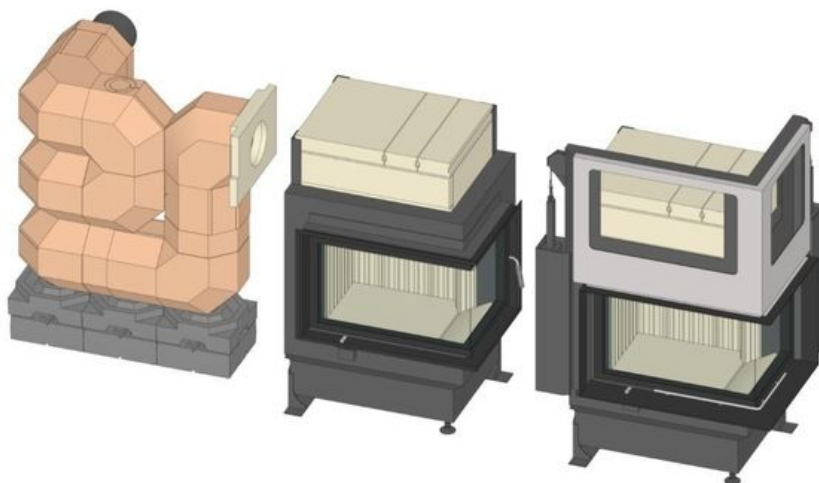

HKD

flat

Eck

Tunnel

MSS heat storage set standing next in the corner right side 410 kg



Set consists of:	Art.-Nr.	No.	Price
Accumulation stone MSS connecting block / GOF side	G023205	1	
MSS elbow 90° with lining, double-layered	R013061	1	
MSS elbow 90° with cleanout top	R013019	3	
MSS outlet block ø 180 with sealing	R013067	1	
MSS heat storage module 10 cm	R013002	2	
MSS elbow 90°	R013005	2	
MSS steel tape ring, packaging steel tape 16 x 0,5	R013020	18	
MSS glue Thermofix 1000 1 kg	900133	2	
MSS heat storage module 20 cm	R013001	5	
MSSI insulating block 30x30 cm	R013108	3	
MSS elbow 90° with opening top	R013007	2	
MSS bypass 30 with sealings	R013073	1	
MSS base plate 75 30x30 cm	R013123	4	
MSS base plate 100 30x30 cm	R013124	4	
MSSI insulating block 20x30 cm	R013107	1	
MSS heat storage module with lining 10 cm, double-layered	R013066	1	
MSS handle with rotating part	R013170	1	

Available variants:

MSS heat storage set standing next suitable for:		
GOF 35x35 + GOT 51/52/52-ZL side-opening door	SET211425	3252,00

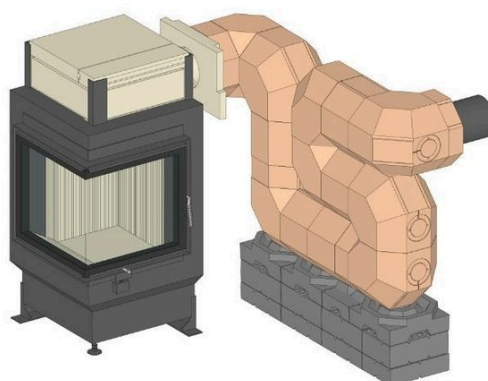

MSS heat storage set standing next in the corner left side 410 kg

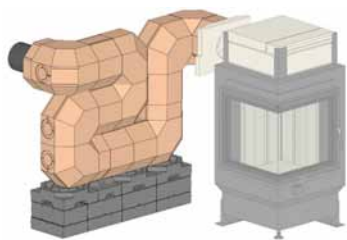

Set consists of:	Art.-Nr.	No.	Price
Accumulation stone MSS connecting block / GOF side	G023204	1	
MSS elbow 90° with lining, double-layered	R013061	1	
MSS elbow 90° with cleanout top	R013019	3	
MSS outlet block ø 180 with sealing	R013067	1	
MSS heat storage module 10 cm	R013002	2	
MSS elbow 90°	R013005	2	
MSS steel tape ring, packaging steel tape 16 x 0,5	R013020	18	
MSS glue Thermofix 1000 1 kg	900133	2	
MSS heat storage module 20 cm	R013001	5	
MSSI insulating block 30x30 cm	R013108	3	
MSS elbow 90° with opening top	R013007	2	
MSS bypass 30 with sealings	R013073	1	
MSS base plate 75 30x30 cm	R013123	4	
MSS base plate 100 30x30 cm	R013124	4	
MSSI insulating block 20x30 cm	R013107	1	
MSS heat storage module with lining 10 cm, double-layered	R013066	1	
MSS handle with rotating part	R013170	1	

Available variants:

MSS heat storage set standing next suitable for:		
GOF 35x35 + GOT 51/52/52-ZL side-opening door	SET211437	3252,00

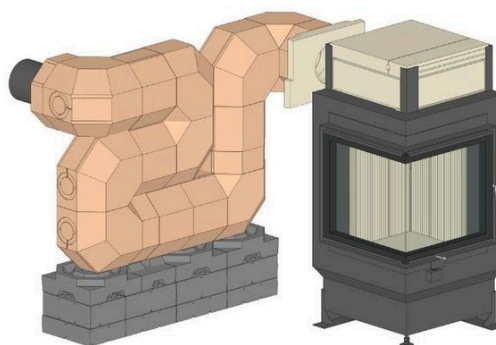

MSS heat storage set standing next in the corner right side 410 kg



Set consists of:	Art.-Nr.	No.	Price
Accumulation stone MSS connecting block / GOF side	G023205	1	
MSS elbow 90° with lining, double-layered	R013061	1	
MSS elbow 90° with cleanout top	R013019	3	
MSS outlet block ø 180 with sealing	R013067	1	
MSS heat storage module 10 cm	R013002	2	
MSS elbow 90°	R013005	2	
MSS steel tape ring, packaging steel tape 16 x 0,5	R013020	18	
MSS glue Thermofix 1000 1 kg	900133	2	
MSS heat storage module 20 cm	R013001	5	
MSSI insulating block 30x30 cm	R013108	3	
MSS elbow 90° with opening top	R013007	2	
MSS bypass 30 with sealings	R013073	1	
MSS base plate 100 30x30 cm	R013124	4	
MSSI insulating block 20x30 cm	R013107	1	
MSS heat storage module with lining 10 cm, double-layered	R013066	1	
MSS handle with rotating part	R013170	1	

Available variants:

MSS heat storage set standing next suitable for:		
GOF 50x35 + GOT 45/67/44-ZL lifting door/side opening door	SET211440	3081,50

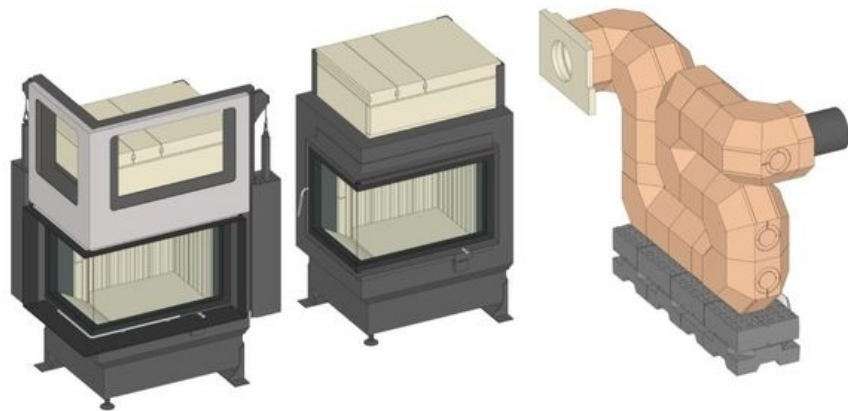

MSS heat storage set standing next in the corner left side 410 kg

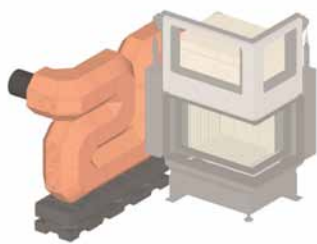

Set consists of:	Art.-Nr.	No.	Price
Accumulation stone MSS connecting block / GOF side	G023204	1	
MSS elbow 90° with lining, double-layered	R013061	1	
MSS elbow 90° with cleanout top	R013019	3	
MSS outlet block ø 180 with sealing	R013067	1	
MSS heat storage module 10 cm	R013002	2	
MSS elbow 90°	R013005	2	
MSS steel tape ring, packaging steel tape 16 x 0,5	R013020	18	
MSS glue Thermofix 1000 1 kg	900133	2	
MSS heat storage module 20 cm	R013001	5	
MSSI insulating block 30x30 cm	R013108	3	
MSS elbow 90° with opening top	R013007	2	
MSS bypass 30 with sealings	R013073	1	
MSS base plate 100 30x30 cm	R013124	4	
MSSI insulating block 20x30 cm	R013107	1	
MSS heat storage module with lining 10 cm, double-layered	R013066	1	
MSS handle with rotating part	R013170	1	

Available variants:

MSS heat storage set standing next suitable for:			
GOF 50x35 + GOT 45/67/44-ZL lifting door/side opening door	SET211505		3081,50

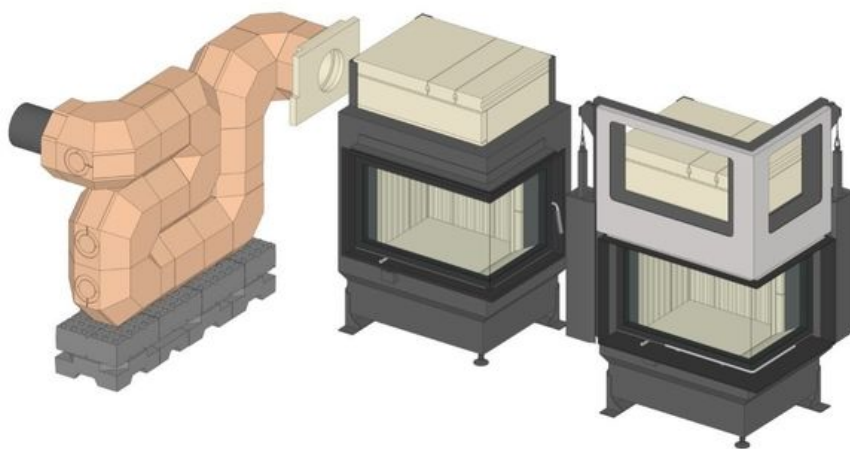

HKD

flat

Eck

Tunnel

Tunnel

HKD

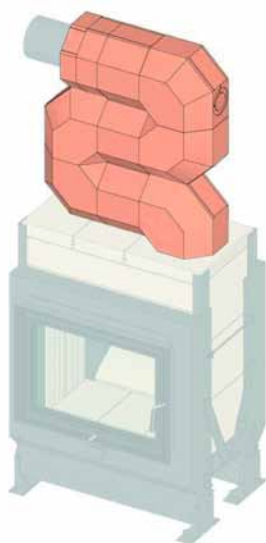

flat

MSS heat storage set standing on top 255 kg

Set consists of:	Art.-Nr.	No.	Price
Accumulation stone MSS connecting block / GOF top cover	G017110	1	
MSS elbow 90° with lining, double-layered	R013061	1	
MSS elbow 90° with cleanout top	R013019	2	
MSS outlet block ø 180 with sealing	R013067	1	
MSS heat storage module 10 cm	R013002	1	
MSS elbow 90°	R013005	2	
MSS steel tape ring, packaging steel tape 16 x 0,5	R013020	10	
MSS glue Thermofix 1000 1 kg	900133	2	
MSS heat storage module 20 cm	R013001	3	
MSS handle with rotating part	R013170	1	

Available variants:

MSS heat storage set standing on top suitable for:			
GOF Tunnel 66x36 + GOT 51/67-ZL 2 side-opening doors	SET211414		1708,00

With the MSS set a flue outlet can be realized either to the left or right side.

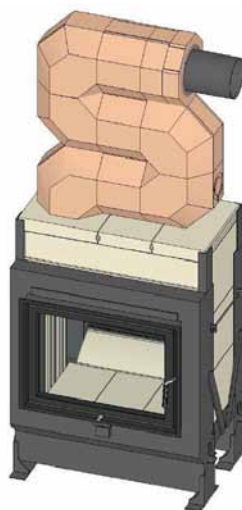

Eck

Tunnel

MSS heat storage set standing next 380 kg

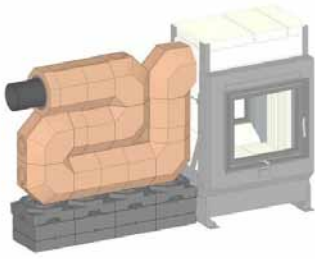

Set consists of:	Art.-Nr.	No.	Price
Accumulation stone MSS connecting block / GOF side	G015108	1	
MSS elbow 90° with lining, double-layered	R013061	1	
MSS elbow 90° with cleanout top	R013019	3	
MSS outlet block ø 180 with sealing	R013067	1	
MSS heat storage module 10 cm	R013002	2	
MSS elbow 90°	R013005	1	
MSS steel tape ring, packaging steel tape 16 x 0,5	R013020	16	
MSS glue Thermofix 1000 1 kg	900133	2	
MSS heat storage module 20 cm	R013001	6	
MSSSI insulating block 30x30 cm	R013108	4	
MSS elbow 90° with opening top	R013007	1	
MSS bypass 30 with sealings	R013073	1	
MSS base plate 75 30x30 cm	R013123	4	
MSS base plate 100 30x30 cm	R013124	4	
MSS heat storage module 20 cm with opening	R013003	1	
MSS handle with rotating part	R013170	1	

Available variants:

MSS heat storage set standing next suitable for:			
GOF Tunnel 66x36 + GOT 51/67-ZL 2 side-opening doors	SET211419		3033,50

The MSS accumulation block can be mounted either to the left or right side of the GOF

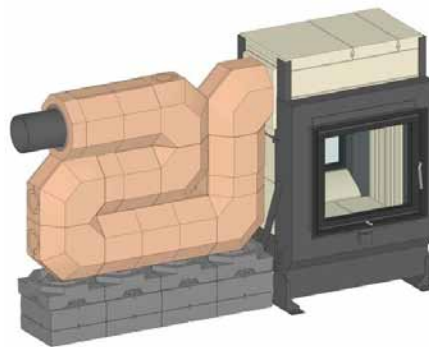

GNF Cast iron radiator

HKD



GNF 8

Set consists of:	Art.-Nr.	No.	Price
GNF 8 without connecting pieces		1	
Connecting piece, inletø 180		1	
Connecting piece, outletø 160		1	

Additional options			
Connecting piece, inletø 200	07140		75,50
Connecting piece, inletø 160	07136		75,50
Connecting piece, outletø 180	07139		75,50
Connecting piece, inletø 145	R014017		75,50
Connecting piece, outletø 145	R014013		75,50
Support bearing GNF 8	N002099		207,50
Heat protective screen for GNF in connection with DF 33	R014032		200,00

Available variants:

GNF 8	SET212336		1158,50
-------	-----------	--	----------------

flat

GNF 10



Set consists of:	Art.-Nr.	No.	Price
GNF 10 without connecting pieces		1	
Connecting piece, inlet ø 180		1	
Connecting piece, outlet ø 160		1	

Additional options			
Connecting piece, inlet ø 200	07140		75,50
Connecting piece, inlet ø 160	07136		75,50
Connecting piece, outlet ø 180	07139		75,50
Connecting piece, outlet ø 145	R014013		75,50
Support bearing GNF 10	10828		226,00

Available variants:

GNF 10	SET211449		1608,00
--------	-----------	--	----------------

Eck

Tunnel

Fireplace construction plates and mortars



Fireplace construction plates (single)

	Art.-Nr.	Price
Fireplace construction plate 250 x 1000 x 35	N007002	52,50
Fireplace construction plate 500 x 1000 x 35	N007003	104,50
Fireplace construction plate 500 x 750 x 35	N007004	78,50
Fireplace construction plate corner 250 x 250 x 125 x 35	N007005	50,50
Fireplace construction plate corner 500 x 250 x 125 x 35	N007006	84,00
Construction plate support profile 500 x 142 x 73 x 35	N007008	30,50

Fireplace construction plates (pallet)

	pallet/pcs.	Art.-Nr.	Price
Fireplace construction plate 250 x 1000 x 35	34	N007002-P	1690,50
Fireplace construction plate 500 x 1000 x 35	17	N007003-P	1690,50
Fireplace construction plate 500 x 750 x 35	26	N007004-P	1969,00
Fireplace construction plate corner 250 x 250 x 125 x 35	42	N007005-P	2042,50
Fireplace construction plate corner 500 x 250 x 125 x 35	42	N007006-P	3334,00
Construction plate support profile 500 x 142 x 73 x 35	17	N007008-P	461,00

Socle frame

	Art.-Nr.	Price
Corner connector for socle frame	D028220	99,00
Socle frame length element L = 1200 mm	D028215	346,50
Socle frame length element L = 1795 mm	D028229	495,50





Adhesive and plastering mortars Spezial 1100

	Art.-Nr.	Price
Adhesive and plastering mortars Spezial 1100 white 20 kg sack	900284	99,00
Adhesive and plastering mortars Spezial 1100 white 20 kg sack pallet = 48 sacks	900284P	4275,00
Glass fibre mesh (reinforcing mesh) 6x6	20079	214,00
Bucket with handle and lid for adhesive and plastering mortars Spezial 1100	900279	10,00



Adhesive and plastering mortars Universal 600

	Art.-Nr.	Price
Adhesive and plastering mortars Universal 600 pure white 20 kg sack	900384	76,50
Adhesive and plastering mortars Universal 600 pure white 20 kg sack pallet = 48 sacks	900384P	3295,50
Glass fibre mesh (reinforcing mesh) 6x6	20079	214,00
Bucket with handle and lid for adhesive and plastering mortars Universal 600	900386	10,00





Plaster Coat

	Art.-Nr.	Price
Plaster Coat 10 kg sack	902285	43,50
Plaster Coat 10 kg sack Pallet = 80 sacks	902285P	3299,50
Bucket with handle and lid for Plaster Coat	900387	10,00



Combustion chamber mortar

	Art.-Nr.	Price
Combustion chamber mortar FM1300 beige 10 kg bucket	900129	54,00



Materials for surface refinement

	Art.-Nr.	Price
Carnauba wax emulsion concentrate 0,5 l bottle	900285	35,00
Revisional materials BSK/BSO/KSO consisting of: japanese putty, sandpaper, 400 g filler, 250 g top coat	900300	28,00



Accessories construction material



	Art.-Nr.	Price
Special masking tape 50 m	02576	12,50

HKD

Flat

Eck

Tunnel

USA, EOS, EAS



USA 3

Article description	Art.-Nr.	Price
USA negative pressure safety device "USA-3"	E007068	1061,50
Accessories USA		
Smoke sensor connection for "USA"	E007063	256,00
Smoke sensor connection for "USA-2" in combination with MSS	E007058	78,50
Exhaust gas connection for "USA" in combination with ceramic storage	E007055-03	149,50
Mounting box	900001	17,00
Mounting box for dry wall installation	E004007-01	108,50
Negative pressure hose (by metre)	11602	14,50
Sensor wiring 2 lm	12120	34,00
Sensor wiring 3 lm	12121	45,50
Sensor wiring 4 lm	12122	54,00
Sensor wiring 5 lm	12123	62,00
Sensor wiring 7 lm	12125	81,50
Sensor wiring 10 lm	12124	114,00
Handmonitor for USA	900201	236,00

Article description	Art.-Nr.	Price
Collars for smoke pipes		
Concentric collar ø 150 mm	E007043-1	179,00
Concentric collar ø 130 mm	E007045-1	179,00
Concentric collar ø 180 mm	E007092-01	194,50



USA 4

Article description	Art.-Nr.	Price
USA negative pressure safety device "USA-4"	E007125	1009,00
Accessories USA		
Smoke sensor connection for "USA"	E007063	256,00
Smoke sensor connection for "USA-2" in combination with MSS	E007058	78,50
Exhaust gas connection for "USA" in combination with ceramic storage	E007055-03	149,50
Mounting box	901101	12,50
Mounting box for dry wall installation	901104	47,50
Negative pressure hose (by metre)	11602	14,50
Sensor wiring 2 lm	12120	34,00
Sensor wiring 3 lm	12121	45,50
Sensor wiring 4 lm	12122	54,00
Sensor wiring 5 lm	12123	62,00
Sensor wiring 7 lm	12125	81,50
Sensor wiring 10 lm	12124	114,00

Article description	Art.-Nr.	Price
Collars for smoke pipes		
Concentric collar ø 150 mm	E007043-1	179,00
Concentric collar ø 130 mm	E007045-1	179,00
Concentric collar ø 180 mm	E007092-01	194,50

USA, EOS, EAS



USA 4 Funk

Article description	Art.-Nr.	Price
USA negative pressure safety device USA-4 Funk	E007109	1548,50
with 1 x radio receiver		
Accessories USA 4 Funk		
Smoke sensor connection for "USA"	E007063	256,00
Smoke sensor connection for "USA-2" in combination with MSS	E007058	78,50
Exhaust gas connection for "USA" in combination with ceramic storage	E007055-03	149,50
Mounting box	901101	12,50
Mounting box for dry wall installation	901104	47,50
Negative pressure hose (by metre)	11602	14,50
Sensor wiring 2 lm	12120	34,00
Sensor wiring 3 lm	12121	45,50
Sensor wiring 4 lm	12122	54,00
Sensor wiring 5 lm	12123	62,00
Sensor wiring 7 lm	12125	81,50
Sensor wiring 10 lm	12124	114,00

Article description	Art.-Nr.	Price
Special accessory		
radio receiver, max. amount/USA: 3 radio receiver	E007065	416,50
Radio Repeater for USA 4 , signal amplifier	E007096	665,00

Article description	Art.-Nr.	Price
Collars for smoke pipes		
Concentric collar ø 150 mm	E007043-1	179,00
Concentric collar ø 130 mm	E007045-1	179,00
Concentric collar ø 180 mm	E007092-01	194,50



EOS 8

Article description		Art.-Nr.	Price
EOS 8 display- and control unit white	■	E004071	2099,50
EOS 8 display - and control unit black		E004073	2099,50
Mounting box			
Mounting box EOS/EAS/USA	■	900001	17,00
Mounting box for dry wall installation EOS/EAS/USA		E004007-01	108,50
Wall- mount box controll unit	■	902261	47,50
Connection door switch wiring EOS			
Door switch wiring EAS/EOS sensor wiring USA - 2 lm	■	12120	34,00
Door switch wiring EAS/EOS Fühlerleitung USA - 3 lm		12121	45,50
Door switch wiring EAS/EOS sensor wiring USA - 4 lm		12122	54,00
Door switch wiring EAS/EOS sensor wiring USA - 5 lm		12123	62,00
Door switch wiring EAS/EOS sensor wiring USA - 7 lm		12125	81,50
Door switch wiring EAS/EOS sensor wiring USA - 10 lm		12124	114,00
Connection thermocouple EOS			
Thermocouple wiring-T1/T3 2 lm	■	10958	37,00
Thermocouple wiring-T1/T3 3 lm		10959	49,00
Thermocouple wiring-T1/T3 4 lm		10960	59,00
Thermocouple wiring-T1/T3 5 lm		10961	73,00
Thermocouple wiring-T1/T3 7 lm		10963	92,50
Thermocouple wiring-T1/T3 10 lm		10962	128,50
Connection K1 to EOS			
Bus wiring-K1 2 lm	■	12150	52,00
Bus wiring-K1 3 lm		12151	62,00
Bus wiring-K1 4 lm		12152	71,00
Bus wiring-K1 5 lm		12153	80,50
Bus wiring-K1 7 lm		12154	93,50
Bus wiring-K1 10 lm		12155	121,00
motorized damper flap			
motorized damper flap D=180 mm	■	SET210596	897,50
motorized damper flap D=200 mm		SET210597	913,50
motorized damper flap D=250 mm		SET210598	927,00
Connection wiring K1-K2			
Connection wiring K1-K2 2 lm	■	E013009-2	47,00
Connection wiring K1-K2 3 lm		E013009-3	53,50
Connection wiring K1-K2 4 lm		E013009-4	60,00
Connection wiring K1-K2 5 lm		E013009-5	67,50
Connection wiring K1-K2 7 lm		E013009-7	82,00
Connection wiring K1-K2 10 lm		E013009-10	99,50

USA, EOS, EAS

Article description		Art.-Nr.	Price
Extended functionality sensors			
Thermocouple long with ceramic sleeve M12 and complete screw fitting (T1 and T3)	<input type="checkbox"/>	10994.1	200,00
Temperature sensor with immersion sleeve for water to smoke valve actuator (T2,T4,T6,T7)		10339	49,00
Connection display to control unit EOS			
Connection wiring EOS display-control unit - 2 lm	<input type="checkbox"/>	E013001-2	30,50
Connection wiring EOS display-control unit - 3 lm		E013001-3	33,00
Connection wiring EOS display-control unit - 4 lm		E013001-4	37,00
Connection wiring EOS display-control unit - 5 lm		E013001-5	40,50
Connection wiring EOS display-control unit - 7 lm		E013001-7	49,00
Connection wiring EOS display-control unit - 10 lm		E013001-10	58,50
Connection control unit to T2/T4 (screened cable)			
Extension wiring EWM/T2,T4,T6,T7 - 3 lm	<input type="checkbox"/>	E013013-01	45,50
Extension wiring EWM/T2,T4,T6,T7 - 5 lm		E013013-02	52,00
Extension wiring EWM/T2,T4,T6,T7 - 10 lm		E013013-03	75,50
Extension wiring EWM/T2,T4,T6,T7 - 15 lm		E013013-04	93,50
Connection EOS with BHZ			
Connection wiring EOS control unit BHZ and EWP - 0,7 lm	<input type="checkbox"/>	E013005-1	23,50
Connection wiring EOS control unit BHZ and EWP - 2 lm		E013005-2	27,50
Connection wiring EOS control unit BHZ and EWP - 3 lm		E013005-3	30,50
Connection wiring EOS control unit BHZ and EWP - 4 lm		E013005-4	33,00
Connection wiring EOS control unit BHZ and EWP - 5 lm		E013005-5	37,50
Connection wiring EOS control unit BHZ and EWP - 7 lm		E013005-7	43,50
Connection wiring EOS control unit BHZ and EWP - 10 lm		E013005-10	56,00
Flap actuator			
smoke valve actuator L/R - rotating with drive box	<input type="checkbox"/>	10338	821,50
Accessories flap actuator			
flexible Shaft 490 mm	<input type="checkbox"/>	10340	102,50
flexible Shaft 1200 mm		S004029	296,50
Control shaft d=8mm, length 360 mm for flue gas T-pipe		00669	89,00
Coupling 12/12 for elongation piece for square bar with flexible shaft		10273	16,50
Insulation for drive box / flap actuator "M2"		10329	111,00
Article description		Art.-Nr.	Price
Brunner Smart Home			
BSH Module Precondition: EOS 8		E004076	625,50

Extension board zur EOS

from
page
330



EAS

Article description		Art.-Nr.	Price
EAS 3 control unit with display	■	E005017	785,00
EAS 3 control unit without Display		E005018	593,00
Mounting box			
Mounting box EOS/EAS/USA	■	900001	17,00
Mounting box for dry wall installation EOS/EAS/USA		E004007-01	108,50
Connection door switch wiring EAS			
Door switch wiring EAS/EOS sensor wiring USA - 2 lm	■	12120	34,00
Door switch wiring EAS/EOS sensor wiring USA - 3 lm		12121	45,50
Door switch wiring EAS/EOS sensor wiring USA - 4 lm		12122	54,00
Door switch wiring EAS/EOS sensor wiring USA - 5 lm		12123	62,00
Door switch wiring EAS/EOS sensor wiring USA - 7 lm		12125	81,50
Door switch wiring EAS/EOS sensor wiring USA - 10 lm		12124	114,00
Connection thermocouple EAS			
Thermocouple wiring-T1/T3 2 lm	■	10958	37,00
Thermocouple wiring-T1/T3 3 lm		10959	49,00
Thermocouple wiring-T1/T3 4 lm		10960	59,00
Thermocouple wiring-T1/T3 5 lm		10961	73,00
Thermocouple wiring-T1/T3 7 lm		10963	92,50
Thermocouple wiring-T1/T3 10 lm		10962	128,50
Connection K1 to EAS			
Bus wiring-K1 2 lm	■	12150	52,00
Bus wiring-K1 3 lm		12151	62,00
Bus wiring-K1 4 lm		12152	71,00
Bus wiring-K1 5 lm		12153	80,50
Bus wiring-K1 7 lm		12154	93,50
Bus wiring-K1 10 lm		12155	121,00
motorized damper flap			
motorized damper flap D=180 mm	■	SET210596	897,50
motorized damper flap D=200 mm		SET210597	913,50
motorized damper flap D=250 mm		SET210598	927,00
Connection wiring K1-K2			
Connection wiring K1-K2 2 lm	■	E013009-2	47,00
Connection wiring K1-K2 3 lm		E013009-3	53,50
Connection wiring K1-K2 4 lm		E013009-4	60,00
Connection wiring K1-K2 5 lm		E013009-5	67,50
Connection wiring K1-K2 7 lm		E013009-7	82,00
Connection wiring K1-K2 10 lm		E013009-10	99,50

Contact.

Phone +49 8721 771-0

Export Sales + 49 8721 771- 250

export@brunner.de

Katharina Punzmann
Order processing - export

punzmann@brunner.de
Direct dialing ...-241

Ilona Witte
Order processing - export

ilona.witte@brunner.eu
Direct dialing ...-128

Service support + 49 8721 771-638

Markus Soutschek

soutschek@brunner.de

Ulrich Brunner GmbH
Zellhuber Ring 17 - 18
D-84307 Eggenfelden
www.brunner.de

BRUNNER products are offered and sold only by qualified dealers and service centres.

Stand 04/2023 Subject to technical and assortment changes. Errors excepted.

Subject to our "General terms and conditions of business". www.brunner.de/AGB

BRUNNER®